



# Liebert<sup>®</sup> STS2 / PDU

## User Manual

250A-800A, Three-Phase, 60 Hz

The information contained in this document is subject to change without notice and may not be suitable for all applications. While every precaution has been taken to ensure the accuracy and completeness of this document, Vertiv assumes no responsibility and disclaims all liability for damages result from use of this information or for any errors or omissions.

Refer to local regulations and building codes relating to the application, installation, and operation of this product. The consulting engineer, installer, and/or end user is responsible for compliance with all applicable laws and regulations relation to the application, installation, and operation of this product.

The products covered by this instruction manual are manufactured and/or sold by Vertiv. This document is the property of Vertiv and contains confidential and proprietary information owned by Vertiv. Any copying, use, or disclosure of it without the written permission of Vertiv is strictly prohibited.

Names of companies and products are trademarks or registered trademarks of the respective companies. Any questions regarding usage of trademark names should be directed to the original manufacturer.

### **Technical Support Site**

If you encounter any installation or operational issues with your product, check the pertinent section of this manual to see if the issue can be resolved by following outlined procedures.

Visit <https://www.vertiv.com/en-us/support/> for additional assistance.

# TABLE OF CONTENTS

<b>1 Important Safety Instructions</b> .....	<b>1</b>
<b>2 Unpacking and Inspection</b> .....	<b>3</b>
2.1 External Inspections .....	3
2.2 Unloading and Handling .....	3
2.2.1 Handling Considerations .....	4
2.2.2 Unit Preparation .....	4
2.3 Internal Inspection .....	5
<b>3 Location Considerations</b> .....	<b>7</b>
3.1 Recommended Minimum Service Clearances .....	7
3.2 Heat Output .....	7
3.3 Operating Environment .....	7
3.4 Altitude .....	8
<b>4 Locating the Vertiv™ Liebert® STS2 / PDU</b> .....	<b>9</b>
4.1 Anchoring the Unit to the Floor .....	9
4.2 Positioning the 250A Only Liebert® STS2/PDU™ Without Anchoring .....	9
<b>5 Power and Control Wiring</b> .....	<b>11</b>
5.1 Input and Output Power Connections .....	11
5.2 System Grounding .....	14
5.3 Control Wiring Connections .....	14
5.4 Remote Source Selection Wiring .....	14
5.5 Power Supply .....	15
<b>6 Output Power Wiring</b> .....	<b>17</b>
6.1 Customer Connections .....	17
<b>7 Options</b> .....	<b>19</b>
7.1 Programmable Relay Board .....	19
7.2 Input Contact Isolator Board .....	20
7.3 Comms Board .....	20
7.4 Vertiv™ Liebert® IntelliSlot Unity Card .....	21
7.5 Remote Source Selection .....	21
7.6 Key Lockout Switch .....	21
7.7 Static Switch Redundant Output Breaker .....	21
7.8 Inline Panelboards .....	21
7.9 I-Line Panelboards .....	22
7.10 Subfeed Breakers .....	22
7.11 K-Factor Transformers .....	22
7.12 Surge Suppression System .....	22
<b>8 Installation Drawings</b> .....	<b>23</b>
<b>9 Introduction to Vertiv™ Liebert® STS2 / PDU Operation</b> .....	<b>79</b>

- 9.1 System Description ..... 79
  - 9.1.1 Redundancy ..... 79
  - 9.1.2 Reliability and Agency Requirements ..... 80
  - 9.1.3 Factory Backup and Service Assistance ..... 80
- 9.2 Mode of Operations ..... 81
  - 9.2.1 Normal (Preferred Source) ..... 81
  - 9.2.2 Transfer ..... 81
  - 9.2.3 Transfer Inhibit ..... 81
  - 9.2.4 Bypass ..... 81
- 9.3 Operator Controls ..... 81
- 10 Theory of Operations ..... 83**
- 10.1 General Description ..... 83
  - 10.1.1 Liebert® Static Transfer Switch 2/Power Distribution Unit ..... 83
  - 10.1.2 Source Transfer ..... 83
  - 10.1.3 Automatic Transfer/Retransfer ..... 83
  - 10.1.4 Emergency Transfer ..... 84
  - 10.1.5 Load Current Transfer Inhibit ..... 84
  - 10.1.6 SCR Failure ..... 84
  - 10.1.7 On/Off Sequence ..... 84
- 10.2 Detailed Component Description ..... 85
  - 10.2.1 Controls ..... 85
  - 10.2.2 Circuit Breakers and Non-Automatic Circuit Breakers ..... 86
  - 10.2.3 SCRs ..... 86
  - 10.2.4 Logic Modules ..... 86
  - 10.2.5 Audible Alarm ..... 86
  - 10.2.6 RS-232 Port ..... 86
- 11 Operating Instructions ..... 87**
- 11.1 Normal System Turn-On ..... 87
- 11.2 Manual Transfer/ Preferred Source Selection ..... 89
- 11.3 Enabling Remote Source Selection ..... 90
- 11.4 Maintenance Bypass ..... 90
  - 11.4.1 Bypass Procedures for Source 1 ..... 91
  - 11.4.2 Bypass Procedures for Source 2 ..... 92
- 11.5 Normal System Shutdown ..... 93
  - 11.5.1 Shutdown in Static Transfer Switch Mode ..... 93
  - 11.5.2 Shutdown in Maintenance Bypass Mode ..... 93
- 12 Alarms and Faults ..... 95**
- 12.1 Event Mask ..... 95
- 12.2 Event and History Logs ..... 96
  - 12.2.1 Event Log ..... 96
  - 12.2.2 History Log ..... 96



12.3 Alarm Notes .....	97
12.4 List of Messages .....	97
<b>13 Communication Interfaces .....</b>	<b>101</b>
13.1 Using the RS-232 Port .....	101
13.1.1 Connecting and Using a Terminal .....	102
13.1.2 Configuring the Vertiv™ Liebert® STS2 / PDU via the Terminal .....	103
13.1.3 Setting Bitpacked Options With the Terminal .....	106
13.1.4 Setting Event Masks with the Terminal .....	109
<b>14 Touchscreen Display .....</b>	<b>111</b>
14.1 Display Overview .....	111
14.2 Menu Overview .....	112
14.2.1 Security .....	113
14.3 Mimic Display .....	114
14.4 Event Controls .....	114
14.5 Event Display .....	114
14.6 Menu Bar .....	114
14.7 Configuration Menu .....	114
14.7.1 Logs .....	132
14.7.2 Source Transfers .....	133
14.7.3 Startup Procedure .....	134
14.7.4 Bypass Procedure .....	134
14.7.5 Help .....	134
14.7.6 Logo .....	134
14.8 Cleaning the LCD Touchscreen .....	134
<b>15 Specifications .....</b>	<b>135</b>
15.1 System Configuration .....	135
15.1.1 Frequency .....	135
15.1.2 Input Voltage .....	135
15.1.3 Output Voltage .....	135
15.1.4 System Current Ratings .....	135
15.1.5 Grounding .....	136
15.1.6 Electrical Requirements .....	136
15.1.7 Surge Suppression .....	137
15.1.8 Response Time .....	137
15.1.9 Environmental Requirements .....	137
15.2 System Components .....	137
15.2.1 Frame and Enclosure .....	137
15.2.2 Casters - 250A only .....	137
15.2.3 Cooling .....	138
15.2.4 Access .....	138
15.2.5 Circuit Breakers .....	139

- 15.2.6 Cable Entrance .....139
- 15.2.7 Doors ..... 139
- 15.2.8 Color Graphical Display ..... 139
- 15.2.9 RS-232 Port .....139
- 15.2.10 Terminal Port Connections ..... 139
- 15.2.11 RS-232 Interface Parameters .....140
- 15.2.12 Maintenance Bypass .....140
- 15.2.13 Fuseless Design ..... 141
- 15.2.14 Options ..... 141
- 16 Event Message Help Text ..... 143**
- 17 Maintenance ..... 167**
- 17.1 Proper Tightening of Nuts and Bolts .....167
- 17.2 Testing the Liebert® STS2/PDU™ .....167
- 17.3 Changing the Air Filter .....167
- 18 Customer Settings ..... 169**
- 18.1 Programmable Relay Board Settings ..... 169
- 18.2 Input Contact Isolator Settings .....170

# 1 Important Safety Instructions

Save These Instructions

This manual contains important instructions that should be followed during the installation and maintenance of the Vertiv™ Liebert® STS2 / PDU (Static Transfer Switch 2/Power Distribution Unit).

Read this manual thoroughly, paying special attention to the sections that apply to your installation, before working with the Liebert® STS2 / PDU. Retain this manual for use by installing personnel.

Refer to [Handling Considerations](#) on page 4 before attempting to move the unit.



**WARNING! Risk of electric shock. Can cause injury or death.**

**Before proceeding with installation, read all instructions, verify that all the parts are included and check the nameplate to be sure the voltage matches available utility power.**

**This unit is supplied by more than one power source. The unit contains hazardous voltages if any of the input sources are on, even when the unit is in bypass. To isolate the unit, turn off and lock out all input power sources.**

**Verify that all input power sources are de-energized and locked out before making connections inside unit. Lethal voltages exist inside the unit during normal operation. Only qualified service personnel should perform maintenance on the Liebert® STS2 / PDU.**

**Installation and operation must comply with all national and local laws and regulations.**



**WARNING! Risk of electric shock. Can cause injury or death.**

**Under typical operation and with all Liebert® STS2 / PDU doors closed, only normal safety precautions are necessary. The area around the Liebert® STS2 / PDU should be kept free of puddles of water, excessive moisture, flammable liquids, gases, corrosive substances and debris.**

**Only properly trained personnel wearing appropriate safety headgear, gloves, shoes and glasses should perform maintenance on the Liebert® STS2 / PDU. When performing maintenance on any part of the equipment under power, service personnel and test equipment should be located on rubber mats. Service personnel should wear insulating shoes for isolation from direct contact with the floor.**

**One person should never work alone, even if all power is disconnected from the equipment. A second person should be standing by to assist and summon help in case of an accident.**

## NOTICE

Risk of damage from improper installation.

The input sources to the Liebert® STS2 / PDU must be grounded-wye sources. Input sources other than solidly grounded-wye sources may cause damage to the switch.

Liebert neither recommends nor knowingly sells this product for use with life support or other FDA-designated “critical” devices.

The Liebert® STS2 / PDU is suitable for indoor use only.

The unit is designed to operate from solidly grounded AC power sources only. Provide input over-current protection in accordance with the unit ratings. Wire and ground the unit according to national and local electrical safety codes. All wiring should be installed by a properly trained and qualified electrician.

A thorough equipment inspection and supervised startup by qualified service personnel are strongly recommended at these times:

1. Before unit is placed into service for the first time
2. After equipment relocation, and
3. After the unit has been de-energized for an extended period.



**WARNING! Risk of heavy unit falling over. Can cause equipment damage, injury or death.**

**Locate the center of gravity symbols and determine the unit's weight  before handling the cabinet. Read all instructions before attempting to move the unit, lift it, remove packaging or prepare the unit for installation.**

## NOTICE

This unit complies with the limits for a Class A digital device, pursuant to Part 15 Subpart J of the FCC rules and EN550022. These limits provide reasonable protection against harmful interference in a commercial environment. This unit generates, uses and radiates radio frequency energy and, if not installed and used in accordance with this instruction manual, may cause harmful interference to radio communications. Operating this unit in a residential area may cause harmful interference that the user must correct at his own expense.

## 2 Unpacking and Inspection

**NOTE:** Read the entire manual before beginning to install the Vertiv™ Liebert® STS2 / PDU. Upon delivery of the Liebert® STS2 / PDU, the installer should perform the following steps to ensure a high-quality installation.

### 2.1 External Inspections

1. While the Liebert® STS2 / PDU is still on the truck, inspect the equipment and shipping container(s) for any signs of damage or mishandling. Do not attempt to install the system if damage is apparent.
2. Upon receipt and before unpacking, inspect the shipping crate for damage or mishandling. Check the Shock-Watch indicator.
  - If the indicator is red, note the condition on shipper's receipt and check for concealed damage.
  - If any shipping damage is observed, file a damage claim with the shipper within 24 hours and contact your local Liebert representative or Vertiv at 1-800-543-2378 to inform them of the damage claim and the condition of the equipment.
3. Locate the bag containing the keys for the front access door. The bag is attached to the cabinet.
4. Compare the contents of the shipment with the bill of lading. Report any missing items to the carrier and to Vertiv immediately.
5. Check the nameplate on the cabinets to verify that the model numbers correspond with the one specified. Record the model numbers and serial numbers in the front of this installation manual. A record of this information is necessary should servicing be required.
6. If unit is to be stored before installation, it is recommended to store the unit in a dry environment with temperatures in the range of -40°F to 176°F (-40°C to 80°C). Use original packing materials or other suitable means to keep the unit clean. When opening the shipping crate, use care not to puncture the container with sharp objects.

### 2.2 Unloading and Handling



**WARNING!** Risk of heavy unit falling over. Can cause equipment damage, injury or death.

Locate the center of gravity symbols and determine the unit's weight  before handling the cabinet.

Read all instructions before attempting to move the unit, lift it, remove packaging or prepare the unit for installation.

Do not exceed a 15-degree tilt with the forklift. Read all instructions before attempting to move the unit, lift it, remove packaging or prepare the unit for installation.

#### NOTICE

When moving the unit by forklift, lift the unit from the rear so as to protect the front panel.

Also, if moving the unit by forklift or pallet jack after it has been removed from the pallet, be aware of the location of the casters and stabilizing feet (if the unit is so equipped) so as not to damage them.

Most Liebert® STS2 / PDU models are contained in one cabinet. The 800 amp units are contained in two cabinets, shipped on two pallets and connected together in the field.

The unit can be moved by forklift or pallet jack. However, because the weight distribution in the cabinet is uneven, use extreme care during handling and transporting.

See [Unit Preparation](#) on the next page for instructions on removing the Liebert® STS2 / PDU from the pallet.

## 2.2.1 Handling Considerations

The Vertiv™ Liebert® STS2 / PDU is bolted to a wood shipping pallet to allow handling by forklift or a pallet jack.



**WARNING! Risk of heavy unit falling over. Can cause equipment damage, injury or death. Exercise extreme care when handling Liebert® STS2 / PDU cabinets to avoid equipment damage or injury to personnel.**

**The cabinet can be safely tilted 15 degrees in any direction by forklift. If moving the unit up a ramp on its casters (if the unit is so equipped) or a pallet jack, ensure that the incline does not exceed 15 degrees.**

**Locate the center of gravity symbols and determine the unit's weight  before handling the cabinet.**

Check the unit size and weight. Refer to the cabinet drawings furnished with the unit for size and weight. Typical cabinet dimensions are shown in **Figure 8.1** on page 23 through **Figure 8.16** on page 47 . Typical unit crated weights are:

**Table 2.1 Shipping Weights (Typical)**

Model	Weight, lb. (kg)
250A	3813 (1733)
400A	4808 (2185)
600A	5892 (2678)
800A Module A*	4180 (1900)
800A Module B*	4723 (2147)
*800A ships on two separate pallets	

Plan the route. Review the route over which the unit will be transported to its installation location to ensure that all passages are large enough to accommodate the unit and support the weight.

Check for any non-negotiable corners or offsets in hallways. Before moving the unit to the intended location, review [Location Considerations](#) on page 7 .

## 2.2.2 Unit Preparation

The unit can be removed from the pallet before it is moved to its location.

Complete the following steps to properly remove the Liebert® STS2 / PDU from the shipping pallet:

1. Set the *pallet* in a level area with enough room to maneuver and remove the unit.
2. Remove the *bolts* holding the unit to the shipping pallet (located in the base of the unit).
3. Remove the *shipping blocks* from under the frame of the unit.
4. Use a *forklift* to raise the unit off the pallet and onto the floor. On the 250A unit ensure that the forklift is clear of the unit's casters and stabilizing feet. Lift the unit from the rear.
5. Conduct an *internal inspection* of the unit. See the list in [Internal Inspection](#) on the facing page .

## 2.3 Internal Inspection

After the Vertiv™ Liebert® STS2 / PDU has been unpacked, conduct an internal inspection:

1. Verify that *all items have been received*.
2. If spare parts were ordered, verify *their arrival*.
3. After the Liebert® STS2 / PDU has been removed from the pallet, open the door and remove cabinet panels to check for shipping damage to internal components.
4. Check for *loose connections* or *unsecured components in the cabinet(s)*.
5. Check for any *unsafe condition* that may be a potential safety hazard.

After the Liebert® STS2 / PDU has been inspected and no problems are found, the unit can be moved to its installation location. If using a forklift, remember to lift the unit from the rear.

This page intentionally left blank



## 3 Location Considerations

The Vertiv™ Liebert® STS2 / PDU should be placed in a clean, cool and dry location. The 250A unit without an output cabinet requires only front access for installation and maintenance. Both front and side access are required for installation and maintenance of 400-800A units and 250A units with output cabinet. The output cabinet comes factory-installed or either the right or left side, depending on how it was ordered. It cannot be moved from one side to the other in the field.

Adequate space is required above the unit for conduit (if configured as such) and cooling air flow. This section provides specific information for these considerations.

The unit is designed with top and bottom cable terminations to allow maximum flexibility in its installation. Units with output inline panelboards are bottom exit only. If bottom cable entry and exit is used, sufficient cable bending space must be provided by a raised floor or a floor stand.

For dimensions of each unit, see **Figure 8.1** on page 23 through **Figure 8.16** on page 47 . If your unit is equipped with an optional key lockout switch, see **Figure 8.7** on page 32 through **Figure 8.15** on page 45 for the location of that switch.

### 3.1 Recommended Minimum Service Clearances

The recommended service clearances are at the front and side, if equipped with output cabinet. The minimum service clearance required by the National Electrical Code (NEC) Article 110-26 is 36 in. (91cm) for units with voltages up to 150V to ground and 42 in. (107cm) for units with voltages over 150V to ground. Clearance of at least 18 in. (46cm) is required above the unit for cooling air flow.

### 3.2 Heat Output

The unit produces minimal heat during normal operation.

**Table 3.1 Heat Output**

Switch Size	Heat Output BTU/Hr (kW)
250A	11,737 (3.44)
400A	19,295 (5.66)
600A	29,238 (8.57)
800A	39,238 (11.50)

### 3.3 Operating Environment

The unit is designed to be installed indoors where the ambient air temperature is in the range of 32°F to 104°F (0°C - 40°C) with a relative humidity of 0% to 95% non-condensing, up to an altitude of 4000 feet (1200 meters).

### 3.4 Altitude

The standard units are designed for full load operation up to 4000 feet (1200m) above sea level. See **Figure 3.1** below for recommended deratings for altitudes greater than 4000 feet (1200m).

**Figure 3.1 Recommended Derating for High Altitude Operation**

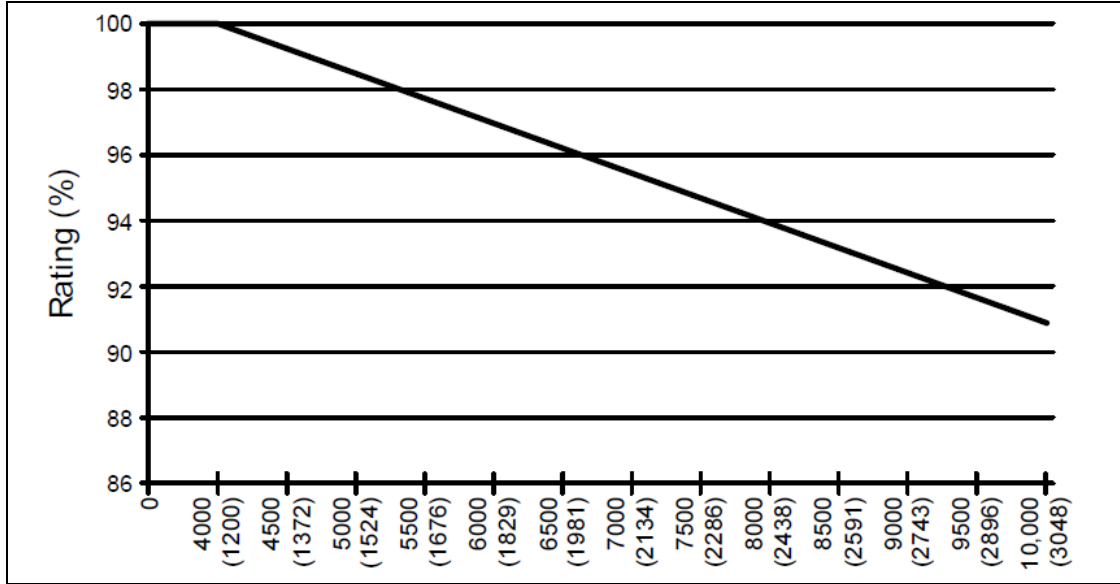

Operation at full load at a higher altitude can be accommodated in ambient temperatures less than 104°F (40°C) ambient.

## 4 Locating the Vertiv™ Liebert® STS2 / PDU

This section provides instructions for leveling the Liebert® STS2 / PDU and anchoring the unit to the floor, should that be required.

### 4.1 Anchoring the Unit to the Floor

The Liebert® STS2 / PDU can be anchored to the concrete floor to ensure stability for the unit in the event of seismic activity.

### 4.2 Positioning the 250A Only Liebert® STS2/PDU™ Without Anchoring

The 250A Liebert® STS2 / PDU is furnished with casters and stabilizing feet. After final positioning of the unit, adjust the stabilizing feet located in each corner of the frame base to stabilize the unit.

For stabilizing feet details, see Figures **Figure 8.1** on page 23 through **Figure 8.5** on page 28 .

This page intentionally left blank

## 5 Power and Control Wiring



**WARNING! Risk of electric shock. Can cause injury or death.**

**This unit is supplied by more than one power source. The unit contains hazardous voltages if any of the input sources are on, even when the unit is in bypass. To isolate the unit, turn off and lock out all input power sources.**

**Verify that all input power sources are de-energized and locked out before making connections inside unit. Lethal voltages exist inside the unit during normal operation. Only qualified service personnel should perform maintenance on the Vertiv™ Liebert® STS2 / PDU.**

**All power and control wiring must be installed by a licensed, properly trained and qualified electrician. All power and control wiring must comply with the National Electrical Code and all applicable local codes.**

The input power busbars are accessible through the front of the unit. Liebert's 250A units have PEM nut inserts designed to allow one-handed tightening. Busbars in the 400-800A units are supplied with holes to accommodate two-hole lugs.

Cables can be installed through the top or bottom of the unit through removable conduits plates. Units with output inline panelboards are bottom exit only for output cables.

Unless otherwise labeled, use the recommended tightening torque shown in **Table 17.1** on page 167. See Figures **Figure 8.6** on page 30 through **Figure 8.15** on page 45 for wiring entrance locations.

### 5.1 Input and Output Power Connections

The input power connections are made to the busbars provided inside the unit (see **Figure 8.20** on page 51 through **Figure 8.25** on page 55). These busbars are accessible through the front of the unit.

Output power connections are handled two different ways, depending on the type of distribution used. Power connections on standard units with an output breaker are made to the busbars inside the unit. These busbars are accessible through the front on 250A units and on the side on 400-800A units. See **Figure 8.20** on page 51 through **Figure 8.25** on page 55 for details on the busbars. Power connections on units with panelboard distribution are made directly to the panelboard breakers. Busbars are provided in the output cabinet for ground and neutral connections.



**WARNING! Risk of electric shock. Can cause injury or death.**

**Verify that all input power and control circuits are de-energized and locked out before making connections inside unit.**

The two input power feeds (sources) to the Liebert® STS2 / PDU should be from two independent sources to avoid a common source failure.

To ensure proper operation of the Liebert® STS2 / PDU, the two input sources must be the same nominal voltage level and phase rotation.

For uninterrupted automatic transfer, the two input sources should be synchronized within 15 degrees.

#### NOTICE

The input sources to the Liebert® STS2 / PDU must be grounded-*wye* sources. Input sources other than solidly grounded *wye* sources may cause damage to the switch.

The Liebert® STS2 / PDU is designed for operation with three-wire, solidly grounded sources only.

See **Figure 5.1** below through 6 for typical one-line diagrams. Refer to **Figure 8.20** on page 51 through **Figure 8.25** on page 55 for electrical field connections on all units.

**Figure 5.1 Typical Vertiv™ Liebert® STS2 / PDU, One-line Diagram**

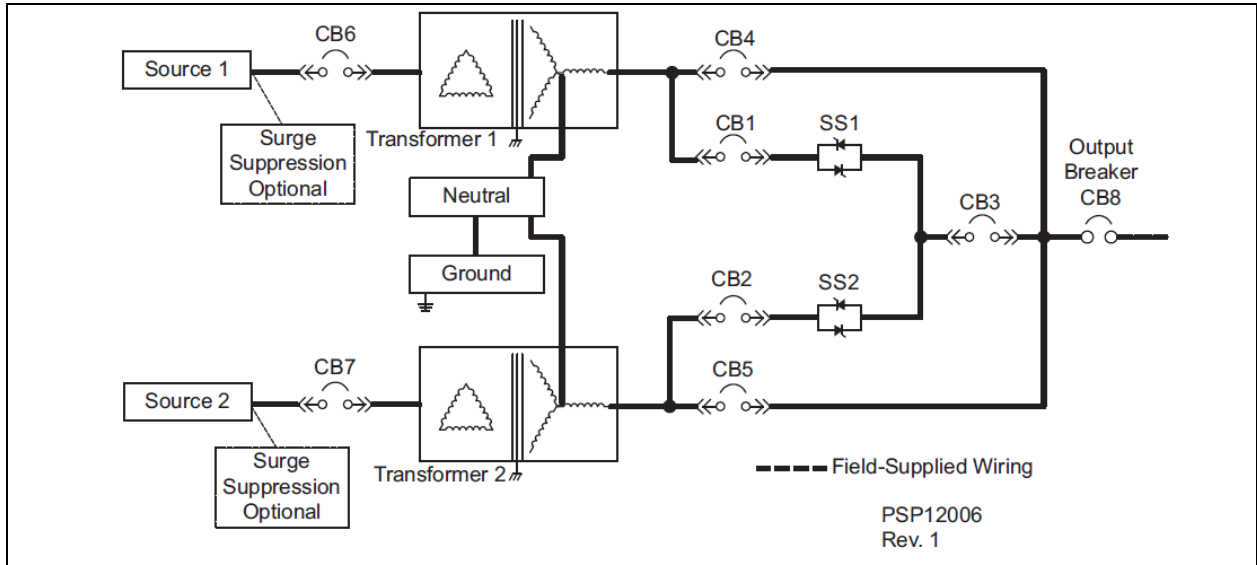

**Figure 5.2 Typical Liebert® STS2 / PDU, One-line Diagram, with Dual Static Switch Output Circuit Breakers (Not Available on 250A Units)**

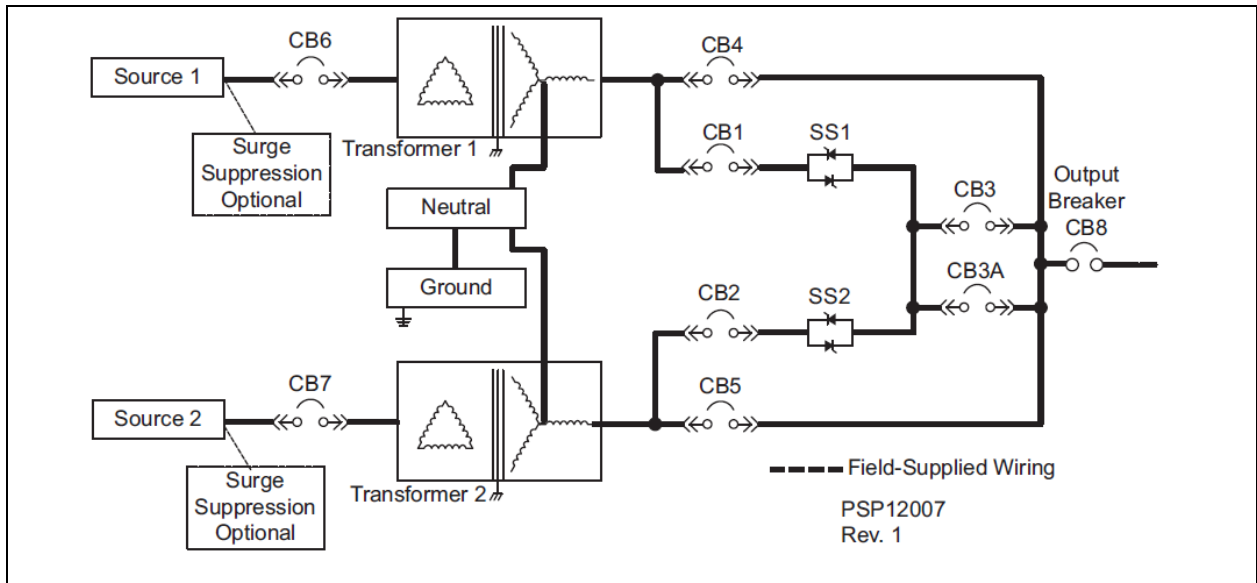

Figure 5.3 Typical Vertiv™ Liebert® STS2 / PDU, One-line Diagram, with Inline Distribution, Dual Static Switch Output Circuit Breakers

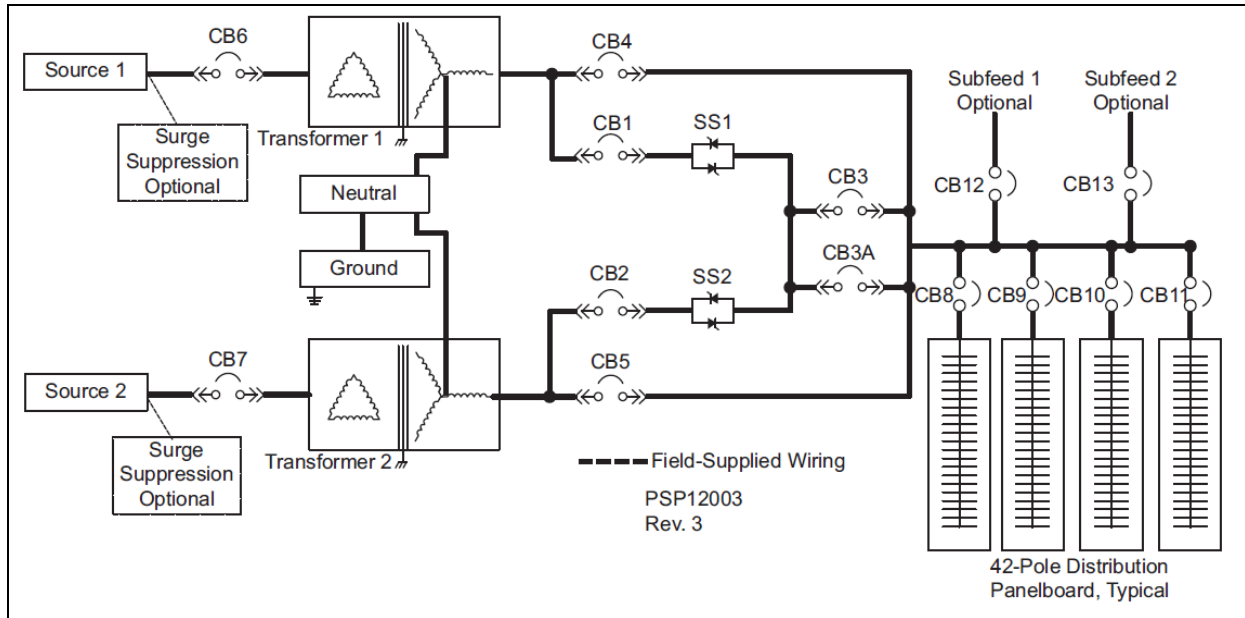
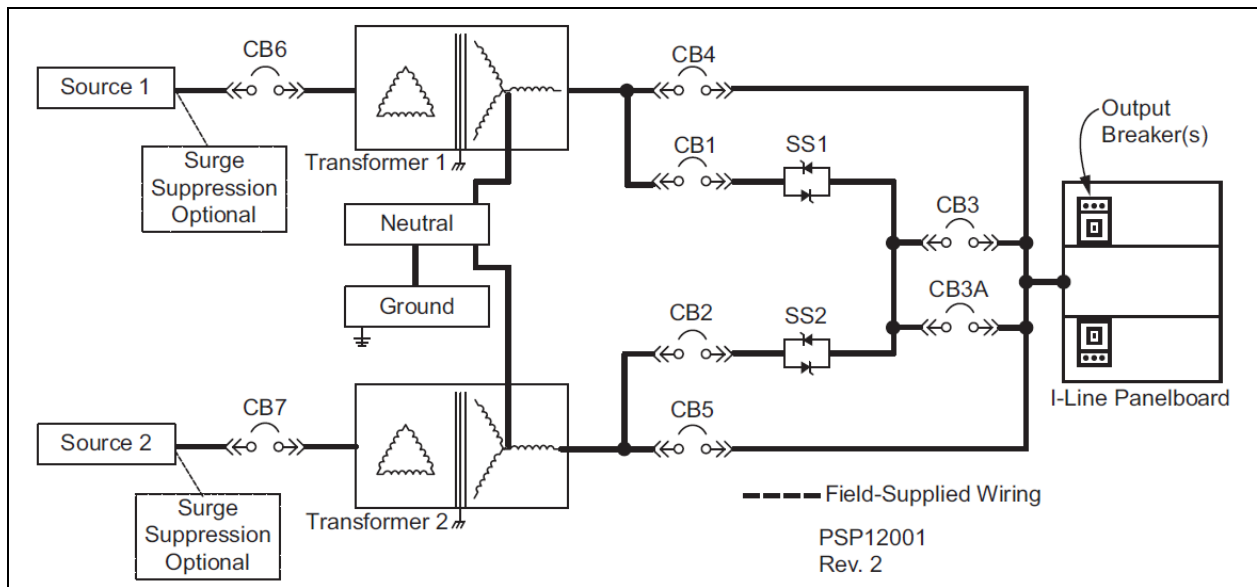

Figure 5.4 Typical Liebert® STS2 / PDU, One-line Diagram, with I-Line Distribution, Dual Static Switch Output Circuit Breakers



The input and output power wire size should be based on the overcurrent protection device, observing the NEC and local codes.

The Liebert® STS2 / PDU output power, ground and neutral busbars accommodate a wide range of wire sizes. Liebert® STS2 / PDU busbars accommodate standard two-hole lugs.

**Table 5.1 Input/Output Conduit Plate Specifications**

Rating	Maximum Number of Conduits	Size, in.
250A	12	2"
	8	2-1/2"
	6	3" or 3-1/2"
400-600A	6	2"
	4	2-1/2" or 3"
800A	6	2-1/2"
	5	3" or 3-1/2"

## 5.2 System Grounding

Equipment grounding—Grounding is primarily for equipment and personnel safety, although proper grounding also enhances equipment performance.

All input and output power feeds must include an equipment grounding means as required by the NEC and local codes.

An insulated equipment ground conductor is recommended to run with each input and output power feed. The equipment ground conductors should be at least the minimum size conductor per the NEC based on the upstream overcurrent protection device.



**WARNING! Risk of electric shock. Can cause injury or death.**

**If conduit is used as a grounding means, adequate electrical continuity must be maintained at all conduit connections. Using isolating bushings with a metal conduit can be a safety hazard.**

## 5.3 Control Wiring Connections

No control wiring is needed on the standard Vertiv™ Liebert® STS2 / PDU. Certain options and remote monitoring configurations require external control wiring. See [Options](#) on page 19 for details.

The customer must supply control wiring to the Liebert® STS2 / PDU for connection to any monitoring or communication options. Top and bottom removable conduit plates are provided for control wiring conduit.

Control cables can be installed through the top or bottom of the unit through removable control conduit plates. A top hat is provided on the 400-600A units for connecting the top entry control wiring conduits (see [Figure 8.7](#) on page 32 through [Figure 8.15](#) on page 45 ). The top hat is turned upside down and ships inside the unit. It must be removed from the unit and flipped 180 degrees before being reinstalled (see [Figure 8.43](#) on page 71 ). The control wiring top hat does NOT contain any knockouts for conduit. The installer must drill the appropriate-sized holes for the conduit before attaching to the top of the Liebert® STS2 / PDU.

See [Figure 8.41](#) on page 69 and [Figure 8.42](#) on page 70 for arrangement of optional cards.

## 5.4 Remote Source Selection Wiring

An optional Remote Source Selection board may be installed in your Liebert® STS2 / PDU. This board is installed in the same bay as the communications options. See [Figure 8.41](#) on page 69 and [Figure 8.42](#) on page 70 for the location of these options. See [Figure 8.49](#) on page 76 for information on the control wiring for the Remote Source Selection option.

The Remote Source Selection allows you choose the preferred input source from a remote location.



Terminal connections allow the customer to remotely select a source to be the preferred source in the same process as the local source transfer selection.

If both the input contacts are closed, the current selected preferred source shall be retained. If the unit's preferred source selection and Remote Source Selection are active at the same time, the Vertiv™ Liebert® STS2 / PDU follows the last request for a preferred source change, regardless of whether it was from the local or Remote Source Selection controls.

A six pin terminal block provides the Remote Source Selection connections. Two pairs of wires are used from the switch to trigger the source selection. You can select the type of switch used for this remote control. Connections are made to four of the connections, using Form A dry contacts. The contacts are numbered left to right:

**Table 5.2 Remote Source Selection Terminal Block**

Contact	Connection
1	Source 1
2	Isolated ground
3	Source 2
4	Isolated Ground
5	DO NOT USE
6	DO NOT USE

See [Enabling Remote Source Selection](#) on page 90 for instructions on enabling the Remote Source Selection option.

## 5.5 Power Supply

The Liebert® STS2 / PDU is supplied with redundant power supplies that are designed to operate from a voltage range of 200V to 600V. The unit is set at the factory to match the nameplate voltage. Field adjustments are not necessary. If the unit needs to operate at a voltage other than what is listed on the nameplate, contact Vertiv or your local Vertiv representative.

**Table 5.3** below provides transformer tap information.

**Table 5.3 Terminal block 1 and terminal block 2 wire connections**

Voltage	Connect		Connect		Jumper Between
	F1 TB1-XX	F2 TB1-YY	F3 TB2-XX	F4 TB2-YY	
200	1	9	1	9	1-7
220	2	12	2	12	6-8
380	1	8	1	8	2-7
415	1	10	1	10	4-7
600	1	12	1	12	6-7
208	1	10	1	10	1-7
240	1	11	1	11	1-7
400	1	9	1	9	3-7
480	1	11	1	11	5-7

**NOTICE**

Using **Table 5.3** on the previous page, ensure that the wiring for the control transformers matches the input voltage for the unit. Improper wiring could result in blown fuses.

## 6 Output Power Wiring

The Vertiv™ Liebert® STS2 / PDU standard model is provided with a circuit breaker for connecting to the load or a remote distribution cabinet. Other distribution configurations are available.

The three main types of distributions available for the Liebert® STS2 / PDU are:

- Output Breaker
- Inline Panelboards—two panelboards (84 poles) on 250A units and four panelboards (168 poles) on 400- 800A units. Square D and General Electric panelboards are available to accommodate bolt-in or plug-in breakers.
- Square D I-Line Panelboard—designed to accommodate up to 10 plug-in breakers from 100A to 250A. Additionally, 300A to 400A breakers are available on 800A units.

For other optional distribution methods, contact your local Liebert representative or call 1-800-LIEBERT.

The Liebert® STS2 / PDU distribution may be mounted on either the right or left side at the customer's option. Location of output conduit connections is affected by the location of the output cabinet. See **Figure 8.2** on page 24 , **Figure 8.3** on page 26 , **Figure 8.6** on page 30 , **Figure 8.7** on page 32 , **Figure 8.10** on page 36 and **Figure 8.11** on page 39 for wiring a right-side distribution configuration and **Figure 8.4** on page 27 , **Figure 8.5** on page 28 , **Figure 8.8** on page 33 , **Figure 8.9** on page 35 , **Figure 8.12** on page 40 and **Figure 8.13** on page 42 for wiring a left-side distribution configuration. See **Figure 8.17** on page 48 through **Figure 8.38** on page 66 for wiring.

See **Table 6.1** below for wiring the various output options.

### 6.1 Customer Connections

The customer is responsible for connections from the Liebert® STS2 / PDU distribution to the connected load, either directly or through remote distribution cabinets.

**Table 6.1 Distribution Configurations**

Distribution Type	For Details See Electrical Output Field Connections
<b>Output Breaker</b>	
250A	Figure 23
400-600A	Figure 33
800A	Figure 35
<b>Inline Panelboards</b>	
250A	Figure 30
400-800A	Figure 31
I-Line (Square D)	Figure 32

This page intentionally left blank

## 7 Options

This section discusses the options available for the Vertiv™ Liebert® STS2 / PDU. The communications options are also discussed in [Communication Interfaces](#) on page 101.



**WARNING! Risk of electric shock. Can cause injury or death.**

**All options must be installed by Vertiv or Vertiv factory-authorized service provided by a Vertiv distributor. The option area and customer control cable area contain hazardous voltages if any of the input sources are on, even when the unit is in bypass. Turn Off all power sources before installing customer control cables to any option.**

### 7.1 Programmable Relay Board

The programmable relay board (PRB) provides a means to trigger an external device when an event occurs in the Liebert® STS2 / PDU. Each PRB has 8 channels. Each channel has two sets of Form-C dry contacts, rated 1A @ 30VDC or 250mA @ 125VAC.

Any alarm or event may be programmed to any channel or channels. Up to ten (10) events may be programmed to a relay. If multiple events are grouped to one relay, group the events logically to simplify troubleshooting when an event is triggered. The same alarm or event may be programmed to more than one channel. Up to two programmable relay boards can be installed in the Liebert® STS2 / PDU for a total of 16 channels. Programming is performed through the touchscreen.

See [Configuring the Programmable Relay Board Settings](#) on page 127 for default settings and instructions for reconfiguring the relays. See [Figure 8.41](#) on page 69 and [Figure 8.42](#) on page 70 for the location of the PRB. See [Figure 8.44](#) on page 72 for wiring details. [Table 7.1](#) below provides the PRB pin-out.

**Table 7.1 Programmable Relay Board Pinout**

		Channel	Pin No.	C	N.C.	N.O.
TB1	CH1	A	1-3	1	2	3
		B	4-6	4	5	6
	CH2	A	7-9	7	8	9
		B	10-12	10	11	12
	CH3	A	13-15	13	14	15
		B	1-3	1	2	3
TB2	CH4	A	4-6	4	5	6
		B	7-9	7	8	9
	CH5	A	10-12	10	11	12
		B	13-15	13	14	15

**Table 7.1 Programmable Relay Board Pinout (continued)**

	Channel		Pin No.	C	N.C.	N.O.
TB3	CH6	A	1-3	1	2	3
		B	4-6	4	5	6
	CH7	A	7-9	7	8	9
		B	10-12	10	11	12
	CH8	A	13-15	13	14	15
		B	1-3	1	2	3
TB4						

Key: N.O. = Normally Open; N/C. = Normally Closed; C = Common Note: Pin 16 not used on TB1, TB2 and TB3.

## 7.2 Input Contact Isolator Board

The Input Contact Isolator Board (ICI) provides a Vertiv™ Liebert® STS2 / PDU module interface for up to eight external user alarm or message inputs to be routed through the Liebert® STS2 / PDU alarm network. The eight contacts are normally open dry contacts. When a contact closes, an event is triggered.

The Input Contact Isolator options are configured through the Input Contact Isolator dialog box, which is accessed from the Comm Option dialog box on the touchscreen. You also can program the alarm messages through this dialog box. See [Configuring the Input Contact Isolator Settings](#) on page 125 for instructions on configuring the connections.

See [Figure 8.41](#) on page 69 and [Figure 8.42](#) on page 70 for the location of the ICI. See [Figure 8.45](#) on page 73 for wiring details.

## 7.3 Comms Board

The Comms Board provides a communication interface to Vertiv™ Liebert® SiteScan™, site monitoring product and/or an external modem. Vertiv™ Liebert® SiteLink-12 or Liebert® SiteLink-4 is required for Liebert® SiteScan™ to communicate with the Liebert® STS2 / PDU.

The Comms Board is equipped with an RS-422 communication port for communication to a Liebert® SiteScan™ monitoring system using a 2-wire twisted pair for reliable communication up to 1000 meters (3281 feet). Information available from the RS-422 port includes the present switch status information, all monitoring parameters and all active alarms.

The Comms Board is equipped with a modem interface for remote reporting of the present switch status information, alarm history information and the history of status screens that are triggered upon a major alarm event. The monitoring system software also supports an auto-dial feature that allows the system to automatically dial programmed phone numbers by way of a modem to report designated alarm conditions.

Programming the Comms Board is performed through the touchscreen. See [Comm Options](#) on page 122 for details.

See [Figure 8.41](#) on page 69 and [Figure 8.42](#) on page 70 for the location of the Comms Board. See [Figure 8.46](#) on page 74 for information on the control wiring.

## 7.4 Vertiv™ Liebert® IntelliSlot Unity Card

A Liebert® IntelliSlot Unity Card enables external communications with the Vertiv™ Liebert® STS2 / PDU. The Liebert® IntelliSlot Unity Card enables SNMP, BACnet IP, BACnet MSTP, Modbus TCP, Modbus RTU, YDN23 and Web management capability to the Liebert® STS2 / PDU. The card employs Ethernet and RS-485 networks to monitor and manage a wide range of operating parameters, alarms and notifications.

See **Figure 8.41** on page 69 and **Figure 8.42** on page 70 for the location of the Liebert® IntelliSlot™ Unity™ Card. See **Figure 8.47** on page 75 for control wiring information.

If you have questions about the Vertiv™ Liebert® IntelliSlot™ Unity™ Card, refer to the user guide, SL-52645, available at Vertiv's Web site, [www.vertiv.com](http://www.vertiv.com).

## 7.5 Remote Source Selection

The Remote Source Selection allows the preferred input source to be chosen from a remote location. A user supplied normally open dry contact allows the user to remotely select a source to be the preferred source in the same process as the local source transfer selection.

If both the input contacts are closed, the current selected preferred source shall be retained. If the unit's preferred source selection and Remote Source Selection are active at the same time, the Liebert® STS2 / PDU follows the last request for a preferred source change, regardless of whether it was from the local or Remote Source Selection controls.

See [Enabling Remote Source Selection](#) on page 90 for instructions on enabling the Remote Source Selection.

See **Figure 8.41** on page 69 and **Figure 8.42** on page 70 for the location of the Remote Source Selection option.

See [Remote Source Selection Wiring](#) on page 14 and **Figure 8.49** on page 76 for information on the control wiring.

## 7.6 Key Lockout Switch

The key lockout switch activates a software lockout of the touchscreen to prevent manual transfers and configuration changes. When locked out, the touchscreen becomes a read-only display. A key is needed to do manual transfers or change settings.

The alarm silence button is not disabled when in the lockout position.

The switch is located on the front of the unit next to the display; it is behind the front door but can be operated without opening the front door. See **Figure 8.14** on page 43 through **Figure 8.16** on page 47 for the key lockout switch location on each unit.

See [Security](#) on page 113 and **Figure 14.4** on page 113 for instructions on using the key lockout switch.

## 7.7 Static Switch Redundant Output Breaker

A plug-in, non-automatic circuit breaker is provided which allows redundancy in the static switch output power path. The breaker is connected in parallel with the static switch output plug-in non-automatic circuit breaker.

## 7.8 Inline Panelboards

An output distribution cabinet with either Square D or General Electric inline panelboards with copper bus to accept bolt-in or plug-in circuit breakers. Each panelboard is individually protected by a 225A, 3-pole panelboard main circuit breaker.

Each panelboard includes a separate isolated neutral bus bar and a safety-ground bus bar for the neutral and safety-ground connections for at least 42 output circuits.

## 7.9 I-Line Panelboards

An output distribution cabinet with one vertically mounted Vertiv™ Liebert® Square D I-Line panelboard with copper bus to accept Square D three phase plug-in circuit breakers. The panelboard must be enclosed with an accent cover.

## 7.10 Subfeed Breakers

Breakers for feeding remote panelboard(s) or other loads. Available in ratings of 225A or 400A.

**NOTE: Only available on units with inline panelboards. 400A breaker not available on 250A units.**

## 7.11 K-Factor Transformers

U.S. Department of Energy compliant K20-rated double-shielded copper isolation transformer specially designed to accommodate highly nonlinear loads in accordance with UL 1561 (in place of standard isolation transformer).

## 7.12 Surge Suppression System

A fused and monitored high-energy, 80 kAmp/phase surge suppression system by Control Concepts connected to each input of the unit for superior surge suppression.



## 8 Installation Drawings

Figure 8.1 Outline Drawing, 250A Vertiv™ Liebert® STS2 / PDU

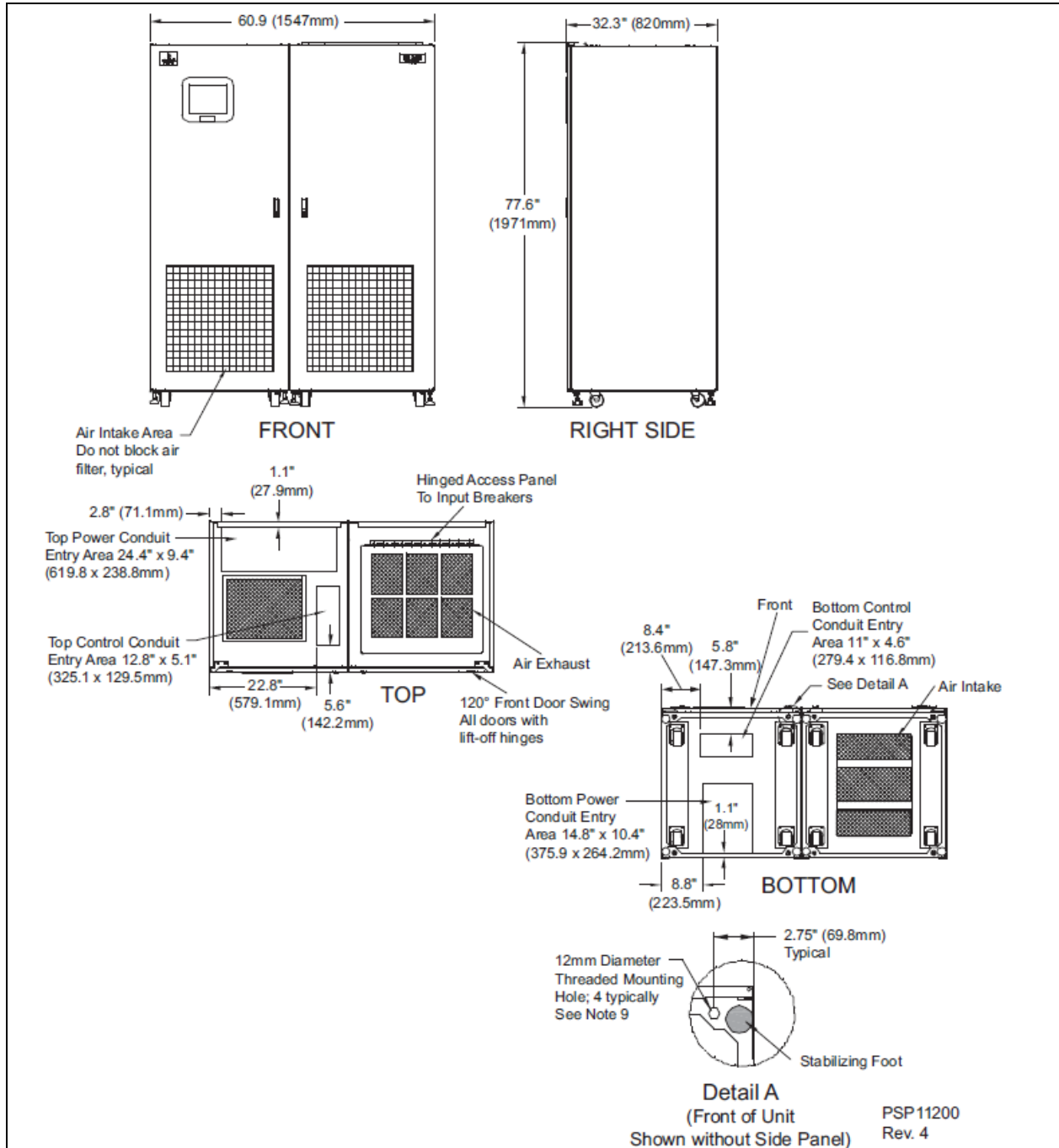

### NOTES TO FIGURE :

1. 18" (457mm) clearance above unit required for air exhaust
2. Installation and service access required in front only.
3. Approximate heat output: 11,737 BTU/Hr (3.44 kW).

4. Approximate weight: 3393 lb. (1542 kg)
5. Unit bottom is structurally adequate for forklift handling.
6. Keep cabinet within 15 degrees of vertical while handling.
7. Color: IBM off-white
8. Open door to replace air filter, disposable type, size: 1"x25"x25" (25 x 635x635mm)
9. Threaded mounting holes (see Detail A) are provided for seismic anchoring or floor stand. Mounting bolts must be threaded into the unit mounting holes from underneath the unit base. . If a floor stand is used, the casters must rest on the floor stand to support the unit's weight.
10. Top and bottom cable entry available through removable access plates. Remove, punch to suit conduit size and replace.

**Figure 8.2 Outline Drawing, 250A Vertiv™ Liebert® STS2 / PDU with Right Side I-Line Distribution**

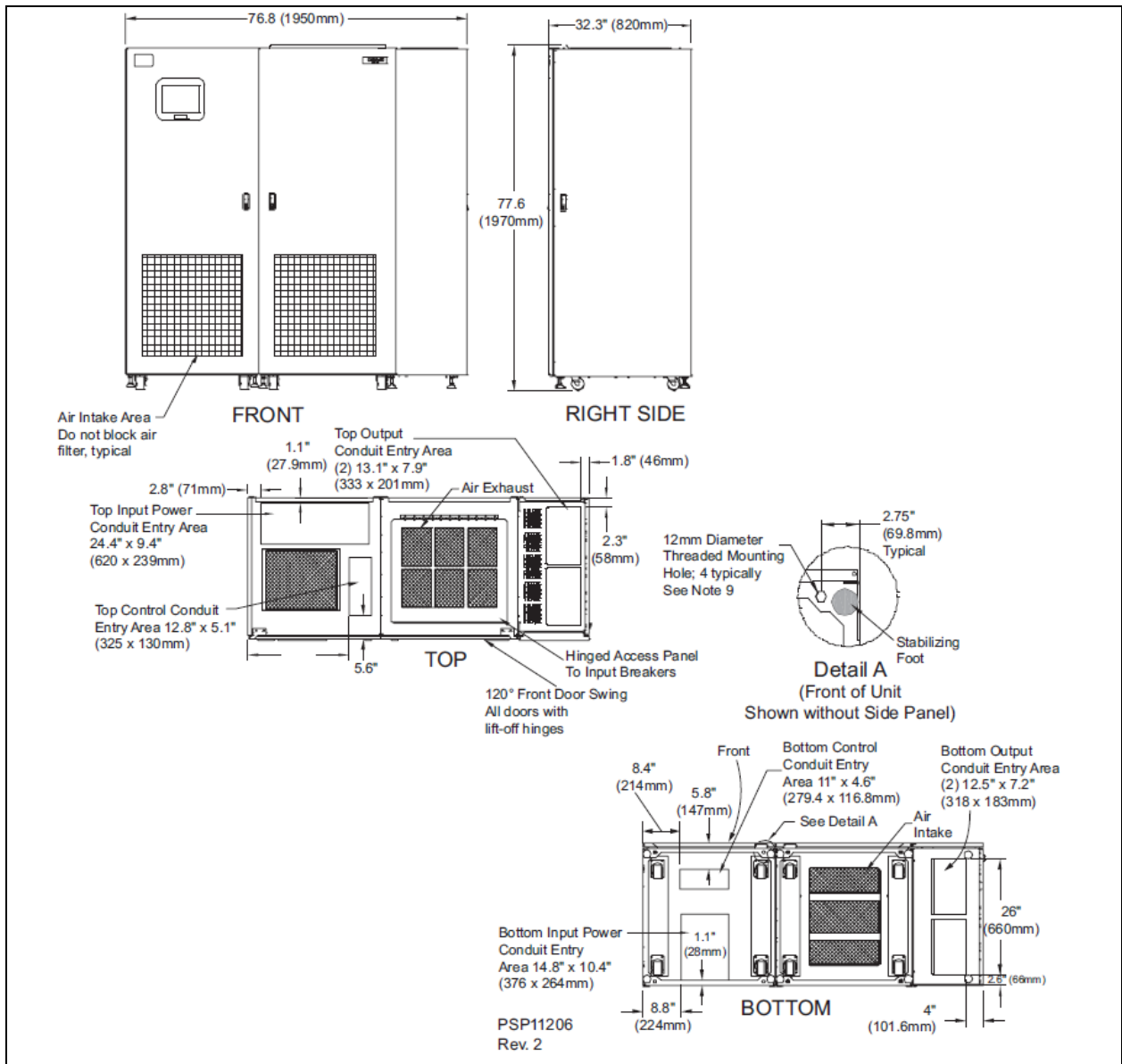

**NOTES TO FIGURE :**

1. 18" (457mm) clearance above unit required for air exhaust
2. Installation and service access required in front only.
3. Heat output: Approx. 11,737 BTU/hr (3.44kW).
4. Approximate weight: 3993 lb. (1815 kg).
5. Unit bottom is structurally adequate for forklift handling.
6. Keep cabinet within 15 degrees of vertical while handling.
7. Color: IBM off-white
8. Open door to replace air filter, disposable type, size: 1" x 25" x 25" (25 x 635 x 635mm).
9. Threaded mounting holes (see Detail A) are provided for seismic anchoring or floor stand. Mounting bolts must be threaded into unit mounting holes from underneath unit base. If a floor stand is used, the casters must rest on the floor stand to support the unit's weight.
10. Top and bottom cable entry available through removable access plates. Remove, punch to suit conduit size and replace.

Figure 8.3 Outline Drawing, 250A Vertiv™ Liebert® STS2 / PDU with Right Side Inline Distribution

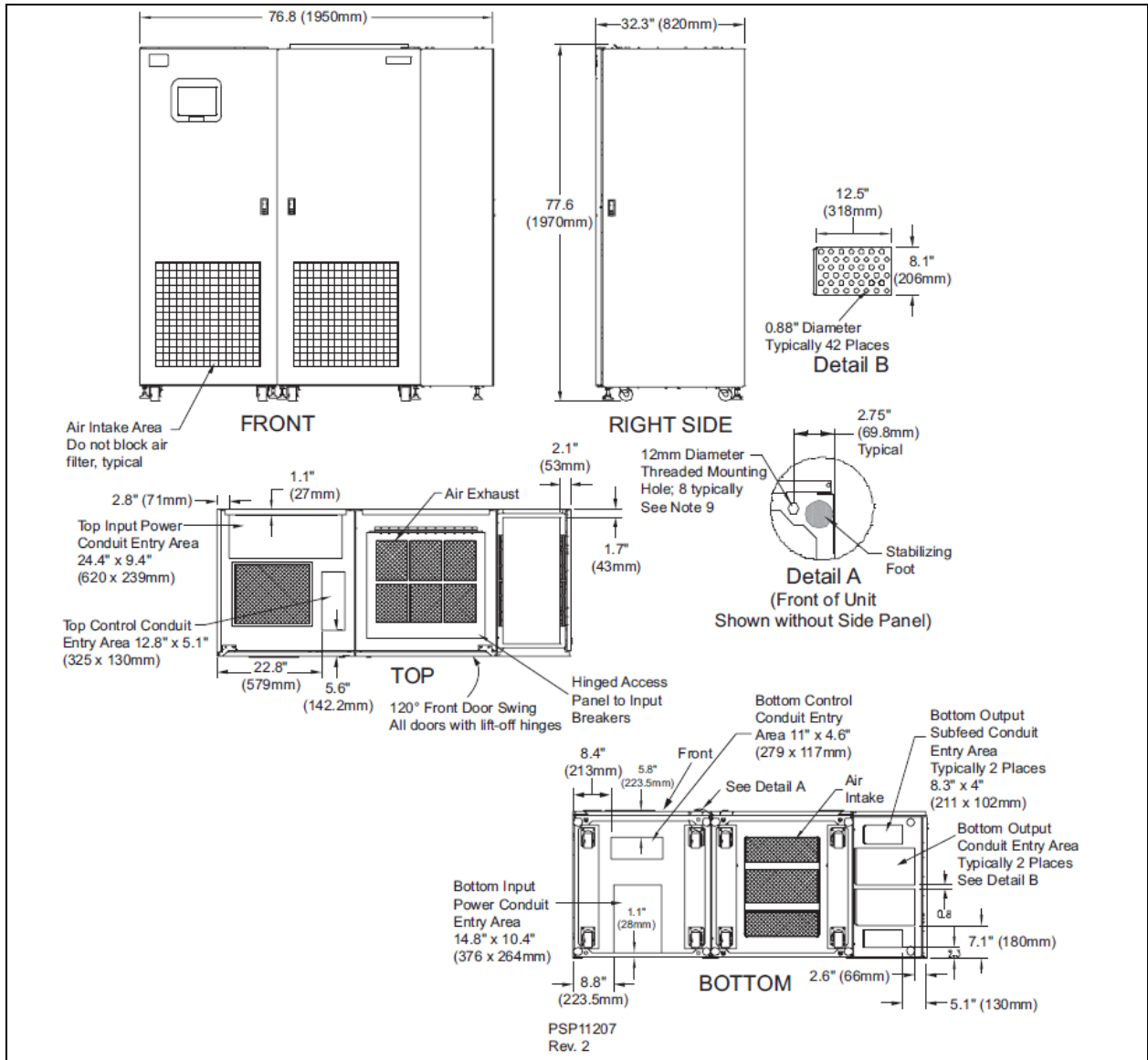

NOTES TO FIGURE :

1. 18" (457mm) clearance above unit required for air exhaust
2. Installation and service access required in front only.
3. Heat output: approx. 11,737 BTU/hr (3.44kW).
4. Approximate weight: 3993 lb. (1815 kg).
5. Unit bottom is structurally adequate for forklift handling.
6. Keep cabinet within 15 degrees of vertical.
7. Color: IBM off-white
8. Open door to replace air filter, disposable type, size: 1" x 25" x 25" (25 x 635 x 635mm).
9. Threaded mounting holes (see Detail A) are provided for seismic anchoring or floor stand. Mounting bolts must be threaded into unit mounting holes from underneath unit base. If a floor stand is used, the casters must rest on the floor stand to support the unit's weight.

10. Top and bottom cable entry available through removable access plates. Remove, punch to suit conduit size and replace.

Figure 8.4 Outline drawing, 250A Vertiv™ Liebert® STS2 / PDU with left side I-Line distribution

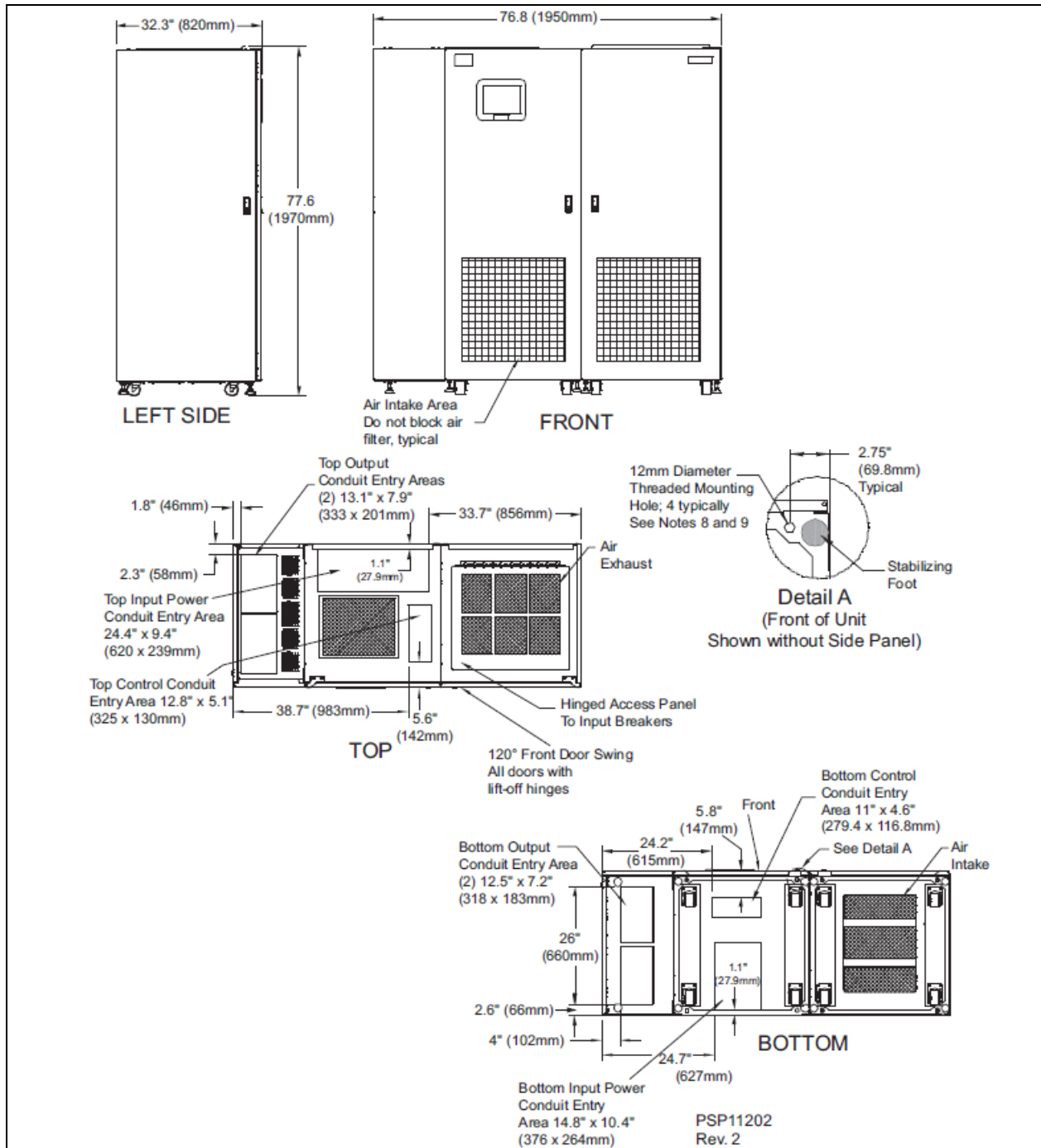

NOTE TO FIGURE:

1. 18" (457mm) clearance above unit required for air exhaust
2. Installation and service access required in front only.
3. Heat output, approximately 11,737 BTU/Hr (3.44kW).

4. Approximate weight: 3993 lb. (1815 kg).
5. Unit bottom is structurally adequate for forklift handling.
6. Keep cabinet within 15 degrees of vertical.
7. Color: IBM off-white
8. Open door to replace air filter, disposable type, size: 1" x 25" x 25" (25 x 635 x 635mm).
9. Threaded mounting holes are provided for seismic anchoring or floor stand. If a floor stand is used, the casters must rest on the floor stand to support the unit's weight.
10. Top and bottom cable entry available through removable access plates. Remove, punch to suit conduit size and replace.

**Figure 8.5 Outline Drawing, 250A Vertiv™ Liebert® STS2 / PDUwith Left Side Inline Distribution**

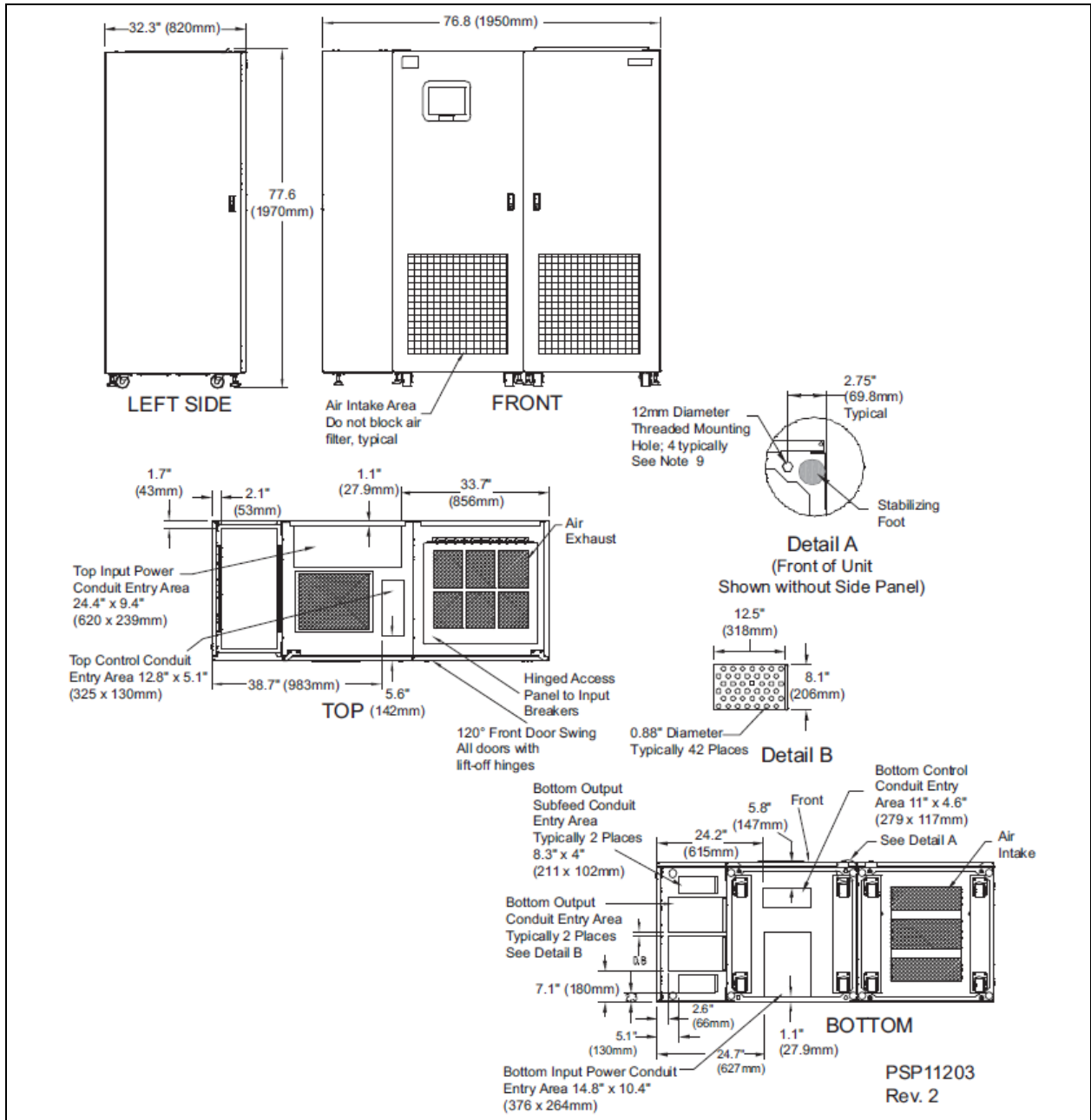

**NOTES TO FIGURE :**

1. .18" (457mm) clearance above unit required for air exhaust
2. Installation and service access required in front only.
3. Heat output approximately 11,737 BTU/hr (3.44kw).
4. Approximate weight: 3993 lb. (1815 kg).
5. Unit bottom is structurally adequate for forklift handling
6. Keep cabinet within 15 degrees of vertical.
7. Color: IBM off-white
8. Open door to replace air filter, disposable type, size: 1" x 25" x 25" (25 x 635 x 635mm).
9. Threaded mounting holes (see Detail A) are provided for seismic anchoring or floor stand. If a floor stand is used, the casters must rest on the floor stand to support the unit's weight.
10. Top and bottom cable entry available through removable access plates. Remove, punch to suit conduit size and replace.

Figure 8.6 Outline Drawing, 400-600A Vertiv™ Liebert® STS2 / PDU with right side inline distribution

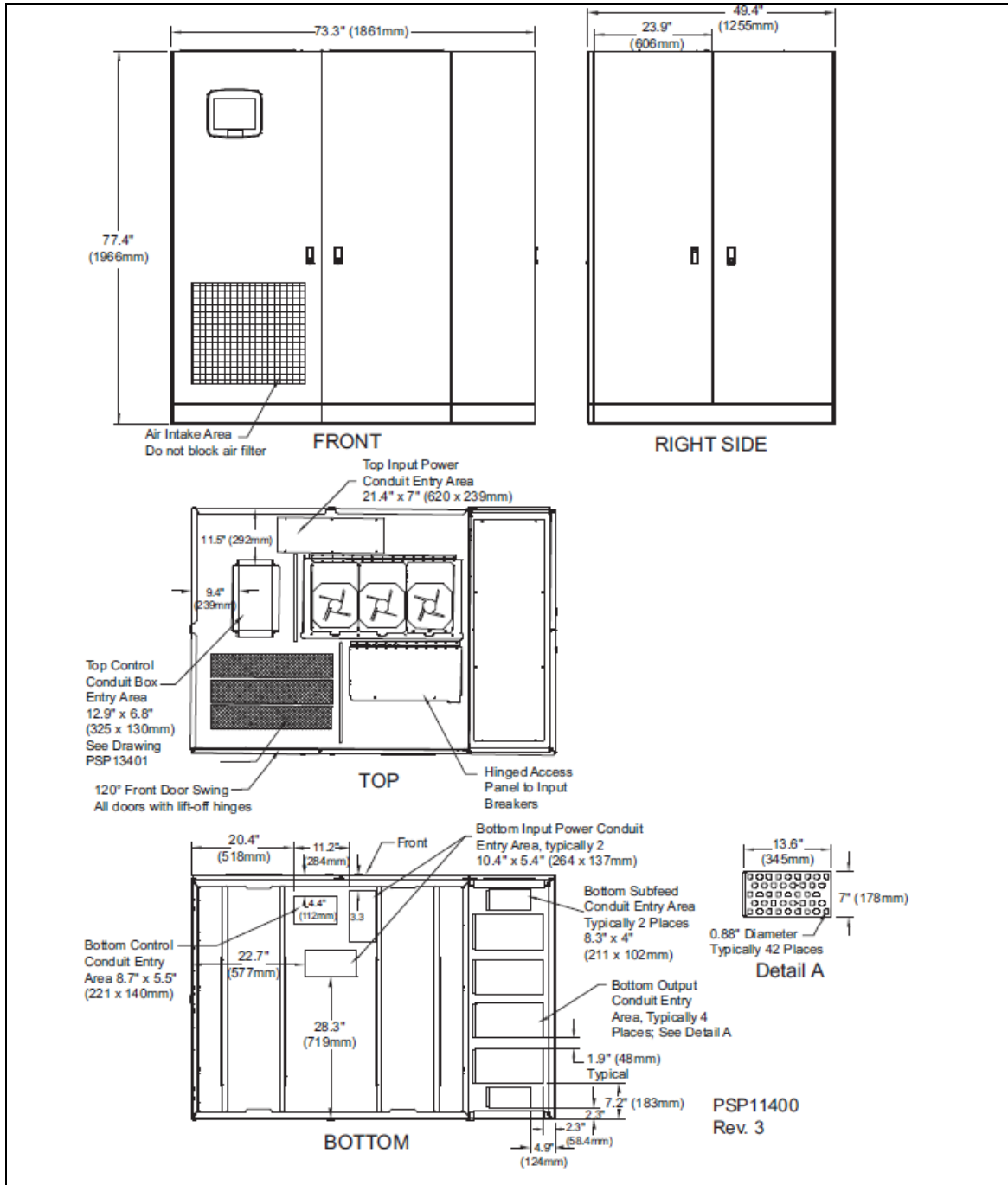



**NOTES TO FIGURE :**

1. Approximate weight:
  - 400A - 4608 lb. (2095kg),
  - 600A - 5692 lb. (2582kg).
2. 18" (457mm) clearance above unit required for air exhaust.
3. Installation and service access required in front and right side only.
4. Keep cabinet within 15 degrees of vertical.
5. Color - IBM off-white.
6. Approximate heat output:
  - 400A - 19,295 BTU/hr (5.66 kW)
  - 600A - 29,238 BTU/hr (8.57 kW).
7. Unit bottom is structurally adequate for forklift handling.
8. Open doors to replace air filter. Disposable type, size 1 x 25 x 25 (25 x 635 x 635mm).
9. Top and bottom cable entry available through removable access plates. Remove, punch to suit conduit size and replace.

Figure 8.7 Outline Drawing, 400-600A Vertiv™ Liebert® STS2 / PDU with Right Side Output Breaker or I-Line

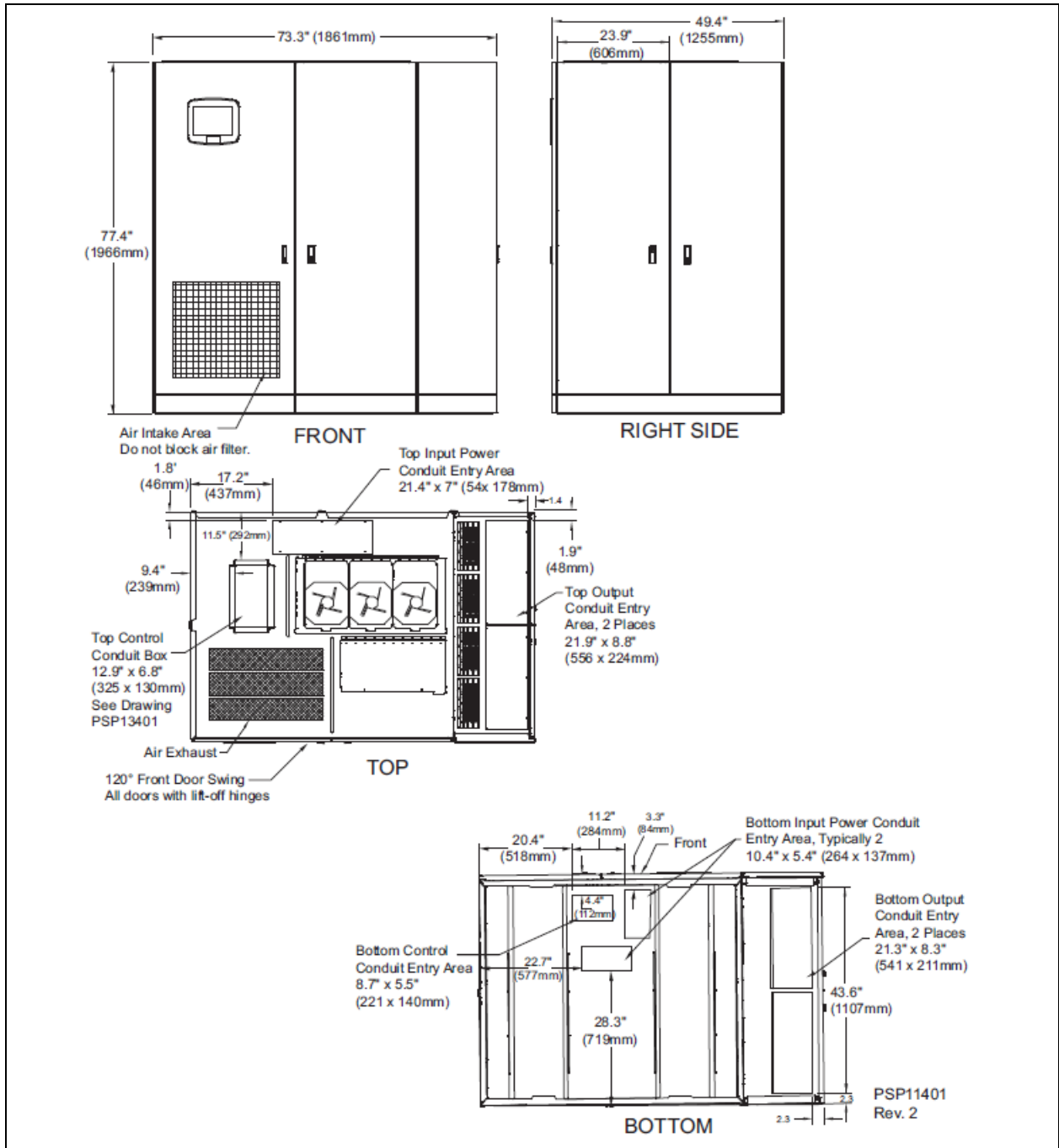

NOTES TO FIGURE :

1. Approximate weight:
  - 400A - 4608 lb. (2095kg)
  - 600A - 5692 lb. (2587kg).
2. 18" (457mm) clearance above unit required for air exhaust.
3. Installation and service access required in front and right side only.
4. Keep cabinet within 15 degrees of vertical.

5. Color - IBM off-white.
6. Approximate heat output:
  - 400A - 19,295 BTU/hr (5.66 kW)
  - 600A - 29,238 BTU/hr (8.57 kW).
7. Unit bottom is structurally adequate for forklift handling.
8. Open doors to replace air filter. Disposable type size 1 x 25 x 25 (25 x 635 x 635mm).
9. Top and bottom cable entry available through removable access plates. Remove, punch to suit conduit size and replace.

**Figure 8.8 Outline Drawing, 400-600A Vertiv™ Liebert® STS2 / PDU with Left Side Inline Distribution**

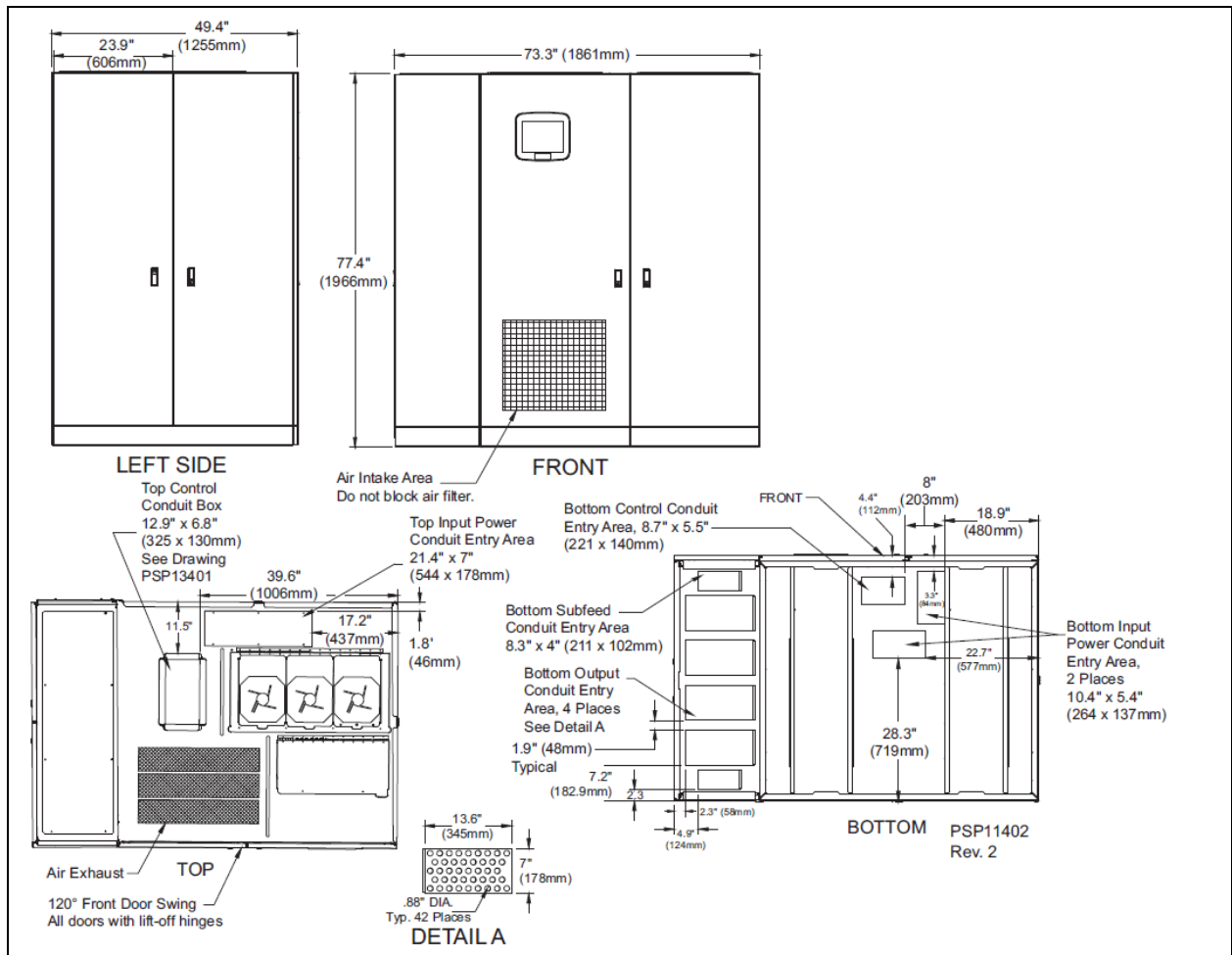

**NOTES TO FIGURE :**

1. Approximate weight:
  - 400A - 4608 lb. (2095kg)
  - 600A - 5692 lb. (2587kg).
2. 18" (457mm) clearance above unit required for air exhaust.
3. Installation and service access required in front and left side only.
4. Keep cabinet within 15 degrees of vertical.
5. Color - IBM off-white.
6. Approximate heat output:
  - 400A - 19,295 BTU/hr (5.66 kW)
  - 600A - 29,238 BTU/hr (8.57 kW).
7. Unit bottom is structurally adequate for forklift handling.
8. Open doors to replace air filter. Disposable type size 1 x 25 x 25 (25 x 635 x 635mm).
9. Top and bottom cable entry available through removable access plates. Remove, punch to suit conduit size and replace.

Figure 8.9 Outline Drawing, 400-600A Vertiv™ Liebert® STS2 / PDU with Left Side Output Breaker or I-Line

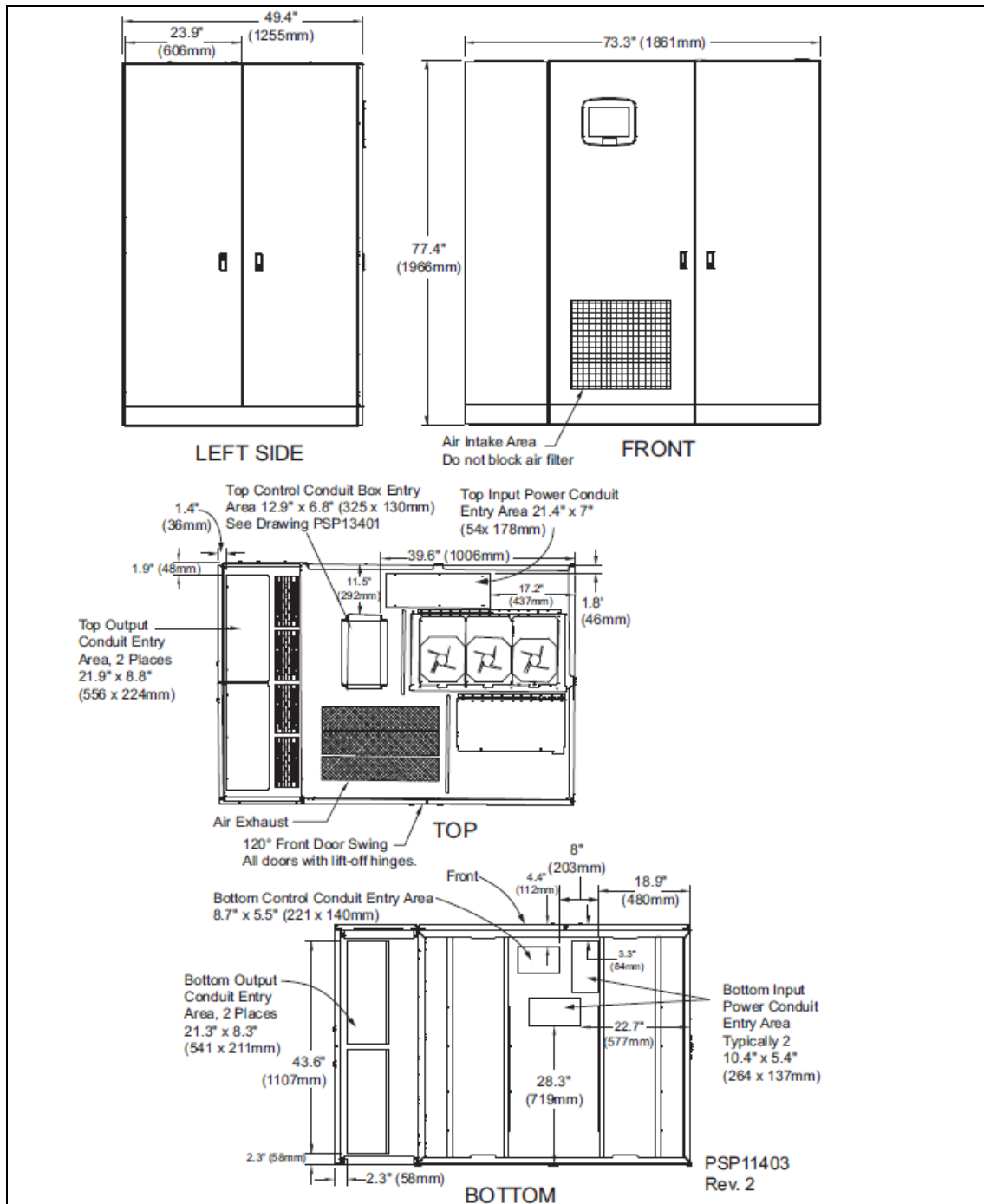

## NOTES TO FIGURE :

1. Approximate weight:
  - 400A - 4608 lb. (2095kg)
  - 600A - 5692 lb. (2587kg).
2. 18" (457mm) clearance above unit required for air exhaust.
3. Installation and service access required in front and left side only.
4. Keep cabinet within 15 degrees of vertical.

5. Color - IBM off-white.
6. Approximate heat output:
  - 400A - 19,295 BTU/hr (5.66 kW)
  - 600A - 29,238 BTU/hr (8.57 kW).
7. Unit bottom is structurally adequate for forklift handling.
8. Open doors to replace air filter. Disposable type, size 1 x 25 x 25 (25 x 635 x 635mm).
9. Top and bottom cable entry available through removable access plates. Remove, punch to suit conduit size and replace.

**Figure 8.10 Outline Drawing, 800A Vertiv™ Liebert® STS2 / PDU with Right Side Output Breaker or I-Line Distribution**

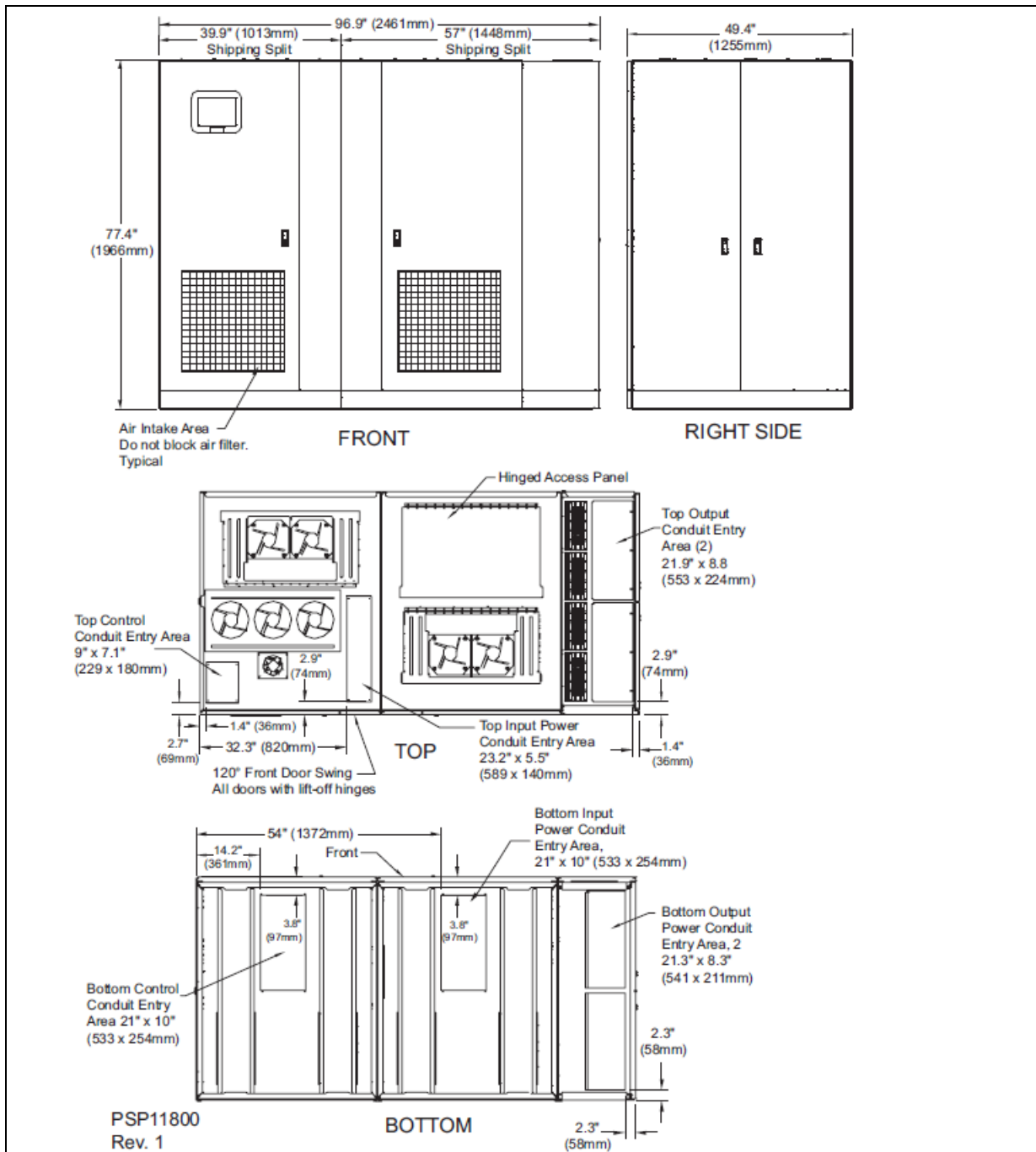



**NOTES TO FIGURE :**

1. Approximate weight: 8618 lb. (3917kg)
2. 18" (457mm) clearance above unit required for air exhaust.
3. Installation and service access required in front and right side only.
4. Keep cabinet within 15 degrees of vertical.
5. Color - IBM off-white.
6. Approximate heat output: 39,238 BTU/hr (11.5 kW)
7. Unit bottom is structurally adequate for forklift handling.
8. Open doors to replace air filter. Disposable type size 1 x 25 x 25 (25 x 635 x 635mm).
9. Top and bottom cable entry available through removable access plates. Remove, punch to suit conduit size and replace.



Figure 8.11 Outline Drawing, 800A Vertiv™ Liebert® STS2 / PDU with Right Side Inline Distribution

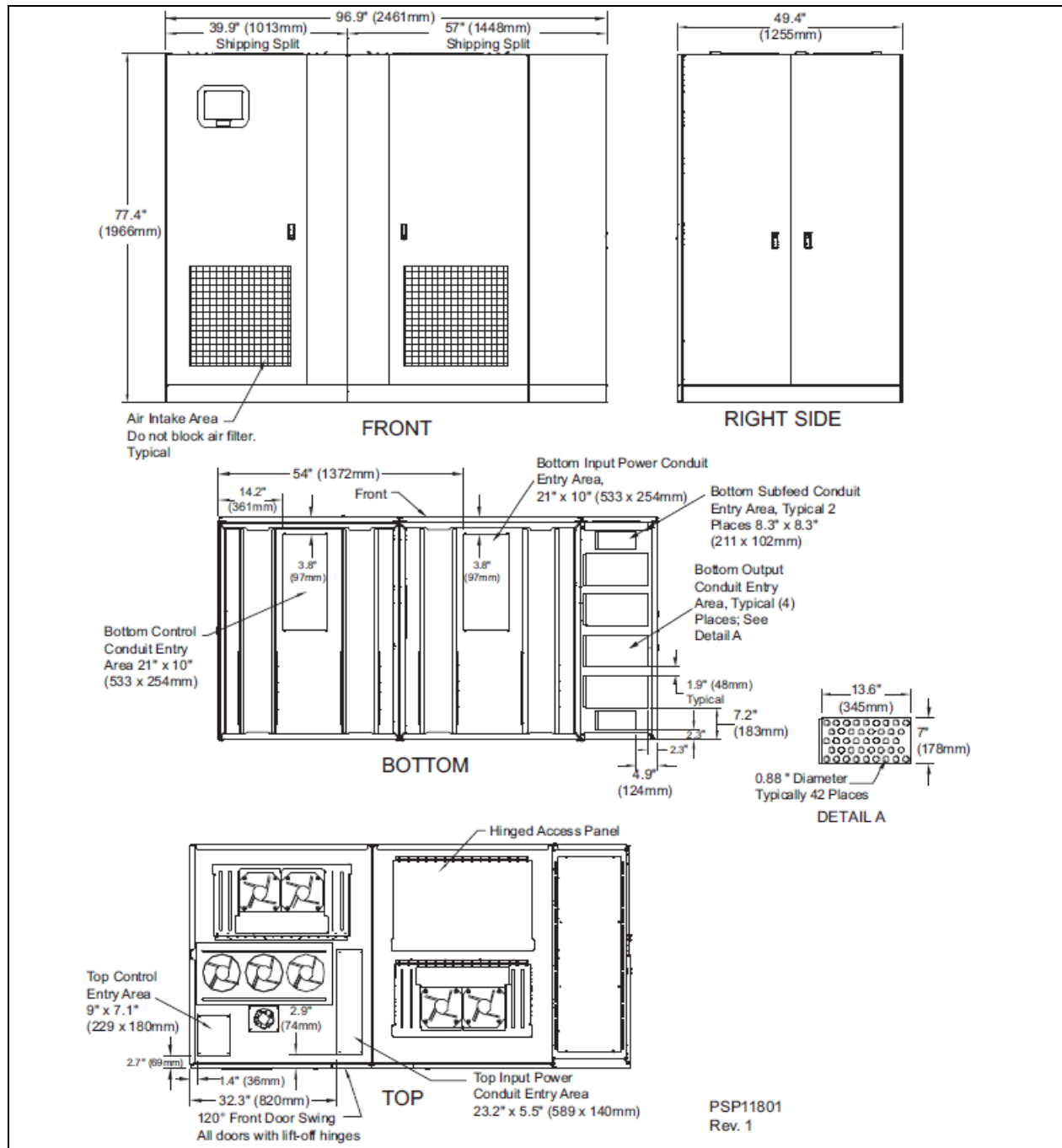

## NOTES TO FIGURE :

1. Approximate weight: 8618 lb. (3917kg)
2. 18" (457mm) clearance above unit required for air exhaust.
3. Installation and service access required in front and right side only.
4. Keep cabinet within 15 degrees of vertical.
5. Color - IBM off-white.
6. Approximate heat output: 39,238 BTU/hr (11.5 kW)

7. Unit bottom is structurally adequate for forklift handling.
8. Open doors to replace air filter. Disposable type size 1 x 25 x 25 (25 x 635 x 635mm).
9. Top and bottom cable entry available through removable access plates. Remove, punch to suit conduit size and replace.

**Figure 8.12 Outline Drawing, 800A Vertiv™ Liebert® STS2 / PDU with Left Side Output Breaker or I-Line Distribution**

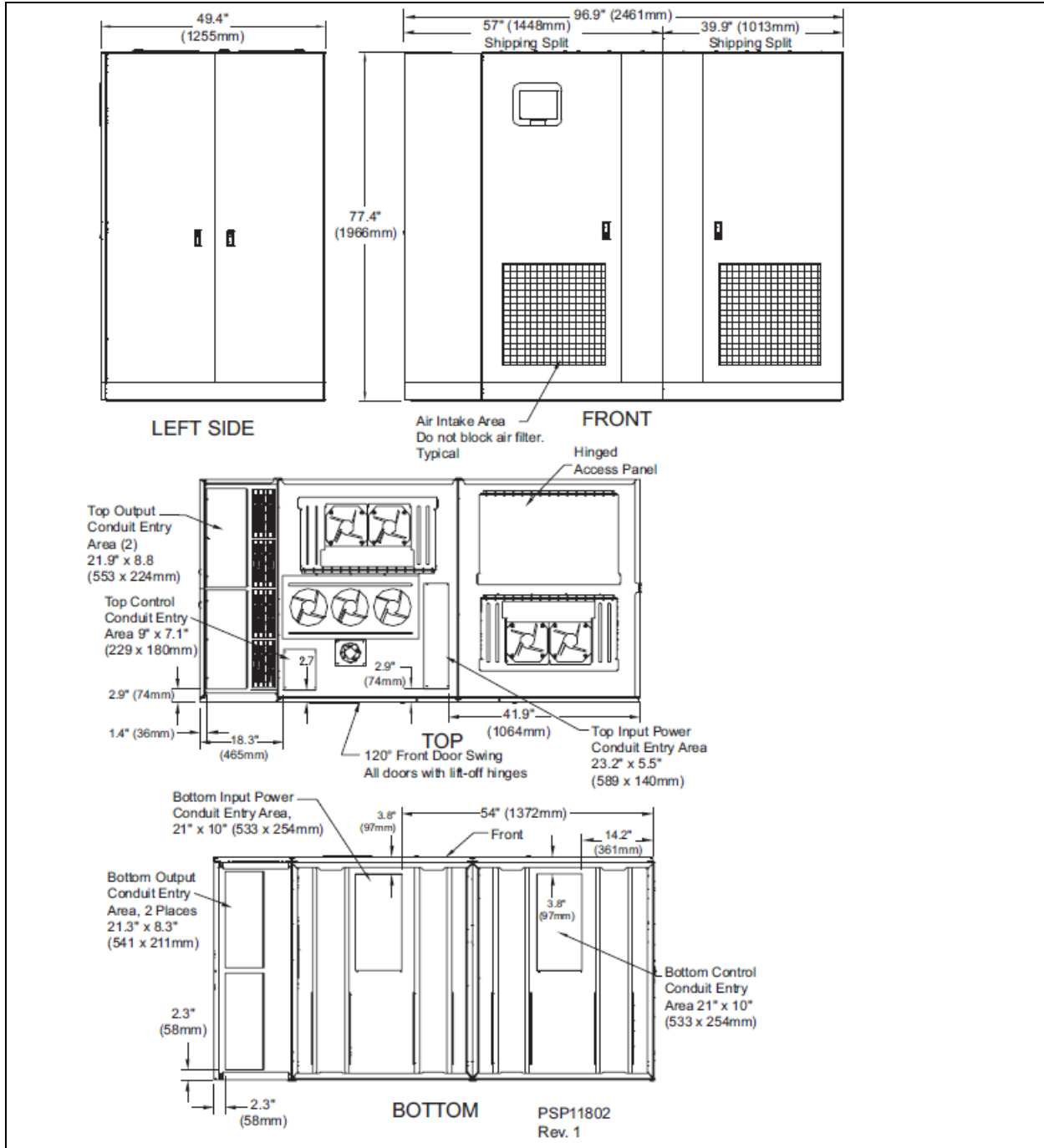

**NOTES TO FIGURE :**

1. Approximate weight: 8618 lb. (3917kg)
2. 18" (457mm) clearance above unit required for air exhaust.
3. Installation and service access required in front and left side only.
4. Keep cabinet within 15 degrees of vertical.
5. Color - IBM off-white.
6. Approximate heat output: 39,238 BTU/hr (11.5 kW)
7. Unit bottom is structurally adequate for forklift handling.
8. Open doors to replace air filter. Disposable type size 1 x 25 x 25 (25 x 635 x 635mm).
9. Top and bottom cable entry available through removable access plates. Remove, punch to suit conduit size and replace.

Figure 8.13 Outline Drawing, 800A Vertiv™ Liebert® STS2 / PDU with Left Side Inline Distribution

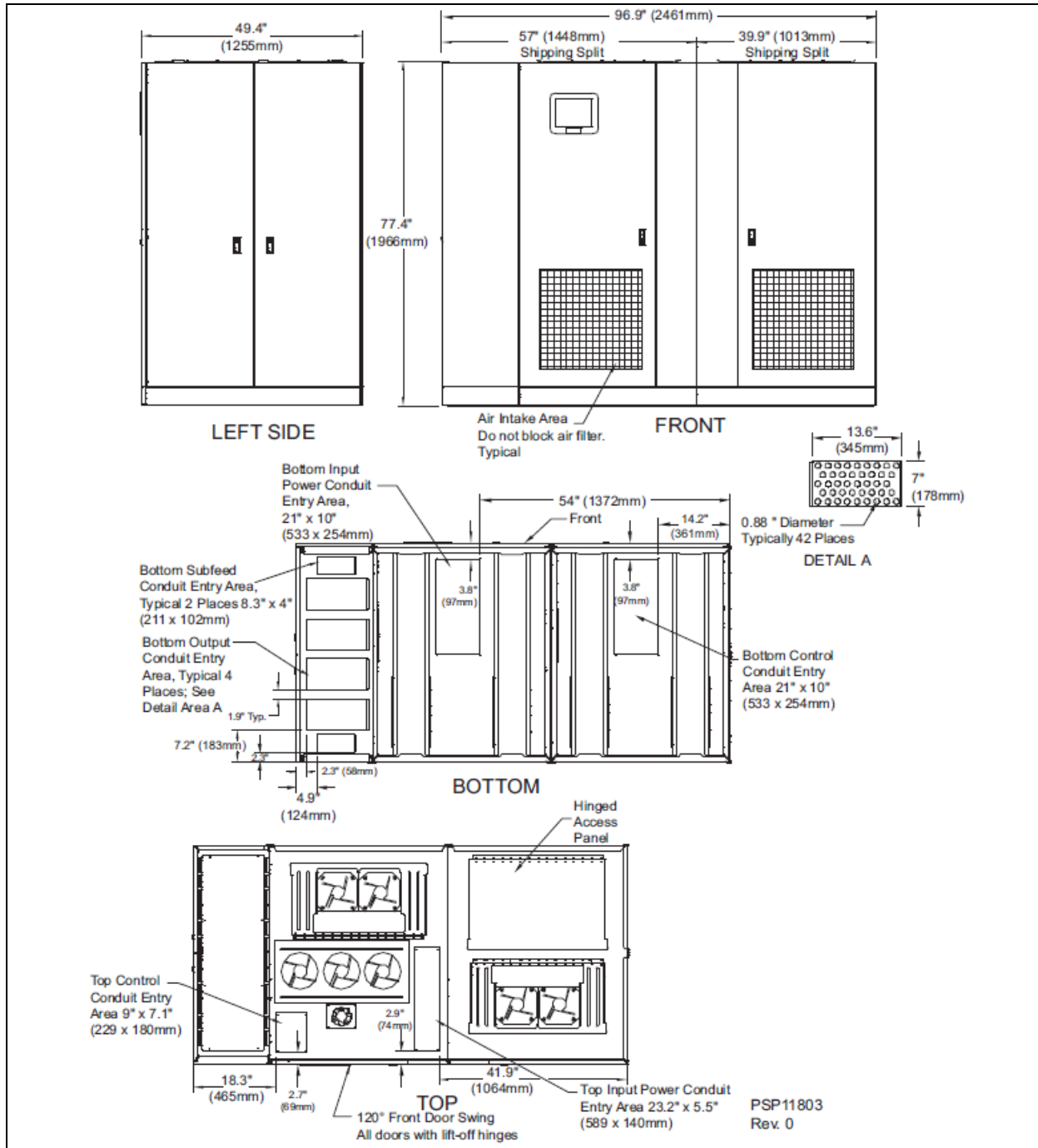

NOTES TO FIGURE:

1. Approximate weight: 8618 lb. (3917kg)
2. 18" (457mm) clearance above unit required for air exhaust.
3. Installation and service access required in front and left side only.
4. Keep cabinet within 15 degrees of vertical.
5. Color - IBM off-white.
6. Approximate heat output: 39,238 BTU/hr (11.5 kW)

7. Unit bottom is structurally adequate for forklift handling.
8. Open doors to replace air filter. Disposable type size 1 x 25 x 25 (25 x 635 x 635mm).
9. Top and bottom cable entry available through removable access plates. Remove, punch to suit conduit size and replace.

Figure 8.14 Outline Drawing, 250A Vertiv™ Liebert® STS2 / PDU with Key Lockout Switch Option

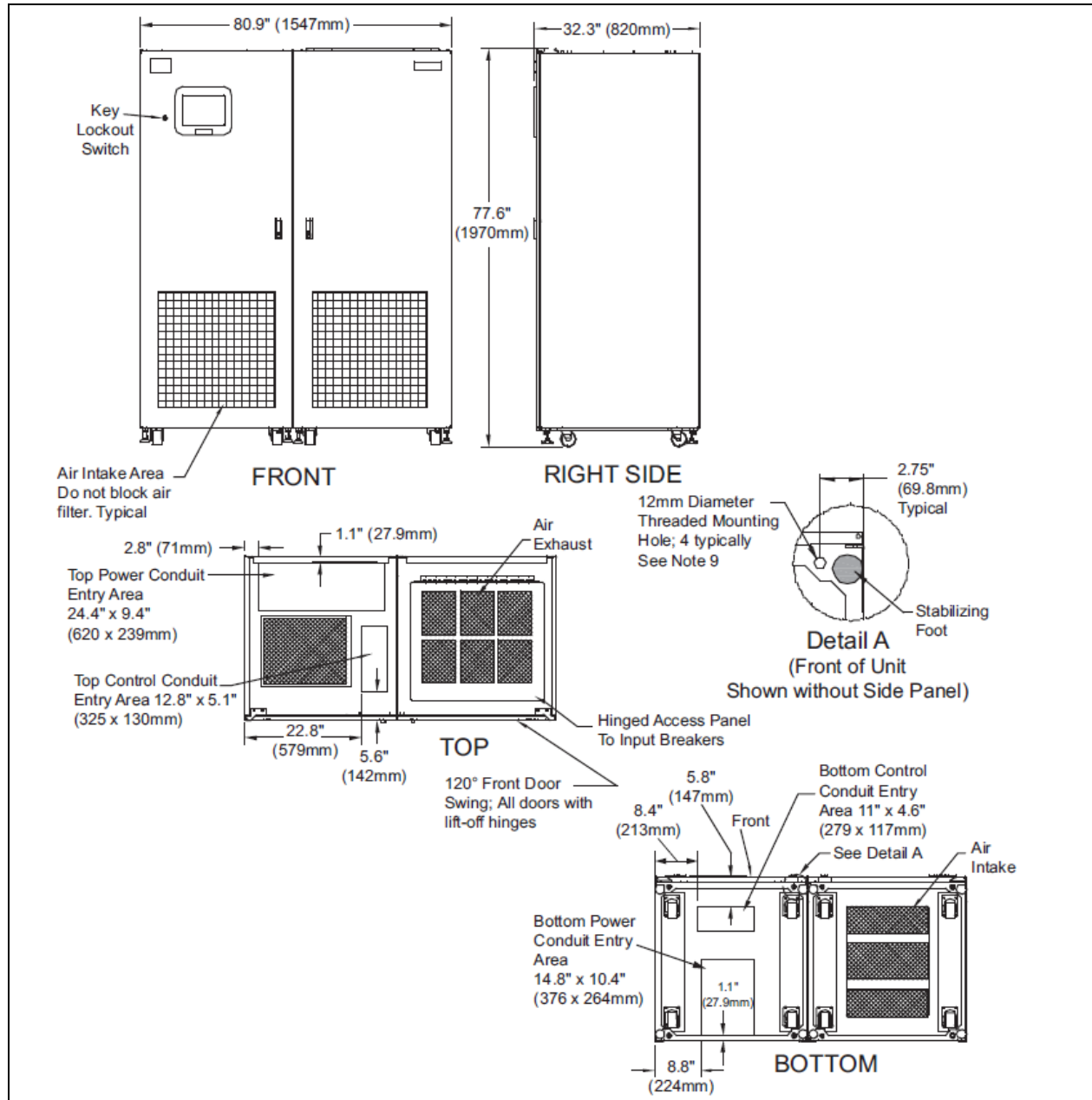

**NOTES TO FIGURE:**

1. 18" (457mm) clearance above unit required for air exhaust.
2. Installation and service access required in front only.
3. Approximate heat output: 11,737 BTU/Hr (3.44 kW).
4. Approximate weight: 3393 lb. (1542 kg).
5. Unit bottom is structurally adequate for forklift handling.
6. Keep cabinet within 15 degrees of vertical.
7. Color: IBM off-white
8. Open door to replace air filter. Disposable type, size, 1" x 25" x 25" (25 x 635 x 635mm).
9. Threaded mounting holes (see Detail A) are provided for seismic anchoring or floor stand. Mounting bolts must be threaded into the unit from underneath the unit base. If a floor stand is used, the casters must rest on the floor stand to support the weight of the unit.
10. Top and bottom cable entry available through removable access plates. Remove, punch to suit conduit size and replace.

Figure 8.15 Outline Drawing, Vertiv™ Liebert® STS2 / PDU, Inline Distribution, Right Side with Key Lockout

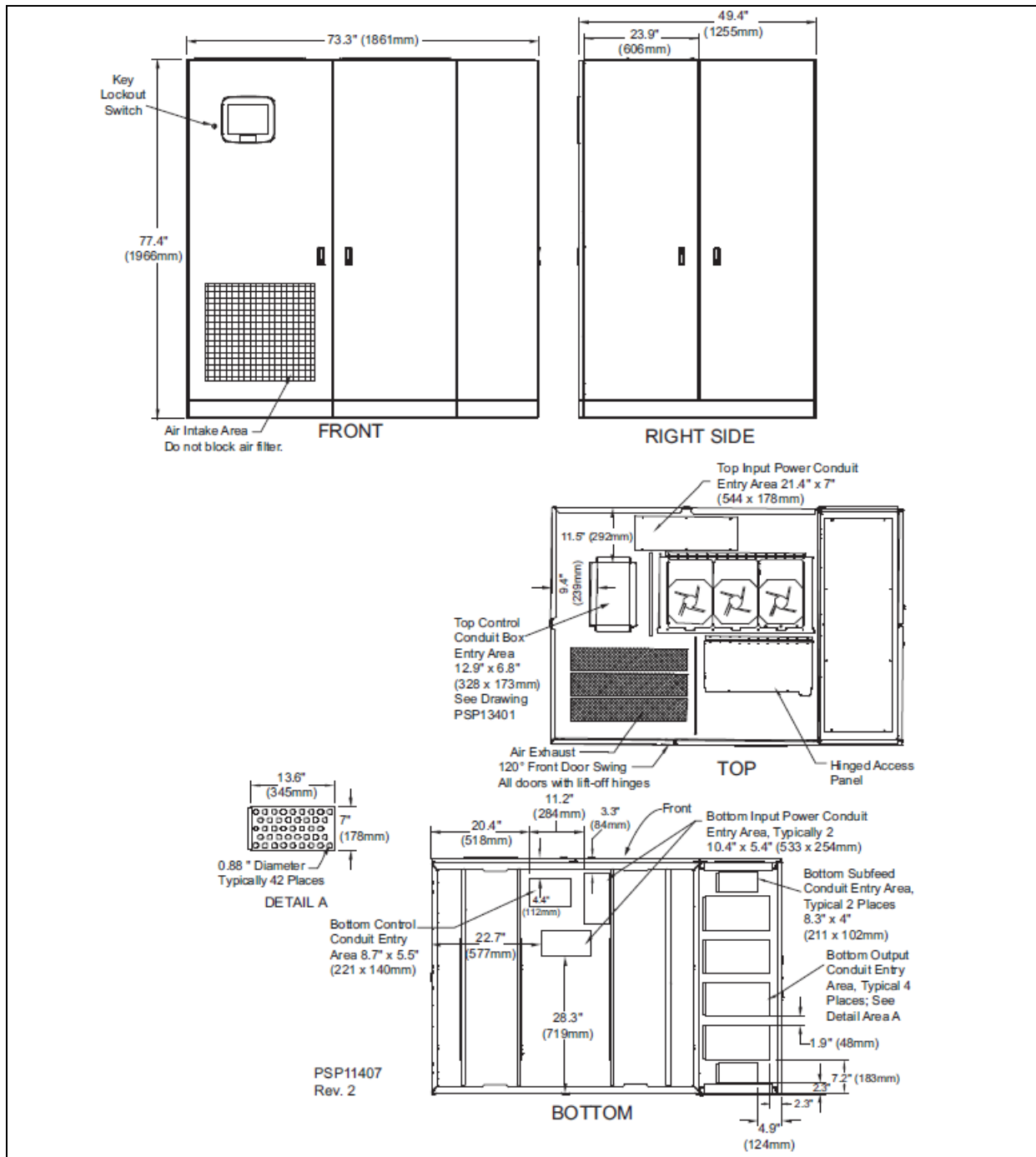

**NOTES TO FIGURE:**

1. Approximate weight:
  - 400A - 4608 lb. (2095kg)
  - 600A - 5692 lb. (2587kg)
2. 18" (457mm) clearance above unit required for air exhaust.
3. Installation and service access required in front and right side only.
4. Keep cabinet within 15 degrees of vertical.
5. Color - IBM off-white.
6. Approximate heat output:
  - 400A - 19,295 BTU/hr (5.66 kW)
  - 600A - 29,238 BTU/hr (8.57 kW)
7. Unit bottom is structurally adequate for forklift handling.
8. Open doors to replace air filter. Disposable type, size 1 x 25 x 25 (25 x 635 x 635mm).
9. Top and bottom cable entry available through removable access plates. Remove, punch to suit conduit size and replace.



Figure 8.16 Outline Drawing, 800A Vertiv™ Liebert® STS2 / PDU, Inline Distribution, Right Side with Key Lockout Switch

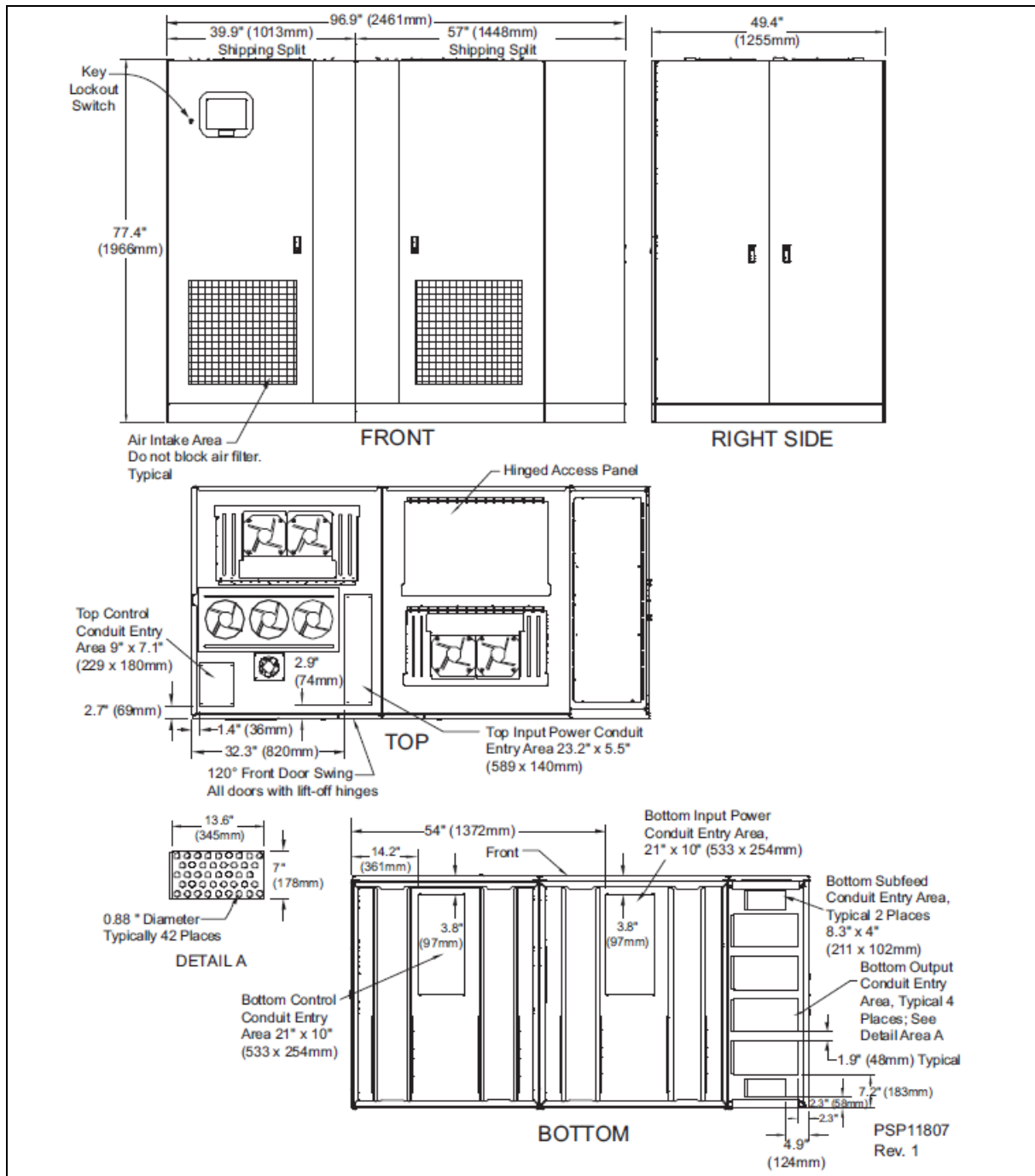

NOTES TO FIGURE:

1. Approximate weight: 8618 lb. (3917kg)
2. 18" (457mm) clearance above unit required for air exhaust.
3. Installation and service access required in front and right side only.
4. Keep cabinet within 15 degrees of vertical.
5. Color - IBM off-white.

6. Approximate heat output: 39,238 BTU/hr (11.5 kW)
7. Unit bottom is structurally adequate for forklift handling.
8. Open doors to replace air filter. Disposable type, size 1 x 25 x 25 (25 x 635 x 635mm).
9. Top and bottom cable entry available through removable access plates. Remove, punch to suit conduit size and replace.

**Figure 8.17 Electrical Field Connections, 250A Vertiv™ Liebert® STS2 / PDU Input/Output with CB8**

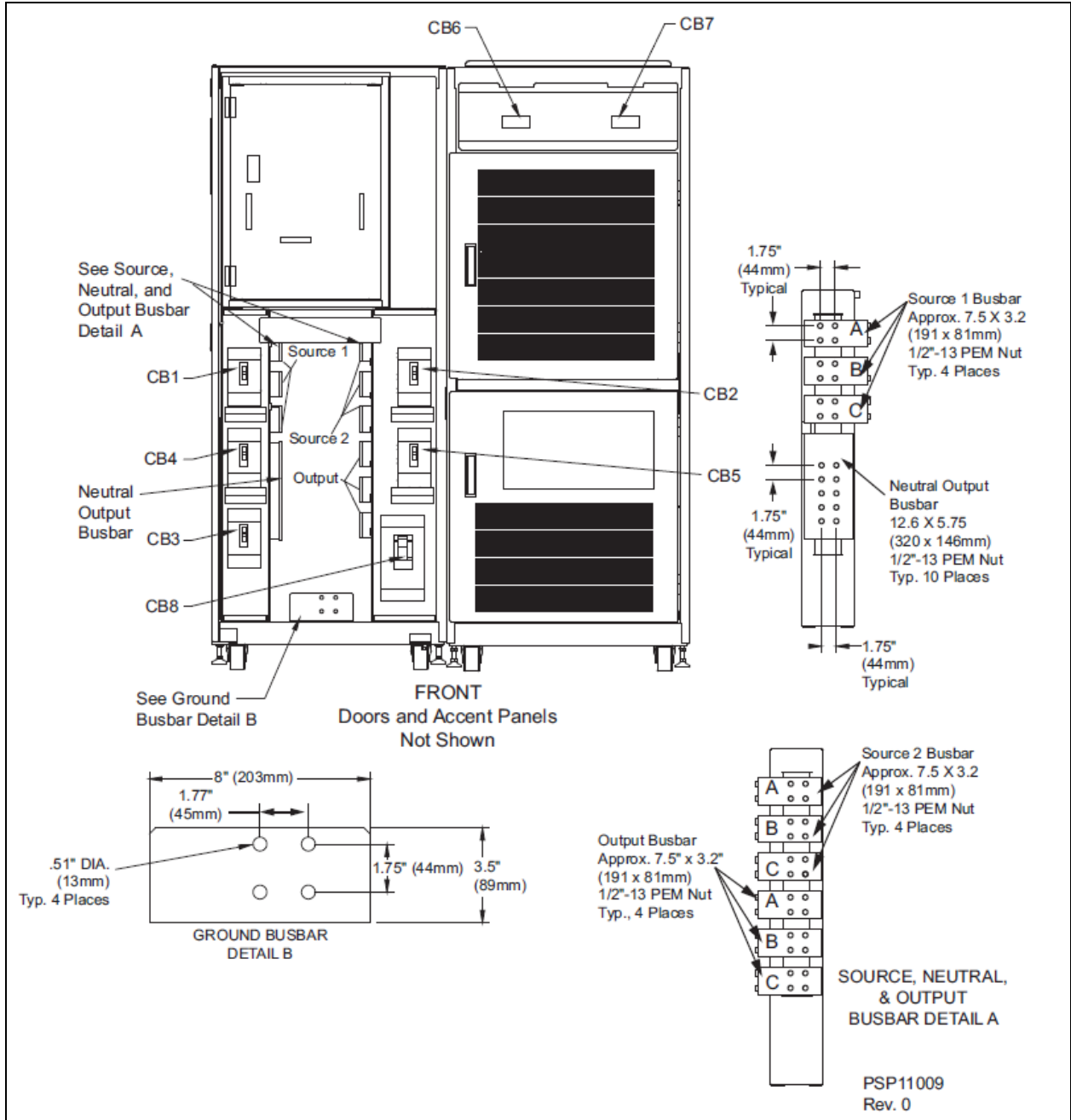

NOTES TO FIGURE:

1. Phase, neutral and ground busbars are 1/4" thick.
2. Control wiring and power wiring must be run in separate conduit. Output cables should be run in a separate conduit from input cables.
3. Aluminum and copper clad aluminum cables are not recommended.
4. All wiring is to be in accordance with national and local electrical codes

Figure 8.18 Electrical Field Connections, 250A Vertiv™ Liebert® STS2 / PDU Input with CB3

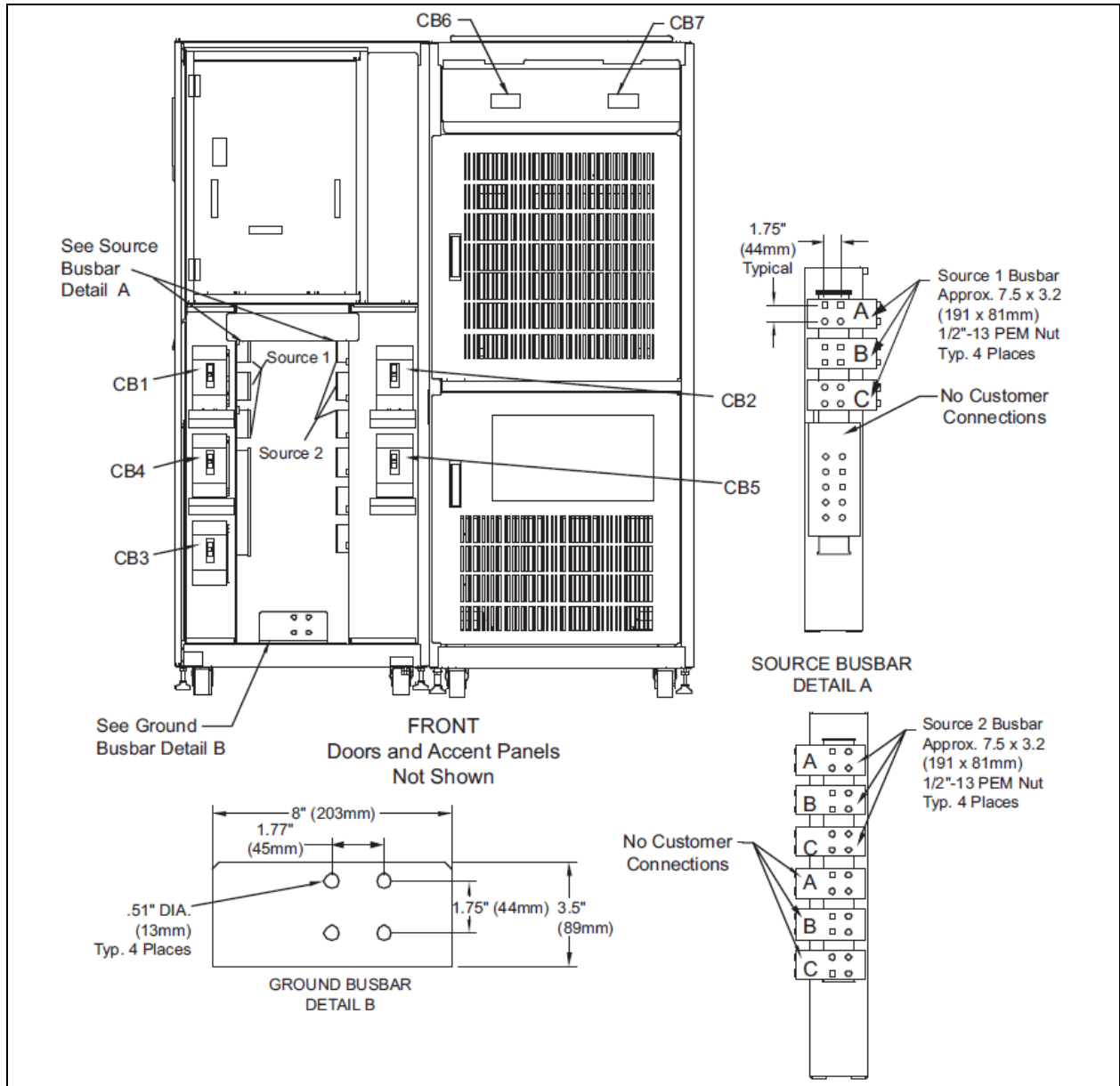

NOTES TO FIGURE:

1. Phase, neutral and ground busbars are 1/4" thick.
2. Control wiring and power wiring must be run in separate conduit. Output cables should be run in a separate conduit from input cables.

3. Aluminum and copper clad aluminum cables are not recommended.
4. All wiring is to be in accordance with national and local electrical codes.

**Figure 8.19 Electrical Field Connections, 250A Vertiv™ Liebert® STS2 / PDU Input with CB3 & CB3A**

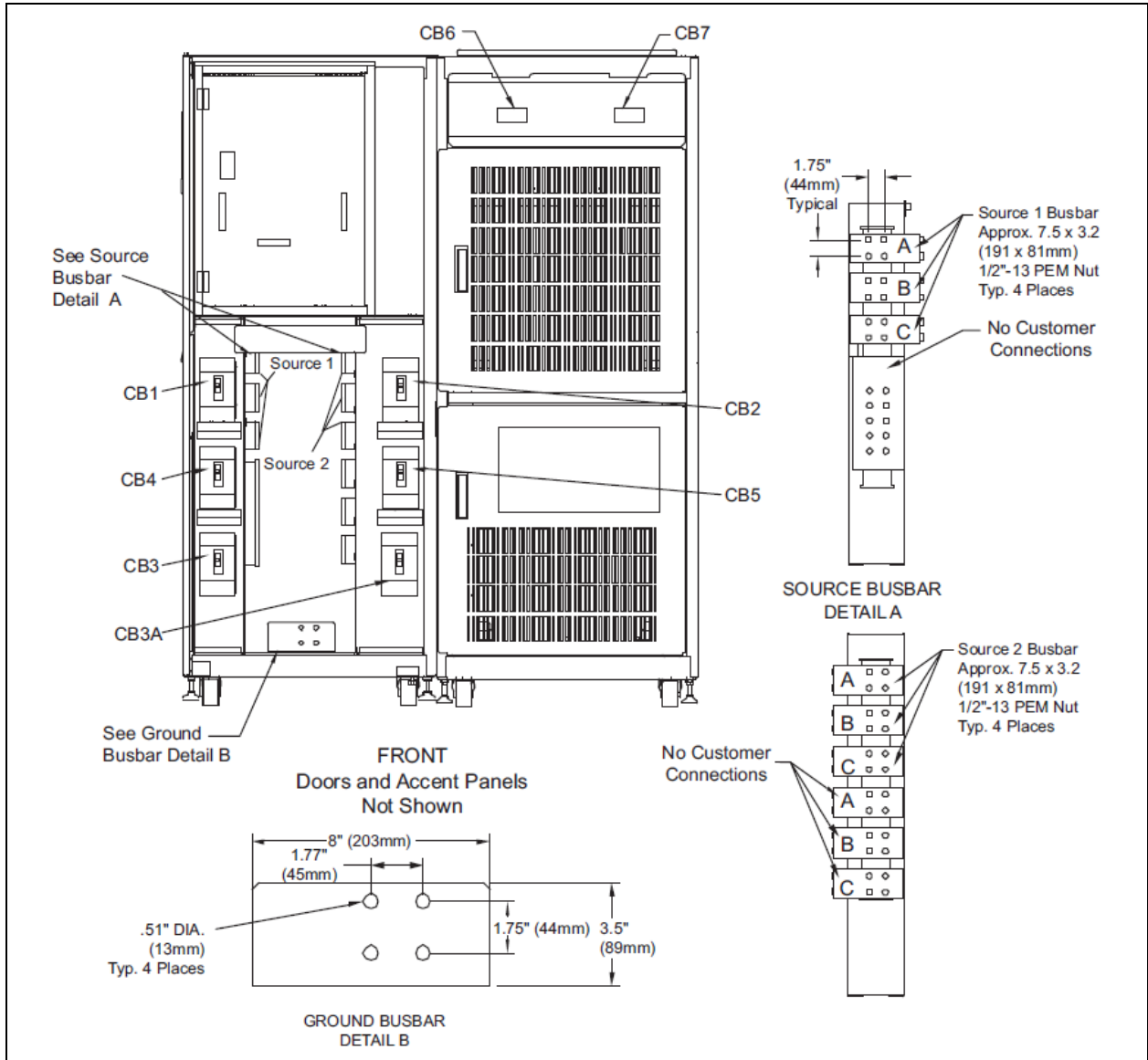

**NOTES TO FIGURE:**

1. Phase, neutral and ground busbars are 1/4" thick.
2. Control wiring and power wiring must be run in separate conduit. Output cables should be run in a separate conduit from input cables.
3. Aluminum and copper clad aluminum cables are not recommended.
4. All wiring is to be in accordance with national and local electrical codes

Figure 8.20 Electrical Field Connections, 400-600A Vertiv™ Liebert® STS2 / PDU Input with CB3

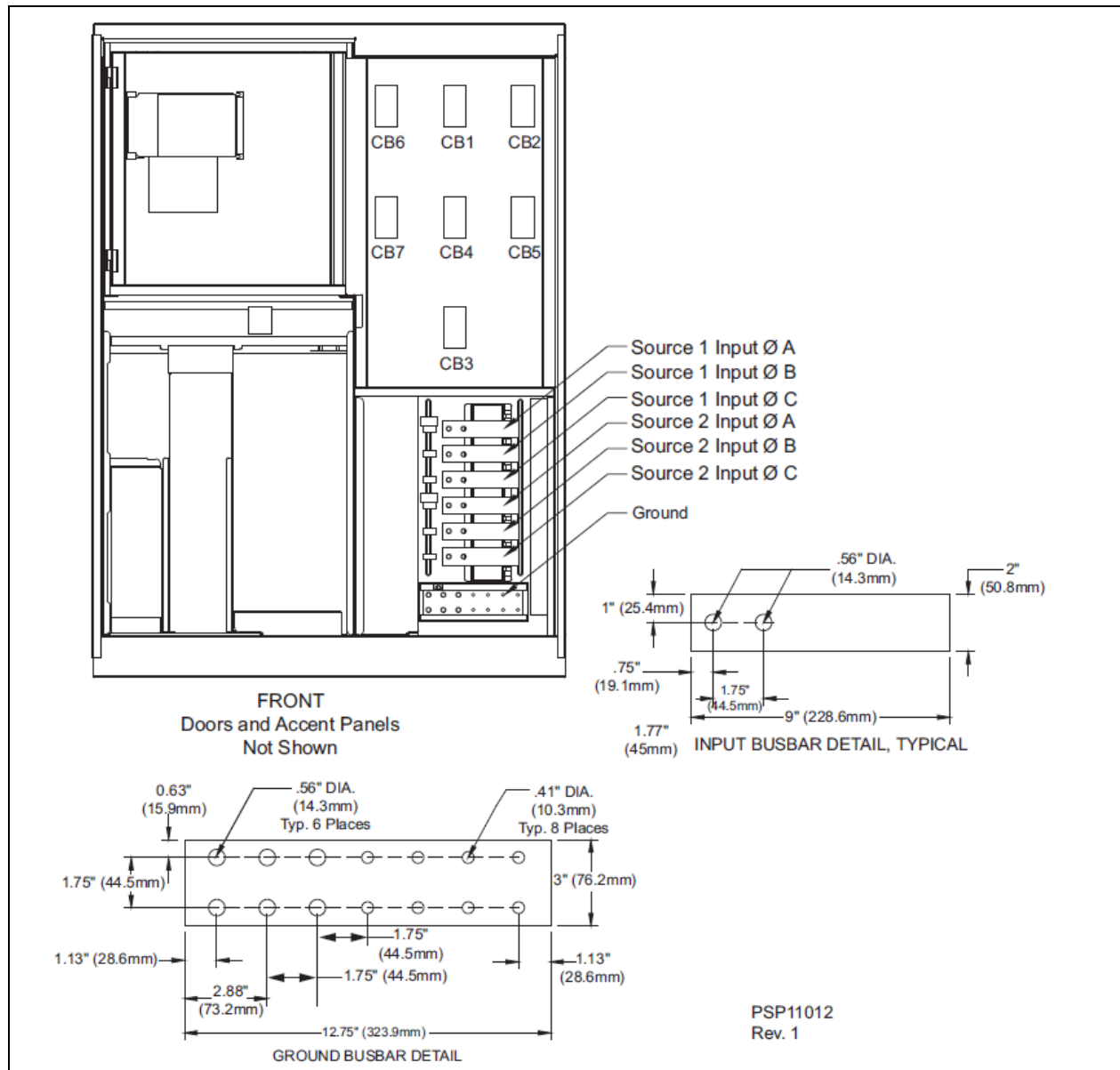

## NOTES TO FIGURE :

1. Phase, neutral and ground busbars are 1/4" thick.
2. Control wiring and power wiring must be run in separate conduit. Output cables should be run in a separate conduit from input cables.
3. Aluminum and copper clad aluminum cables are not recommended.
4. All wiring is to be in accordance with national and local electrical codes.

Figure 8.21 Electrical Field Connections, 400-600A Vertiv™ Liebert® STS2 / PDU Input with CB3 and CB3A

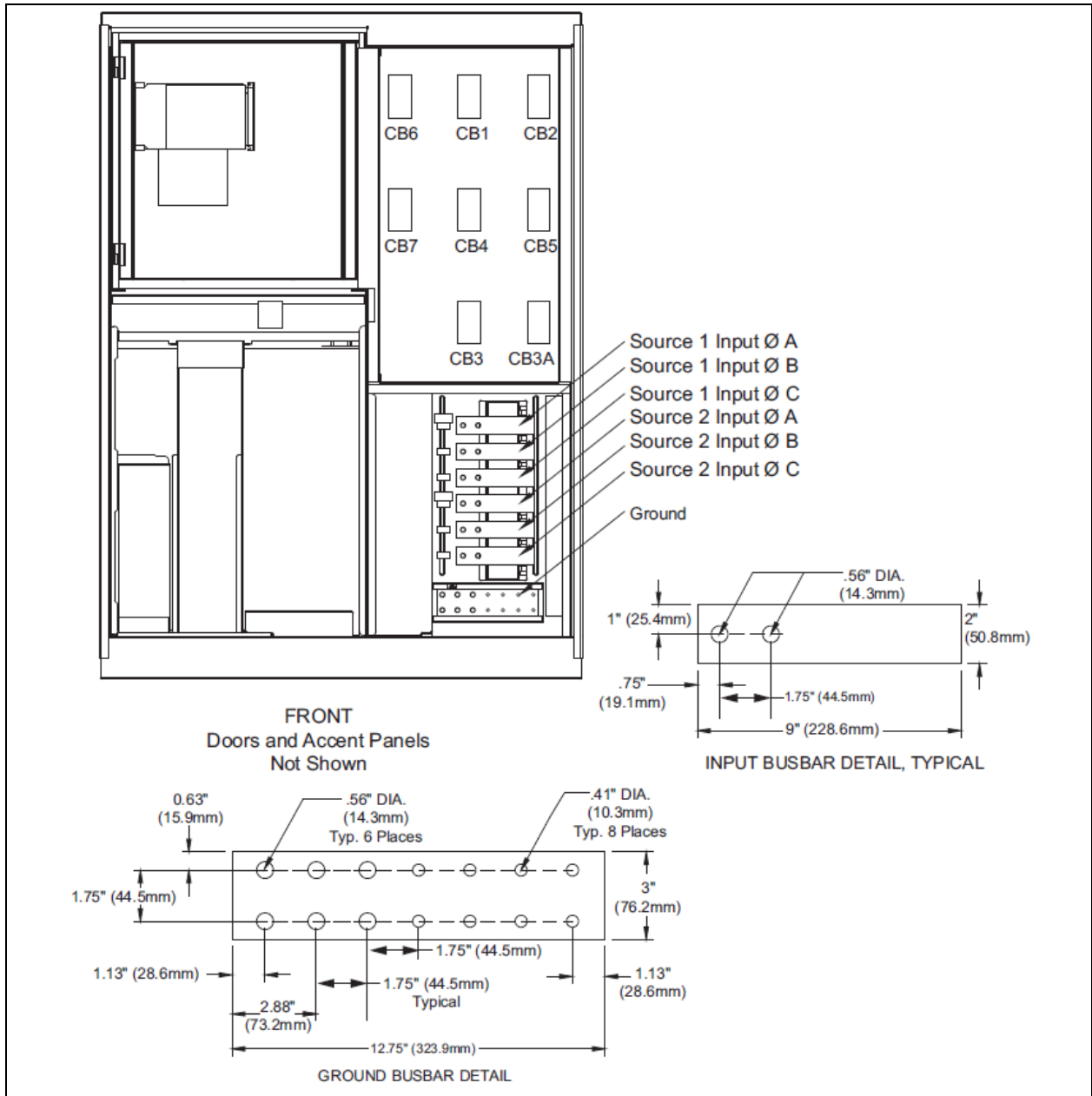

NOTES TO FIGURE:

1. Phase, neutral and ground busbars are 1/4" thick.
2. Control wiring and power wiring must be run in separate conduit. Output cables should be run in a separate conduit from input cables.
3. Aluminum and copper clad aluminum cables are not recommended.
4. All wiring is to be in accordance with national and local electrical codes.

Figure 8.22 Electrical Field Connections, 800A Vertiv™ Liebert® STS2 / PDU Input with CB3 and CB3A

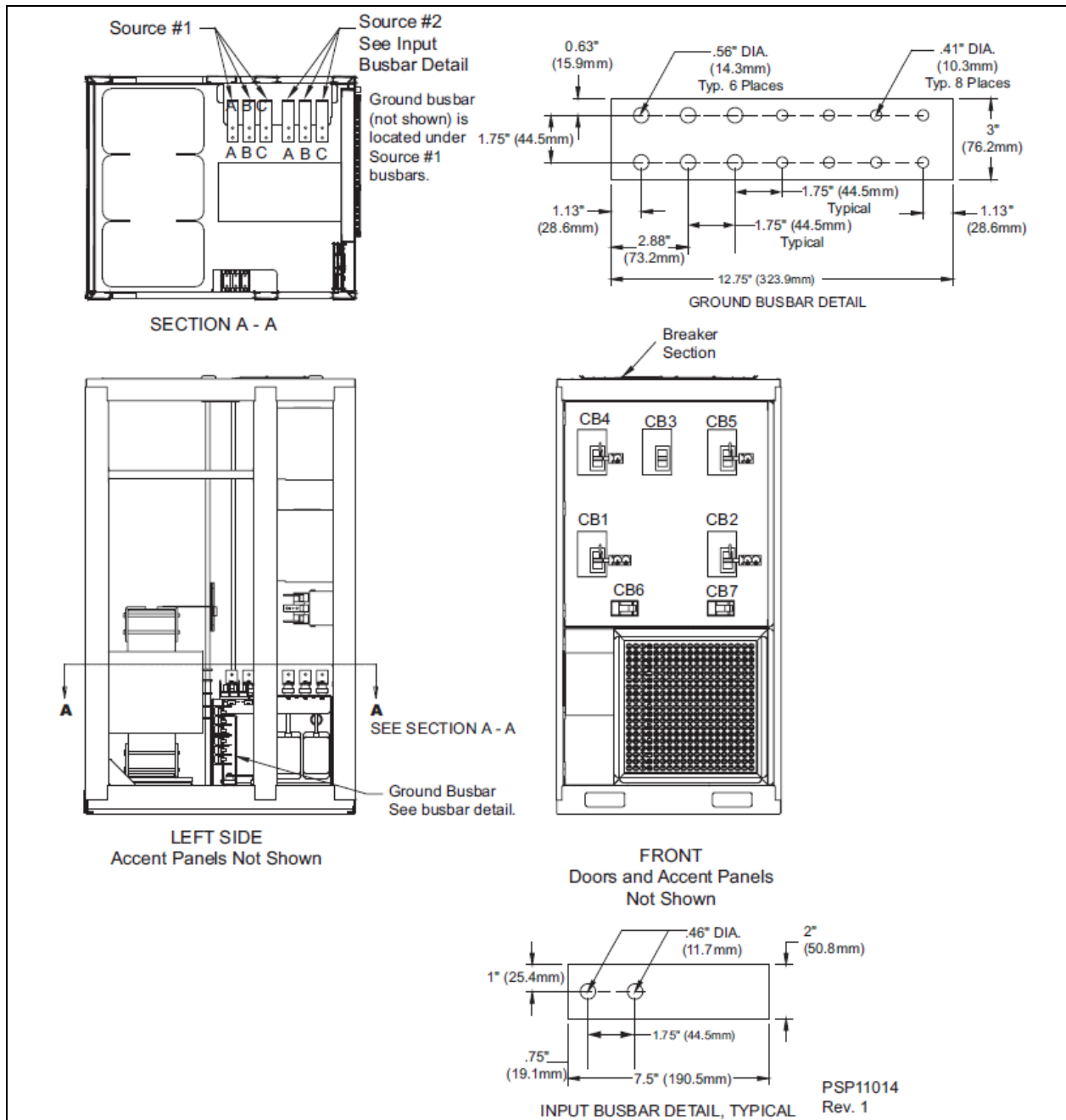

## NOTES TO FIGURE:

1. Phase, neutral and ground busbars are 1/4" thick.
2. Control wiring and power wiring must be run in separate conduit. Output cables should be run in a separate conduit from input cables.
3. Aluminum and copper clad aluminum cables are not recommended.
4. All wiring is to be in accordance with national and local electrical codes.

Figure 8.23 Electrical Field Connections, 800A Vertiv™ Liebert® STS2 / PDU Input with CB3 and CB3A

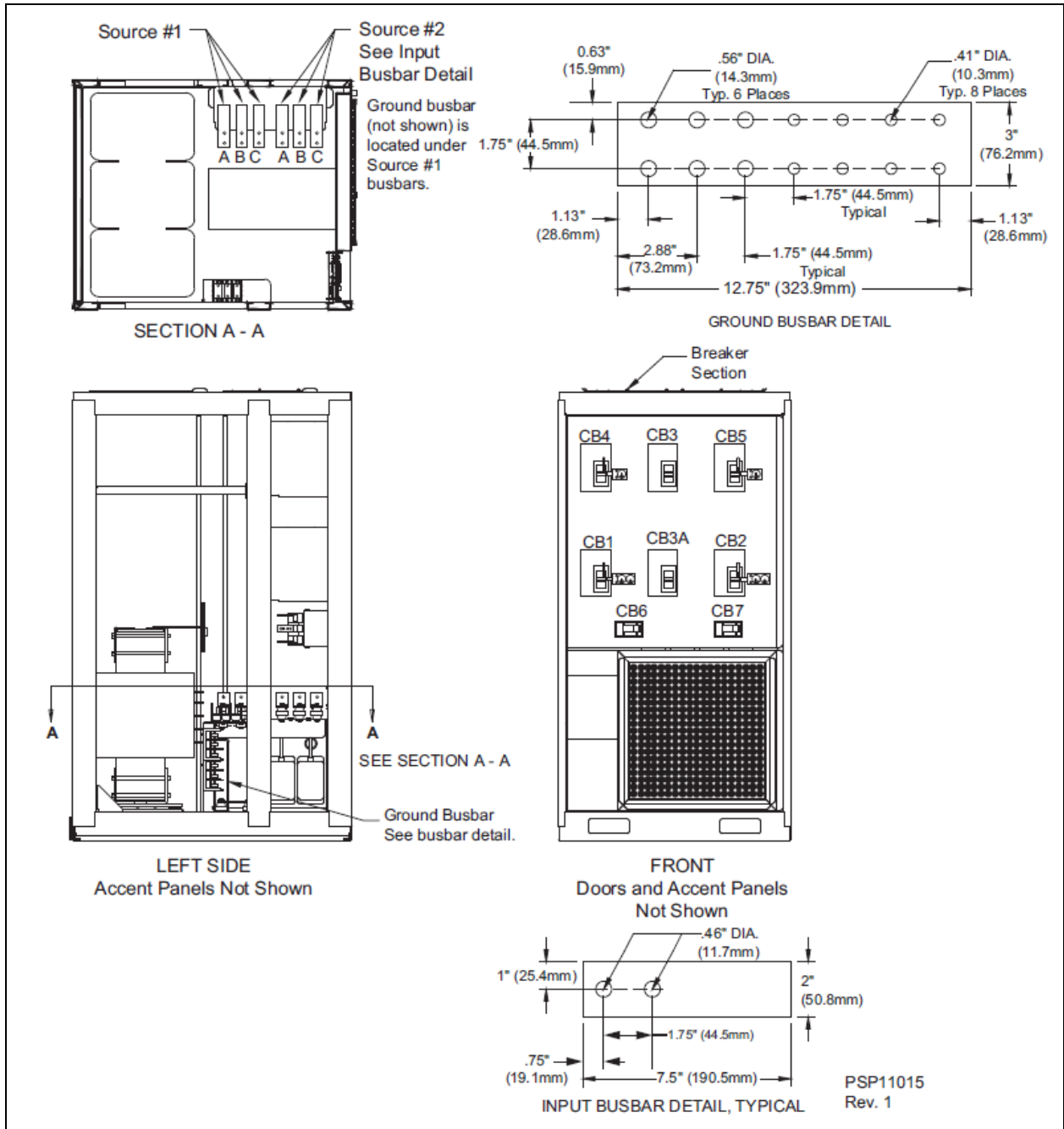

NOTES TO FIGURE:

1. Phase, neutral and ground busbars are 1/4" thick.
2. Control wiring and power wiring must be run in separate conduit. Output cables should be run in a separate conduit from input cables.
3. Aluminum and copper clad aluminum cables are not recommended.
4. All wiring is to be in accordance with national and local electrical codes



Figure 8.24 Electrical Field Connections, 250A Vertiv™ Liebert® STS2 / PDU Output with Inline Panelboards

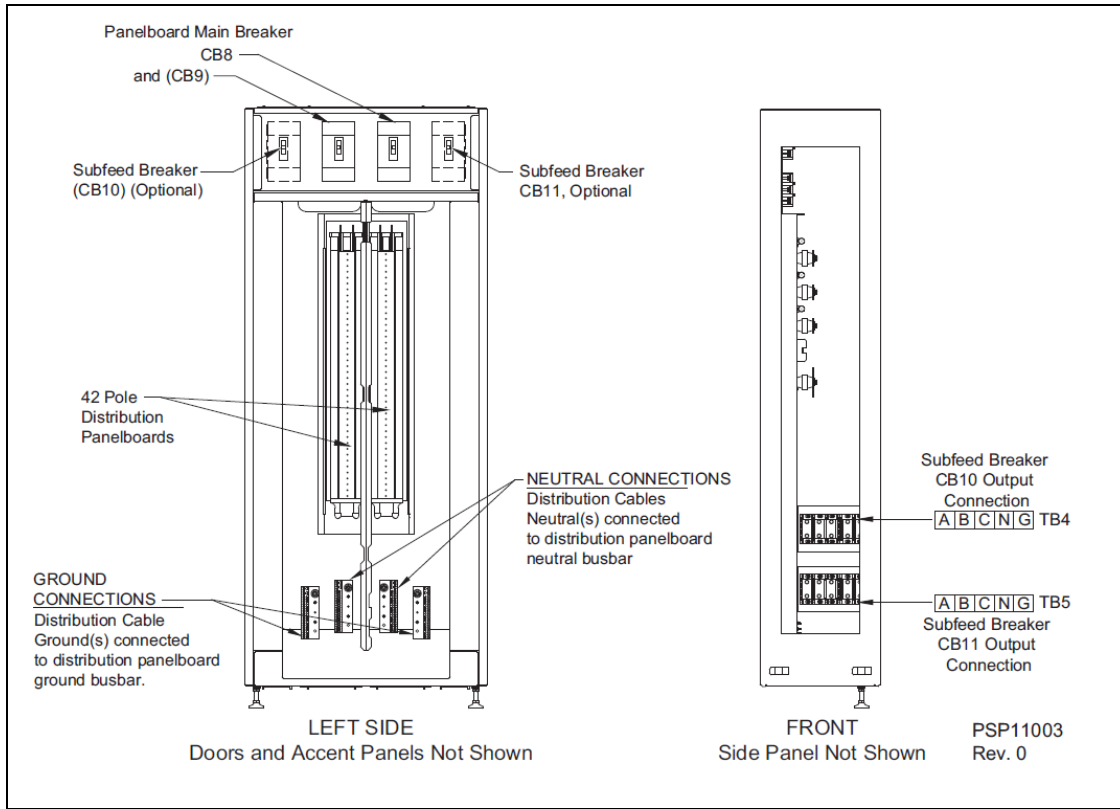

Figure 8.25 Electrical Field Connections, 400-800A Liebert® STS2 / PDU Output with Inline Panelboards

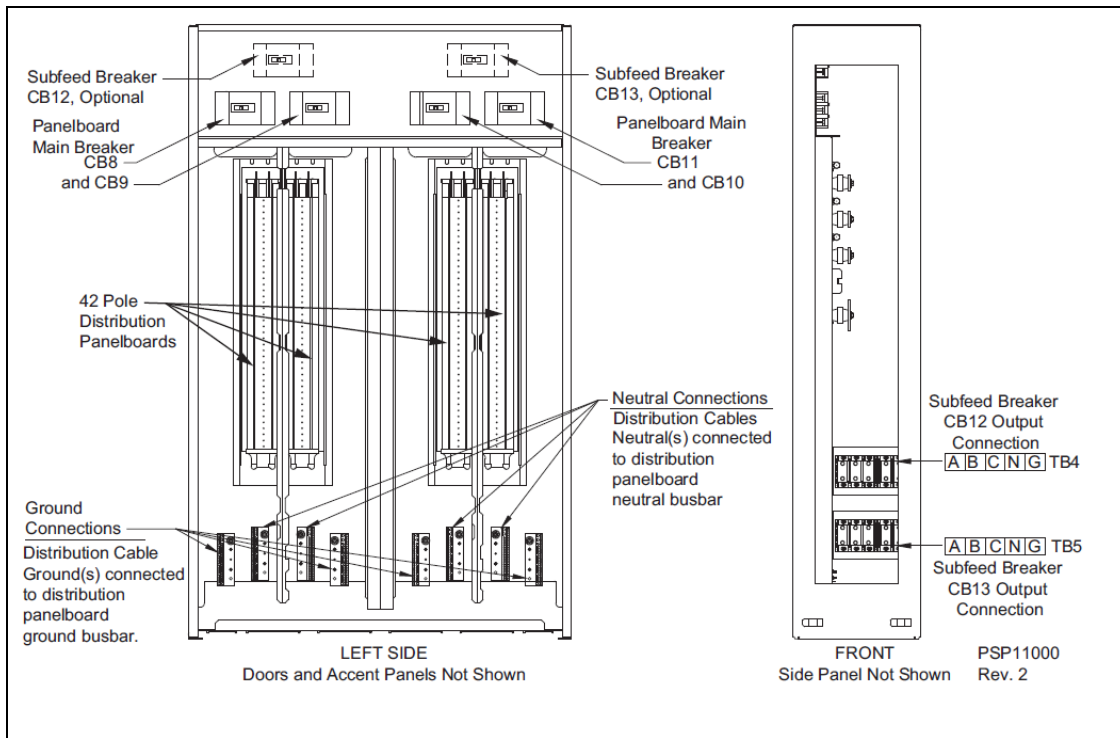

Figure 8.26 Electrical Field Connections, Vertiv™ Liebert® STS2 / PDU Output with I-Line Panelboard

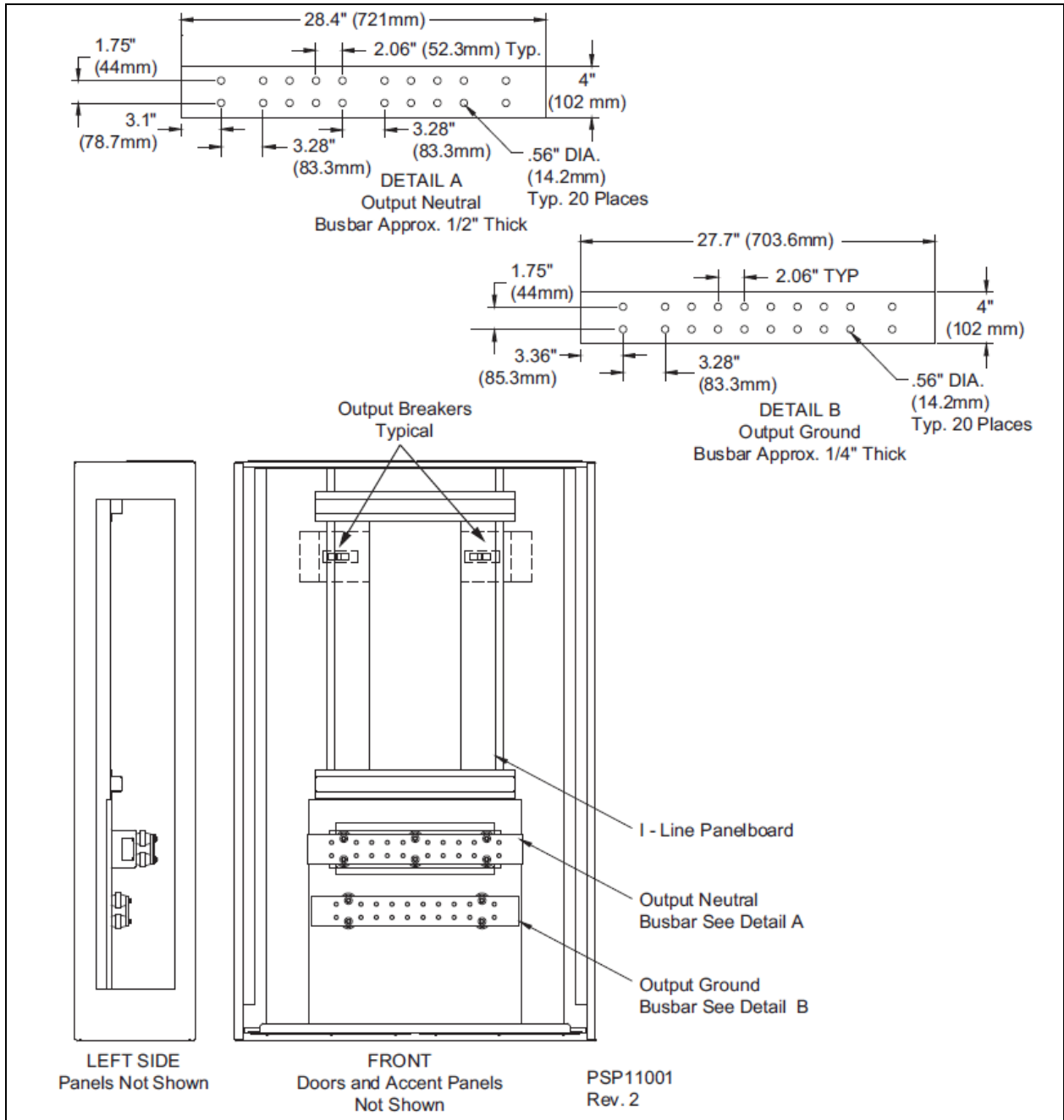

Figure 8.27 Electrical Field Connections, 400-600A Vertiv™ Liebert® STS2 / PDU with Right Side Output Breaker

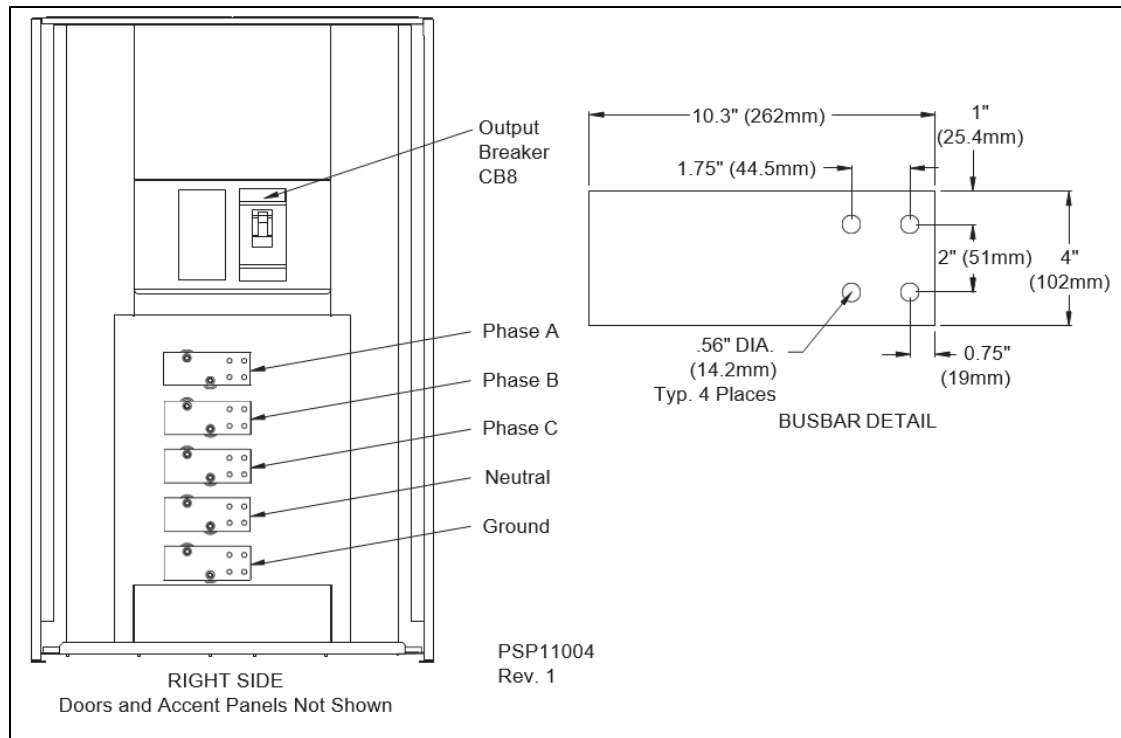

Figure 8.28 Electrical Field Connections, 400-600A Liebert® STS2 / PDU with Left Side Output Breaker

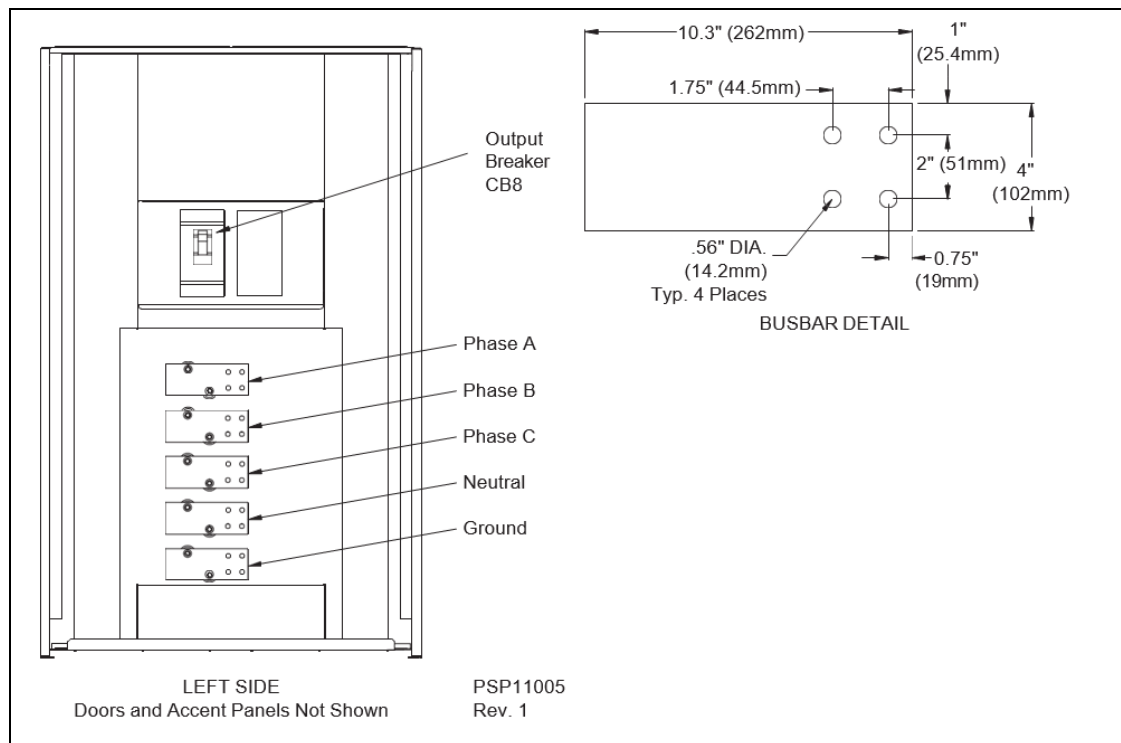
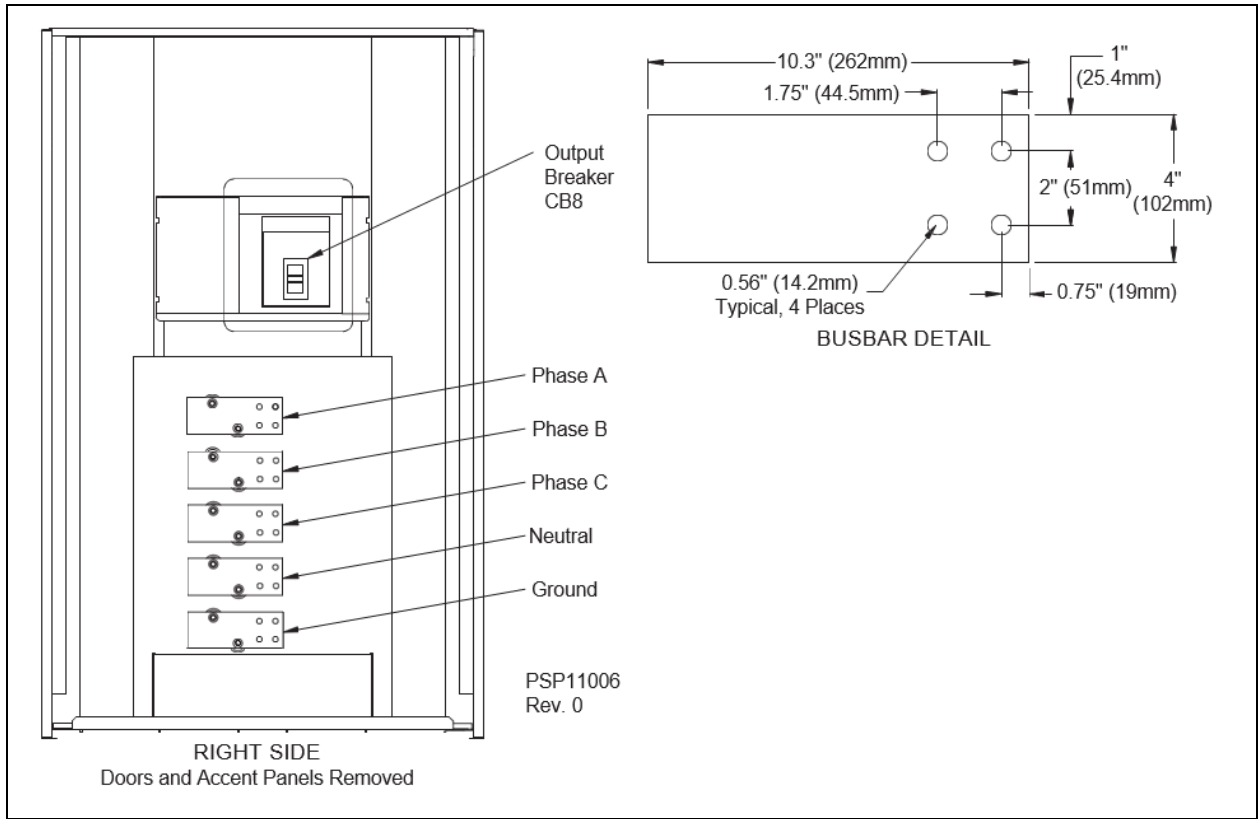

Figure 8.29 Electrical Field Connections, 800A Vertiv™ Liebert® STS2 / PDU with Right Side Output Breaker



NOTS TO FIGURE:

1. Phase and ground busbars are 1/4" thick.
2. Neutral busbar is 1/2" thick.

Figure 8.30 Electrical Field Connections, 8600A Vertiv™ Liebert® STS2 / PDU with Left Side Output Breaker

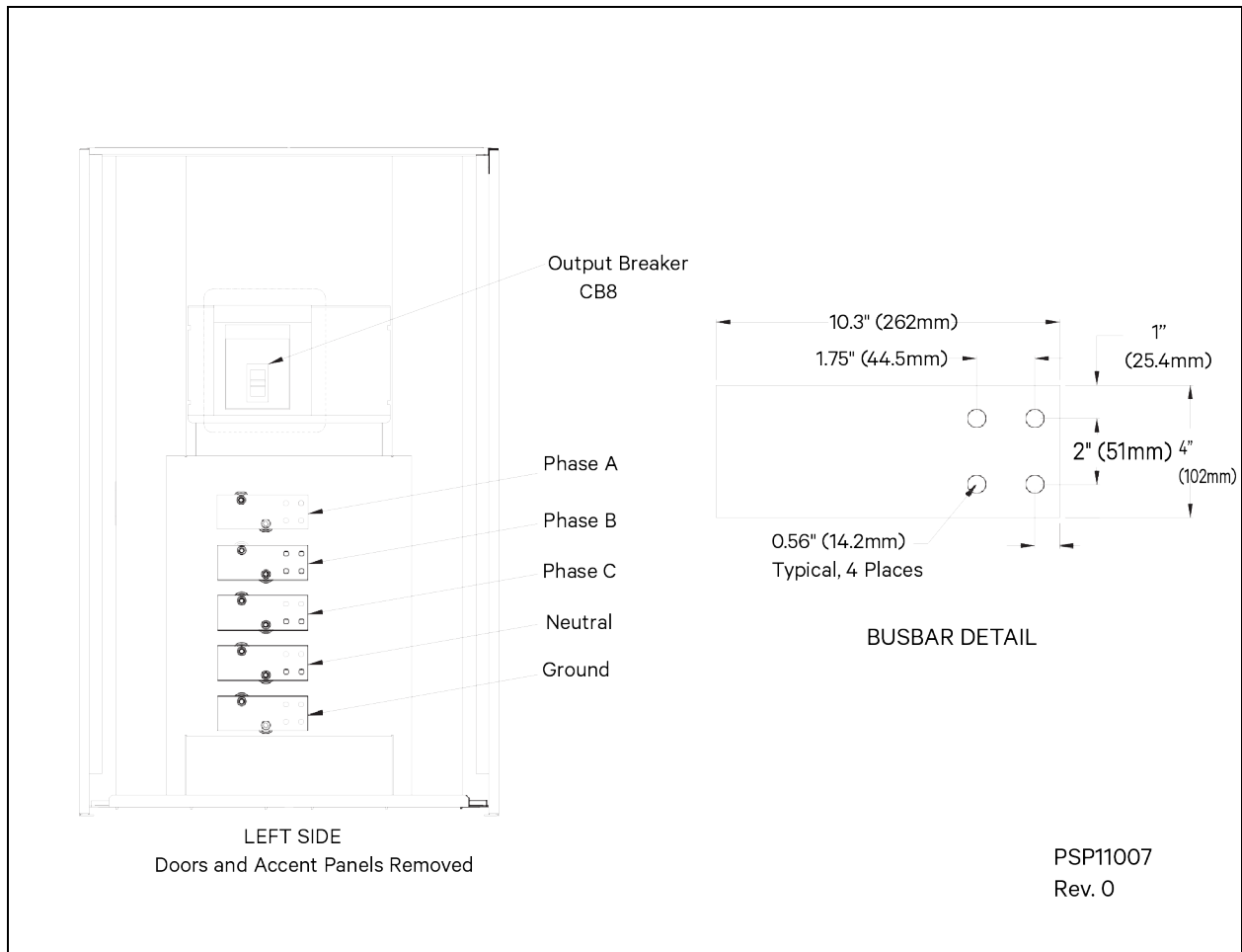

## NOTES TO FIGURE :

1. Phase and ground busbars are 1/4" thick.
2. Neutral busbar is 1/2" thick.

Figure 8.31 Electrical Field Connections, 800A Vertiv™ Liebert® STS2 / PDU Interconnect Wiring

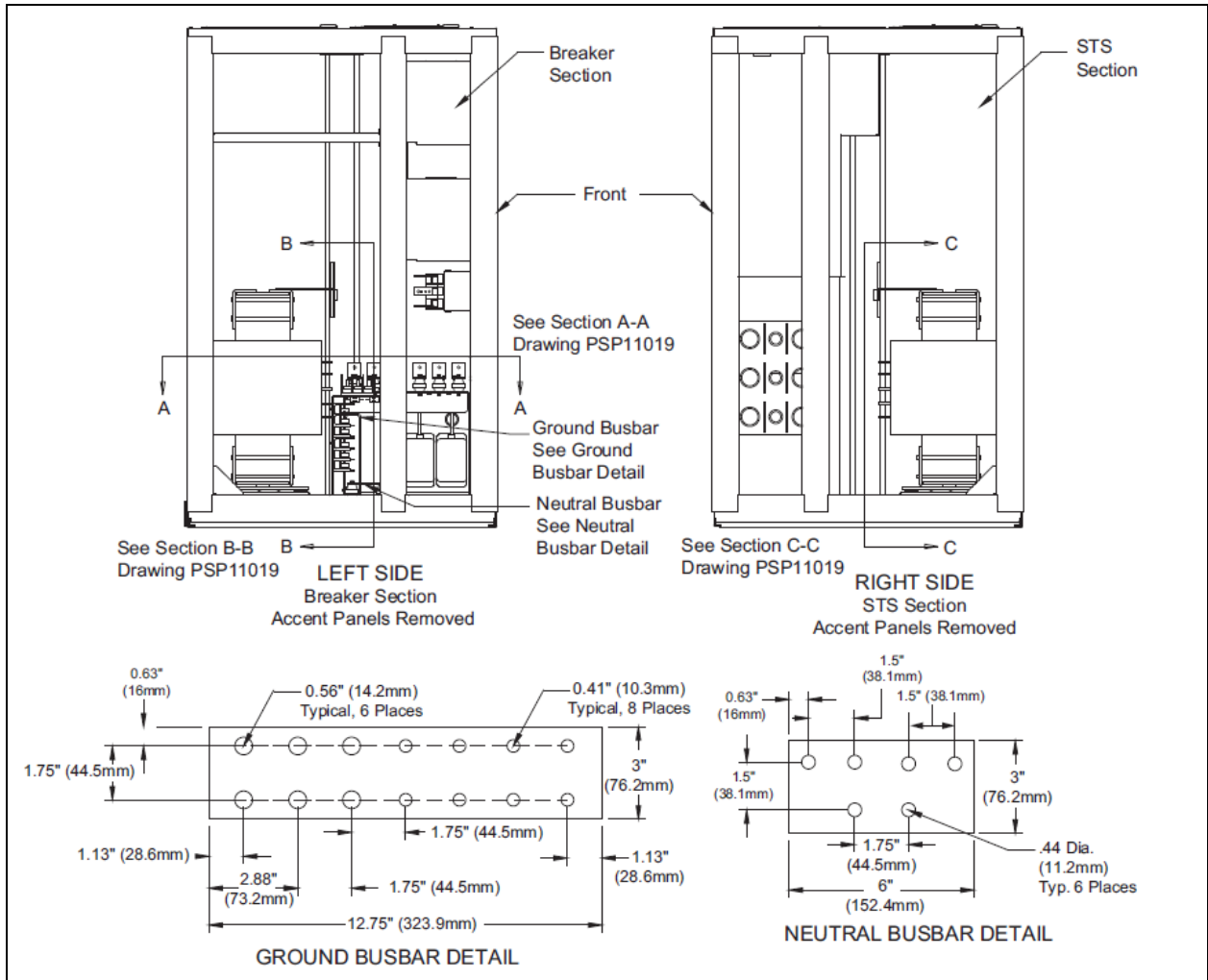

NOTES TO FIGURE :

1. Phase and ground busbars are 1/4" thick.
2. Neutral busbar is 1/2" thick.

Figure 8.32 Electrical Field Connections, 800A Vertiv™ Liebert® STS2 / PDU Interconnect Wiring, Breaker Section

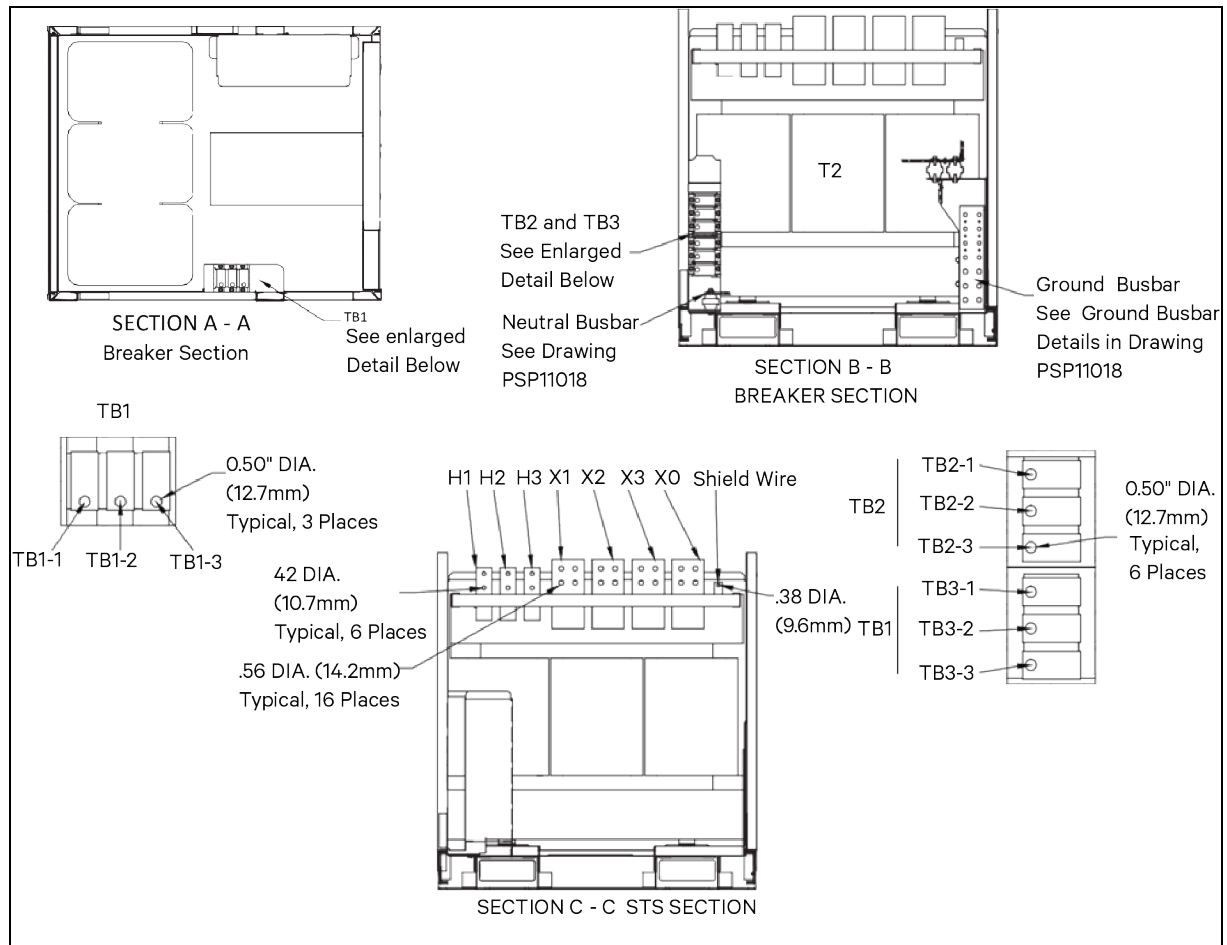

## NOTES TO FIGURE:

1. Interconnection wiring from T1 to TB1, 2, 3 and neutral busbars are attached to T1 and shipped in the STS section.
2. Refer to drawing PSP11018 for section location details and for neutral and ground busbar details.

Table 8.1 Interconnection wiring, from STS section to breaker

From T1	Section To	Wire Number
H1	TB1-1	7AA and 7BB
H2	TB1-2	8AA and 8BB
H3	TB1-3	9AA and 9BB
X1	TB2-1	13AA and 13BB
X1	TB2-2	13CC and 13DD
X2	TB2-3	14AA and 14BB
X2	TB3-1	14CC and 14DD

Figure 8.33 Electrical Field Connections, 800A Vertiv™ Liebert® STS2 / PDU Interconnect Wiring, STS Section

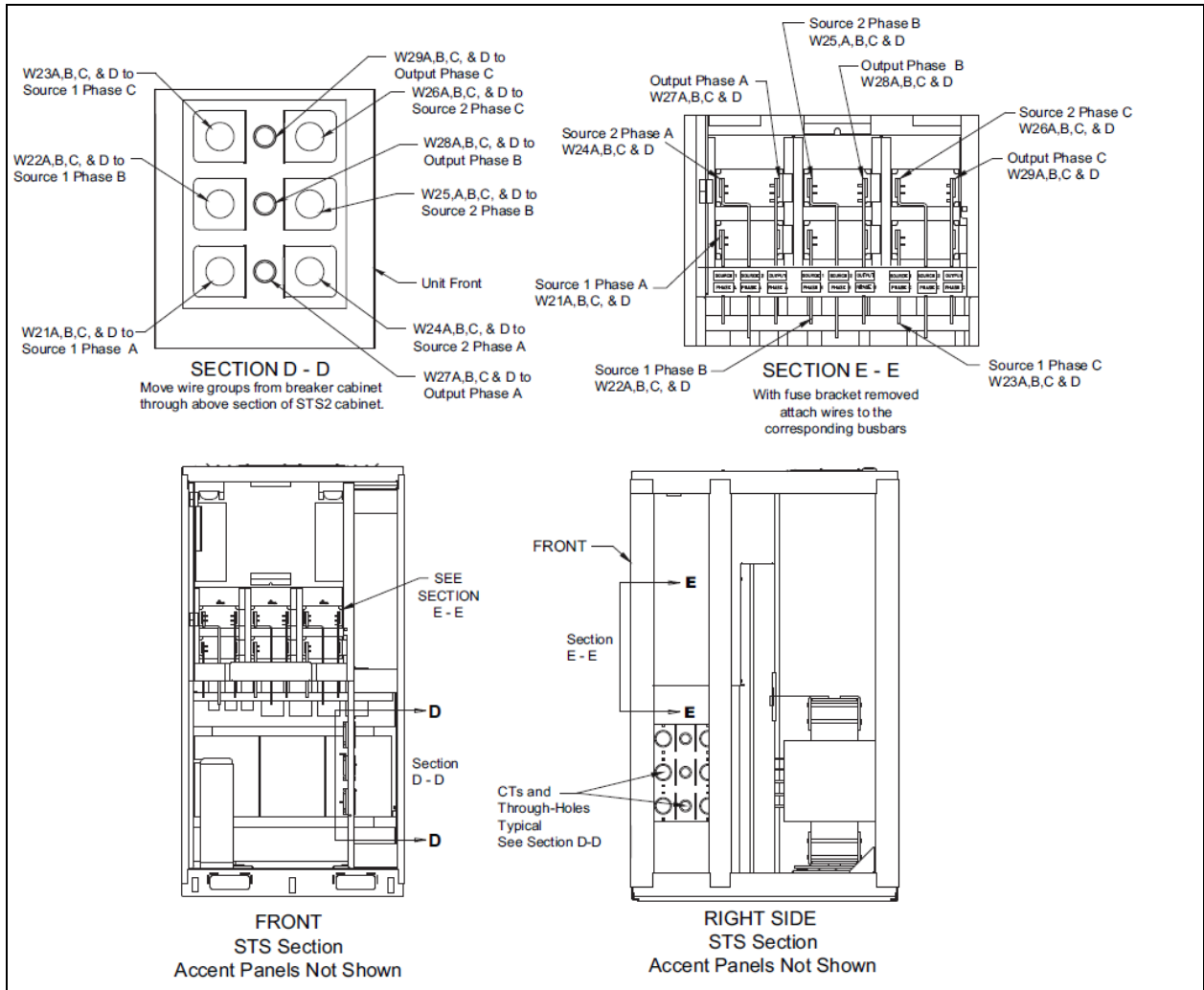

NOTES TO FIGURE:

1. Take labeled wires from breaker section (cabinet not shown) through CTs and through-holes of STS cabinet. Attach wires to busbars in STS cabinet.
2. See drawing PSP11018 for breaker section of cabinet.



**Figure 8.34 Electrical Field Connections, 800A Vertiv™ Liebert® STS2 / PDU Interconnect Wiring, Left Side Distribution Cabinet**

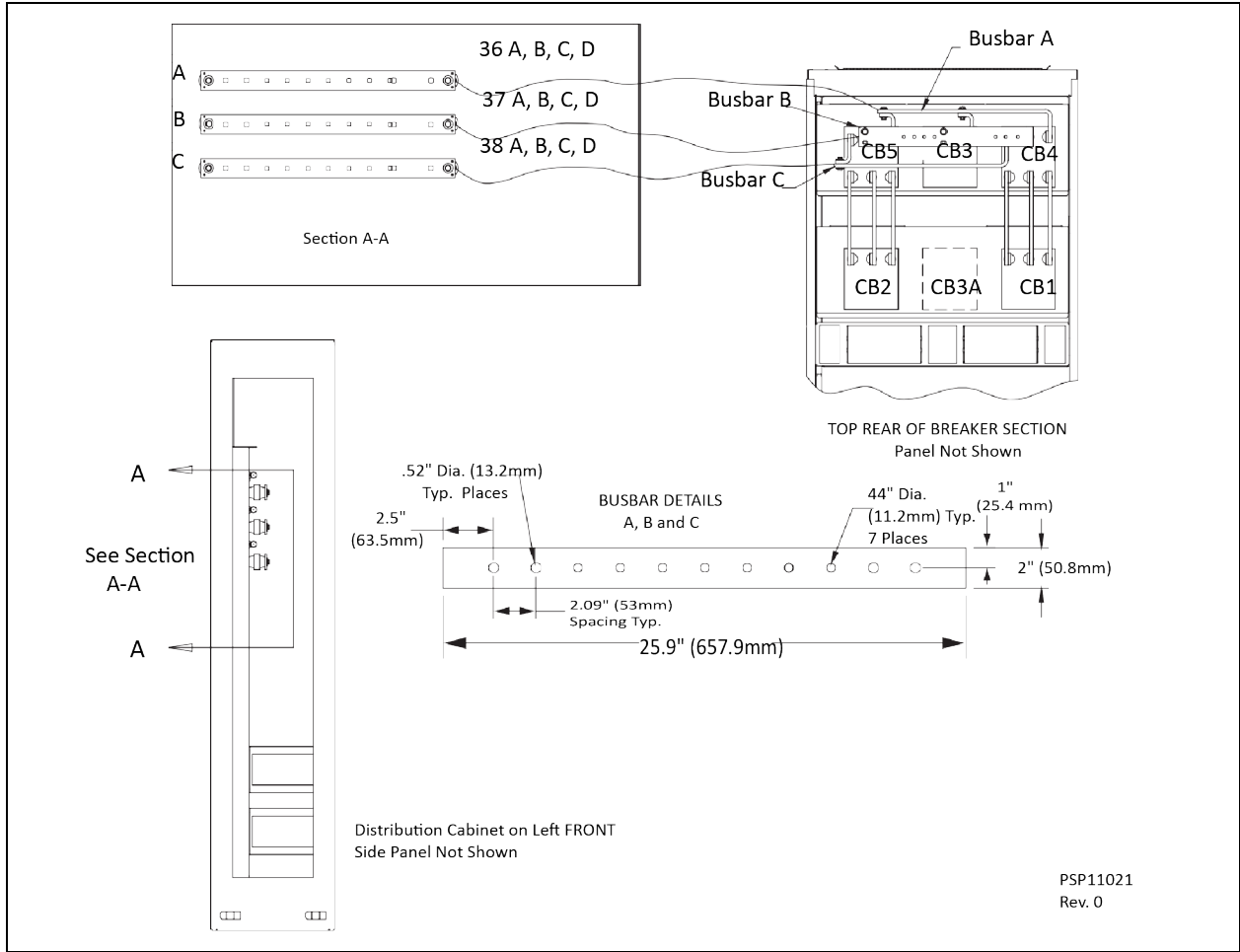

**NOTES TO FIGURE:**

1. The neutral is factory-wired.
2. Interconnection wiring from breaker busbars A, B and C to Distribution Section are attached to breaker busbars and shipped in the breaker section.

**Table 8.2 Interconnection wiring from Breaker Section to Distribution Section**

From Breaker Busbar	To Distribution Busbar	Wire Number
A	A	36A, B, C, D
B	B	37A, B, C, D
C	C	38A, B, C, D

Figure 8.35 Electrical Field Connections, 800A Vertiv™ Liebert® STS2 / PDU Interconnect Wiring, Left Side One-line

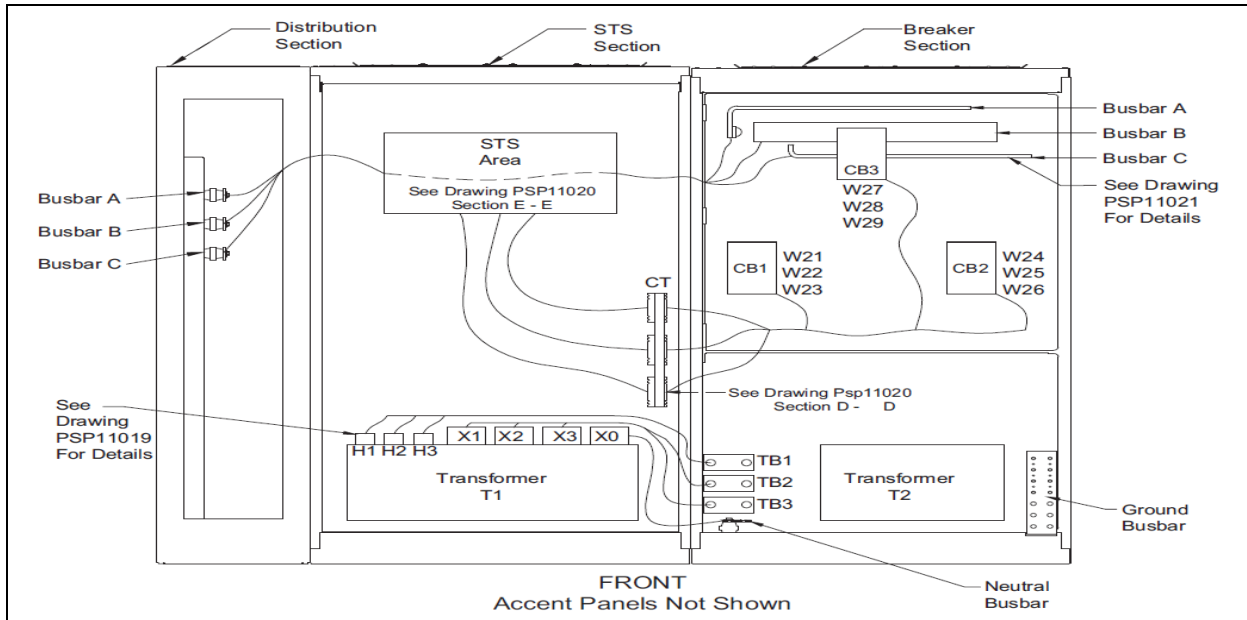

NOTES TO FIGURE:

1. Interconnection wiring from T1 to TB1, 2, 3 and neutral busbars are attached to T1 and shipped in the STS section. See Drawing PSP11019 for details.
2. Interconnection wiring from CB1, CB2 and CB3 to STS section are attached to CB1, CB2, & CB3 and shipped in the breaker section. See Drawing PSP11020 for details.
3. Interconnection wiring from breaker. Busbars a, b and c to distribution section are attached to brkr. Busbars and shipped in the breaker section. See Drawing PSP11021 for details.

Figure 8.36 Electrical Field Connections, 800A Vertiv™ Liebert® STS2 / PDU Interconnect Wiring, Left Side One-line with CB3A

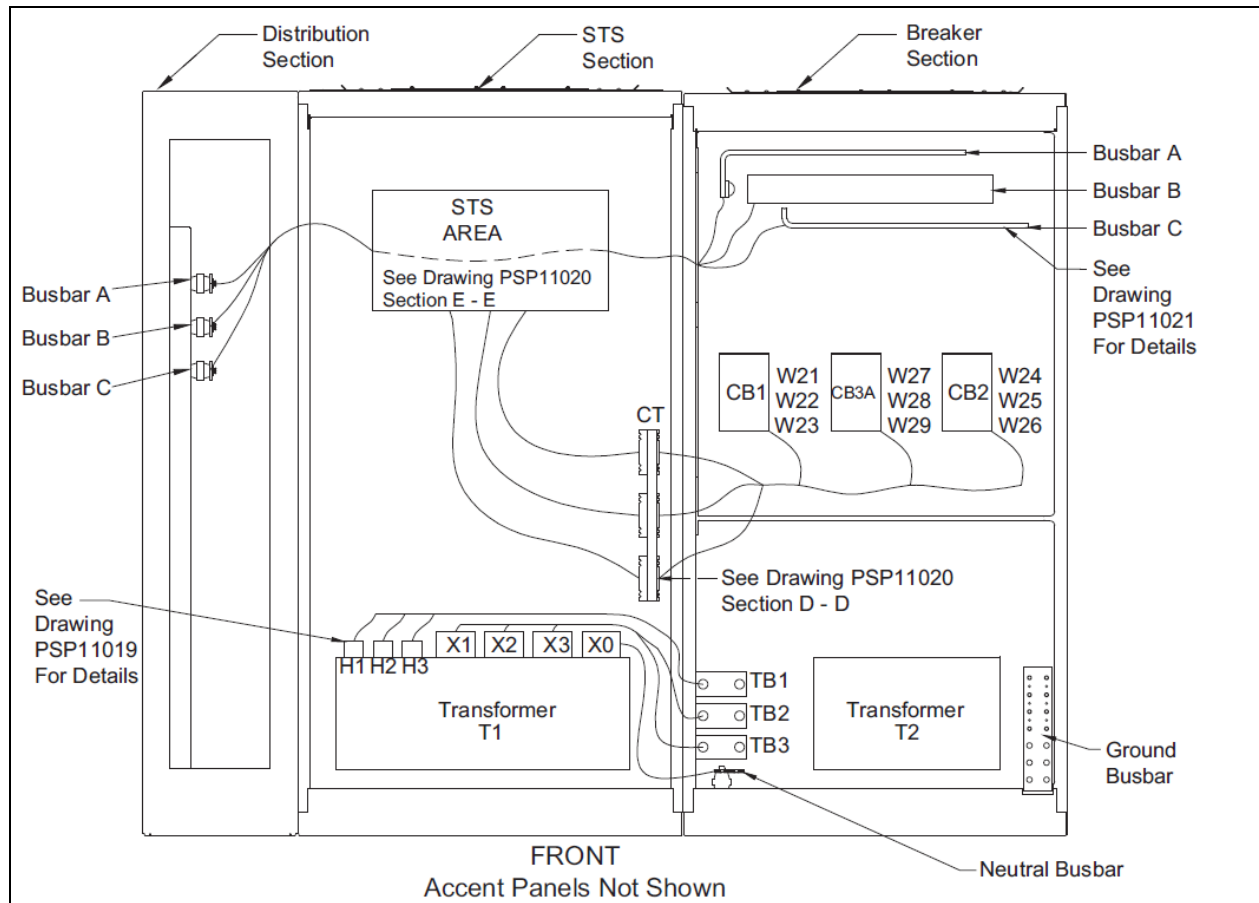

NOTES TO FIGURE:

1. Interconnection wiring from T1 to TB1, 2, 3 and neutral busbars are attached to T1 and shipped in the STS section. See drawing PSP11019 for details.
2. Interconnection wiring from CB1, CB2 and CB3A to STS section are attached to CB1, CB2 and CB3A and shipped in the breaker section. See drawing PSP11020 for details.
3. Interconnection wiring from breaker busbars A, B and C to distribution section are attached to breaker busbars and shipped in the breaker section. See dwg PSP11021 for details.

**Figure 8.37 Electrical Field Connections, 800A Vertiv™ Liebert® STS2 / PDU Interconnect Wiring, Right Side**

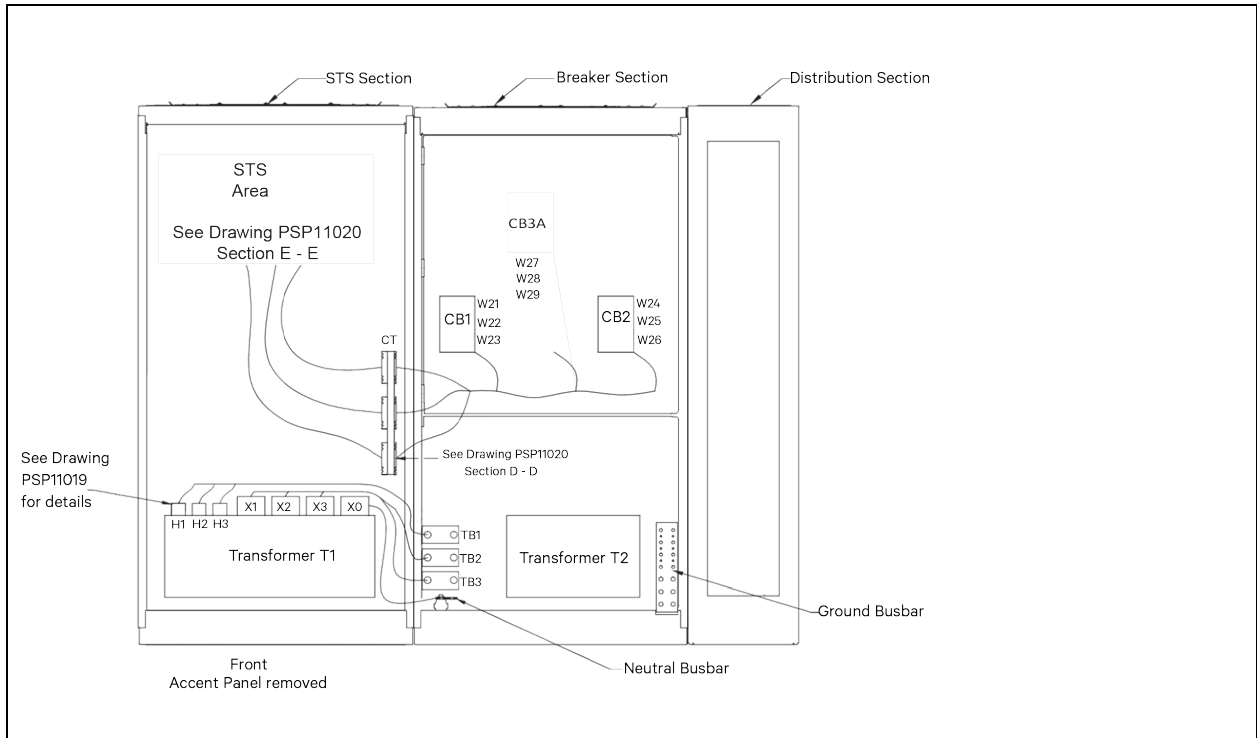

**NOTES TO FIGURE:**

1. Interconnection wiring from T1 to TB1, 2, 3 and neutral busbars are attached to T1 and shipped in the STS section. See drawing PSP11019 for details.
2. Interconnection wiring from CB1, CB2 and CB3 to STS section are attached to CB1, CB2 and CB3 and shipped in the breaker section. See drawing PSP11020 for details.

**Figure 8.38 Electrical field connections, 800A Vertiv™ Liebert® STS2 / PDU Interconnect Wiring, Right Side**

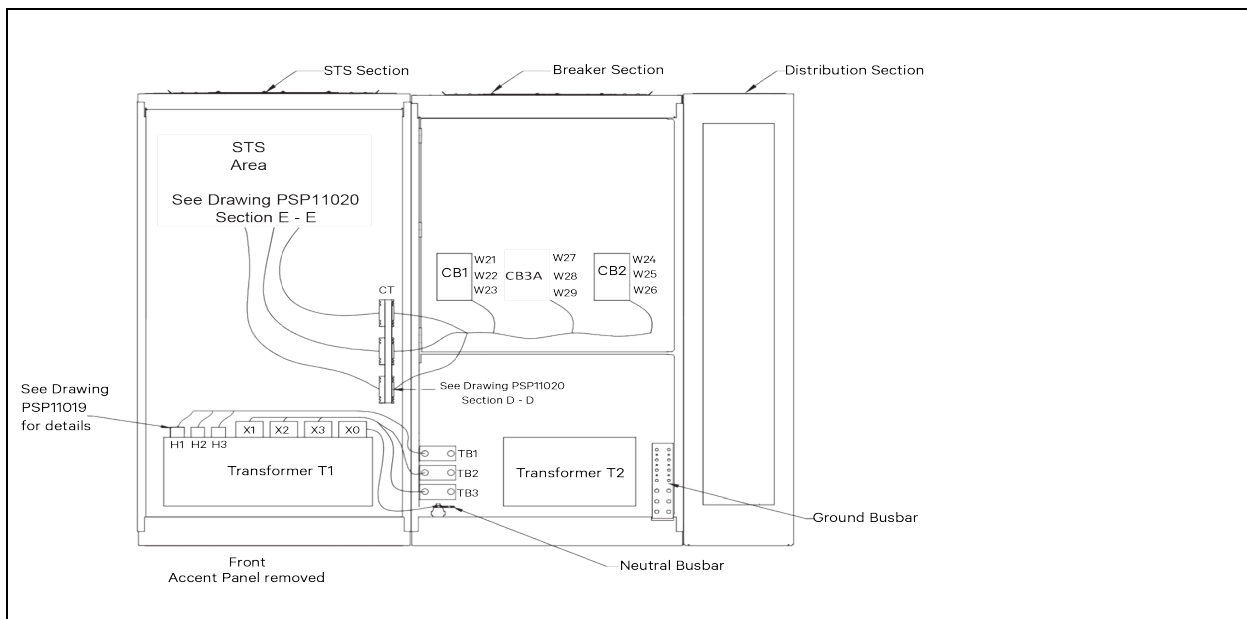

## NOTES TO FIGURE:

1. Interconnection wiring from T1 to TB1, 2, 3 and neutral busbars are attached to T1 and shipped in the STS section. See drawing psp11019 for details.
2. Interconnection wiring from CB1, CB2 and CB3A to STS section are attached to CB1, CB2 and CB3A and shipped in the breaker section. See drawing PSP11020 for details.

Figure 8.39 Control Wiring, 800A Vertiv™ Liebert® STS2 / PDU, Left Side Distribution

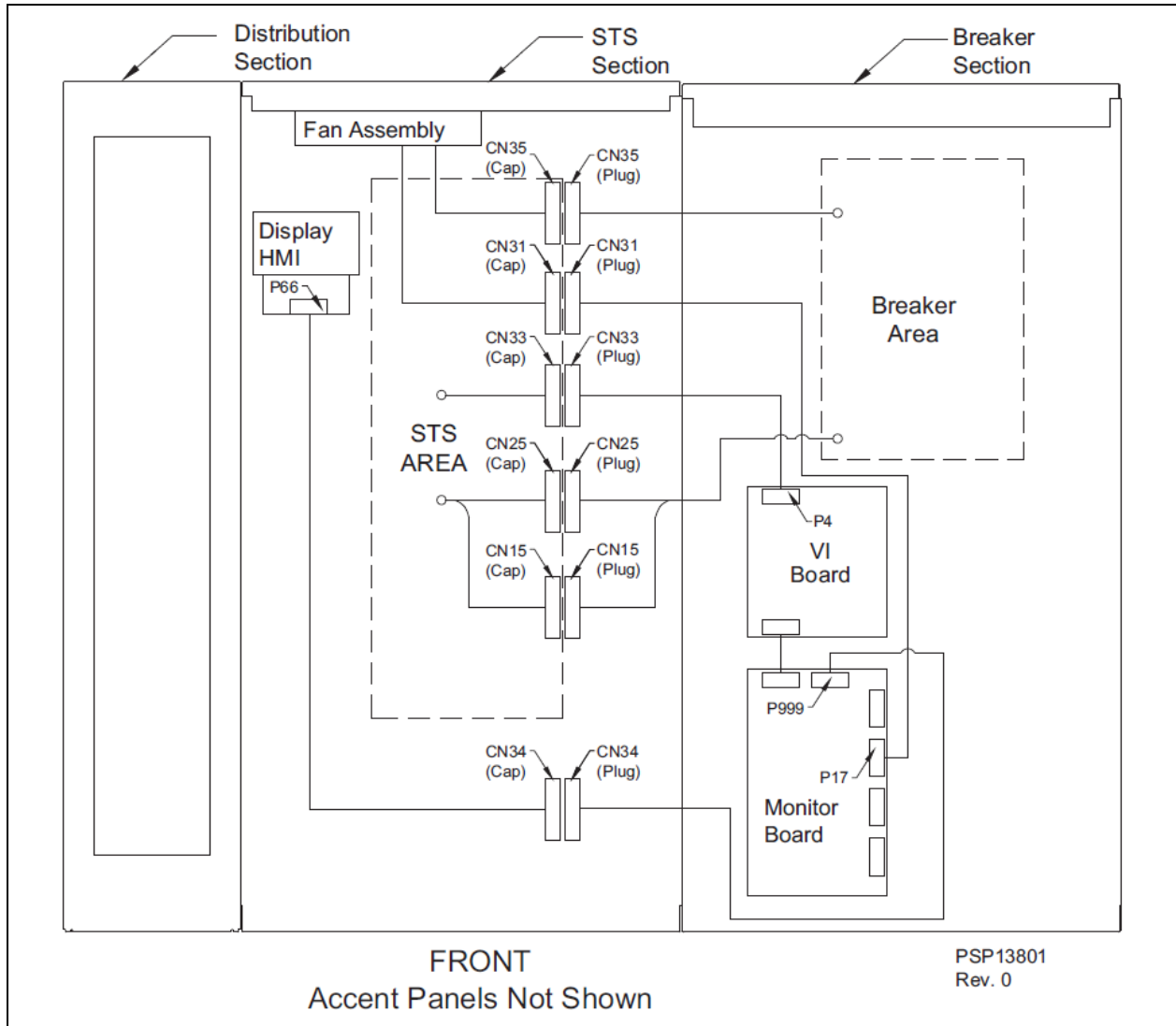

Connect the Following

- CN15 Cap to CN15 Plug
- CN25 Cap to CN25 Plug
- CN31 Cap to CN31 Plug
- CN33 Cap to CN33 Plug
- CN34 Cap to CN34 Plug
- CN35 Cap to CN35 Plug

Figure 8.40 Control Wiring, 800A Vertiv™ Liebert® STS2 / PDU, Right Side distribution

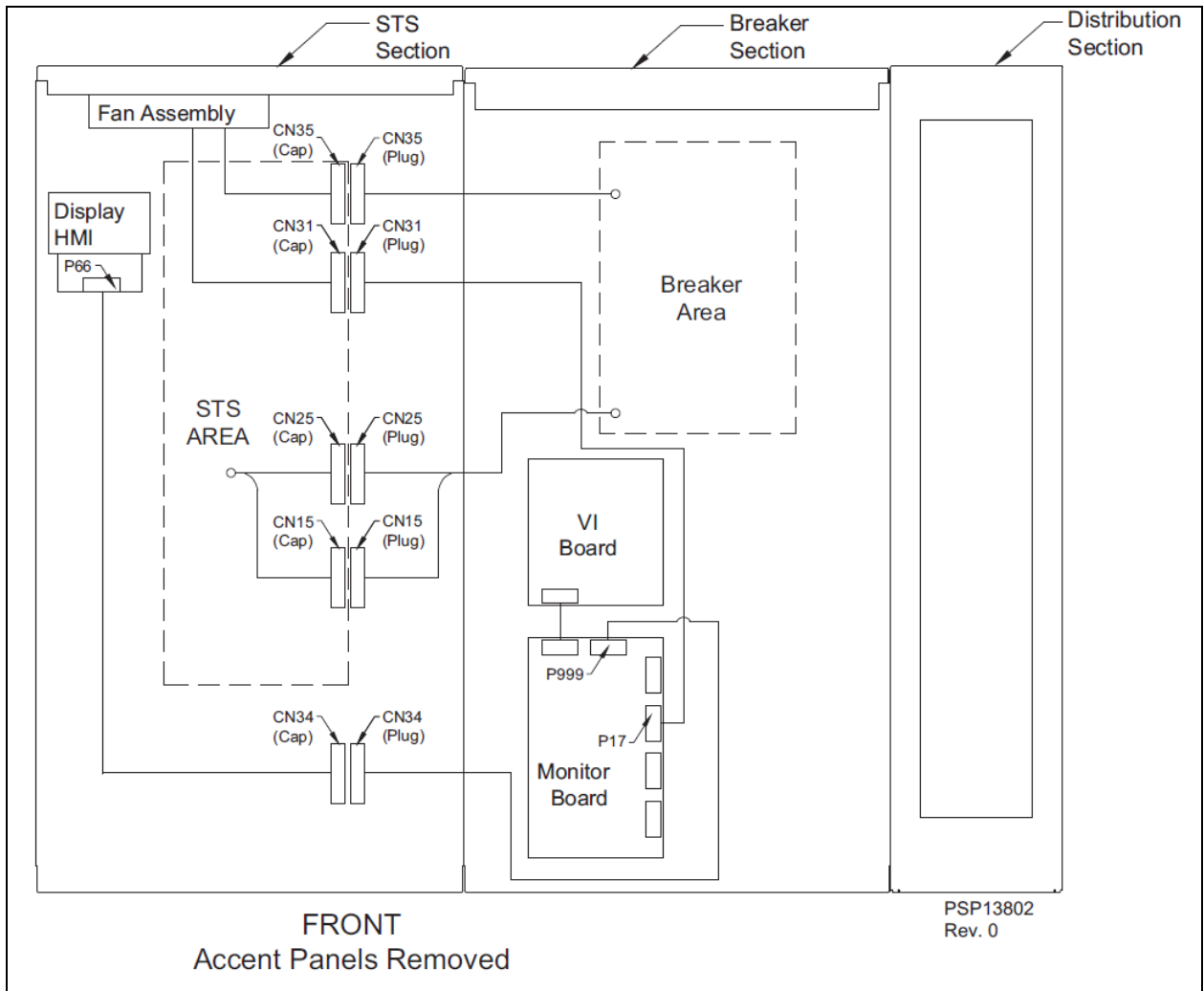

Connect the Following:

- CN15 Cap to CN15 Plug
- CN25 Cap to CN25 Plug
- CN31 Cap to CN31 Plug
- CN34 Cap to CN34 Plug
- CN35 Cap to CN35 Plug

Figure 8.41 Control Connection Location, 250A Vertiv™ Liebert® STS2 / PDU

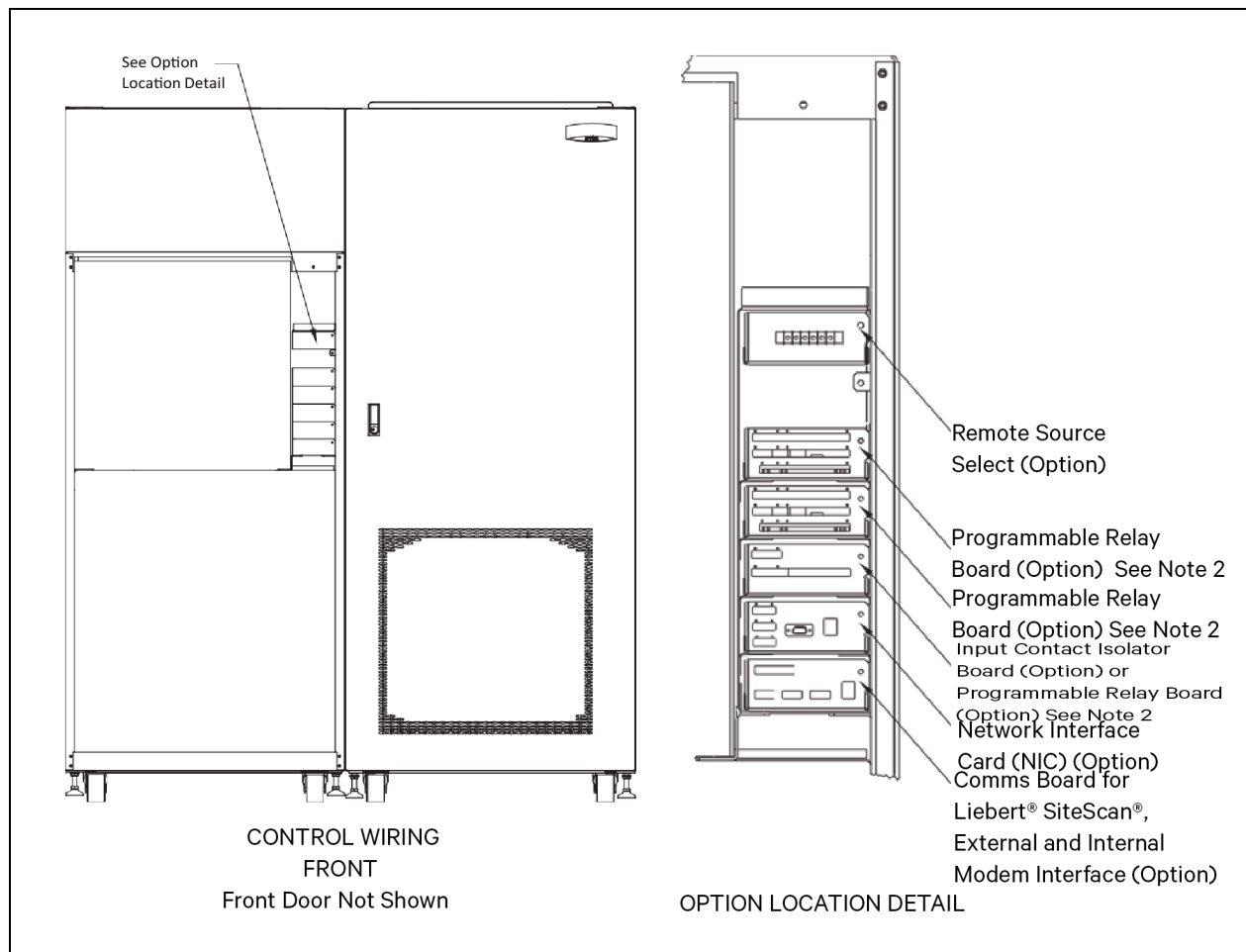

## NOTES TO FIGURE:

1. Typical options are shown.
2. Maximum of two programmable relay boards can be used.

Figure 8.42 Control Connection Location, 400-800A Vertiv™ Liebert® STS2 / PDU

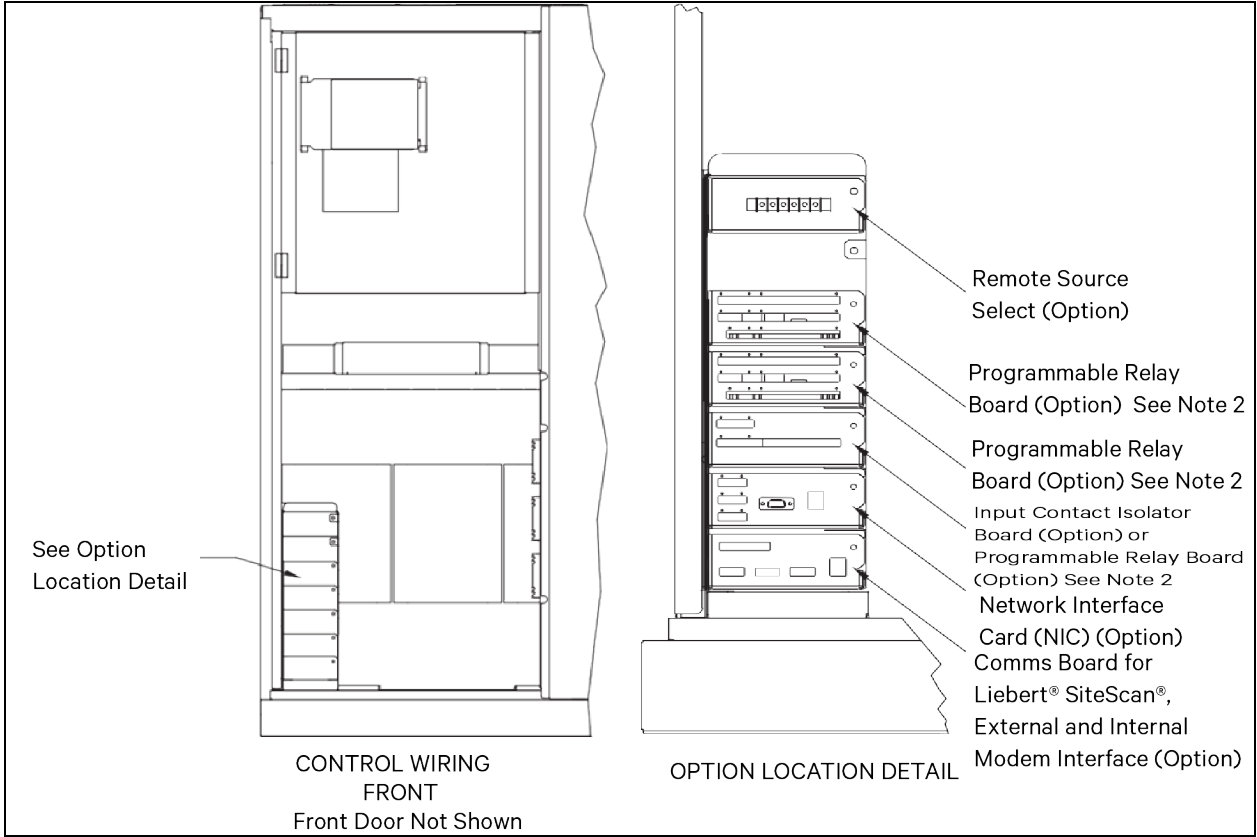

NOTES TO FIGURE:

- 1. Typical options are shown.
- 2. Maximum of two programmable relay boards can be used.



Figure 8.43 Control Location Drawing Conduit Box, Top Entry, 400-600A Vertiv™ Liebert® STS2 / PDU

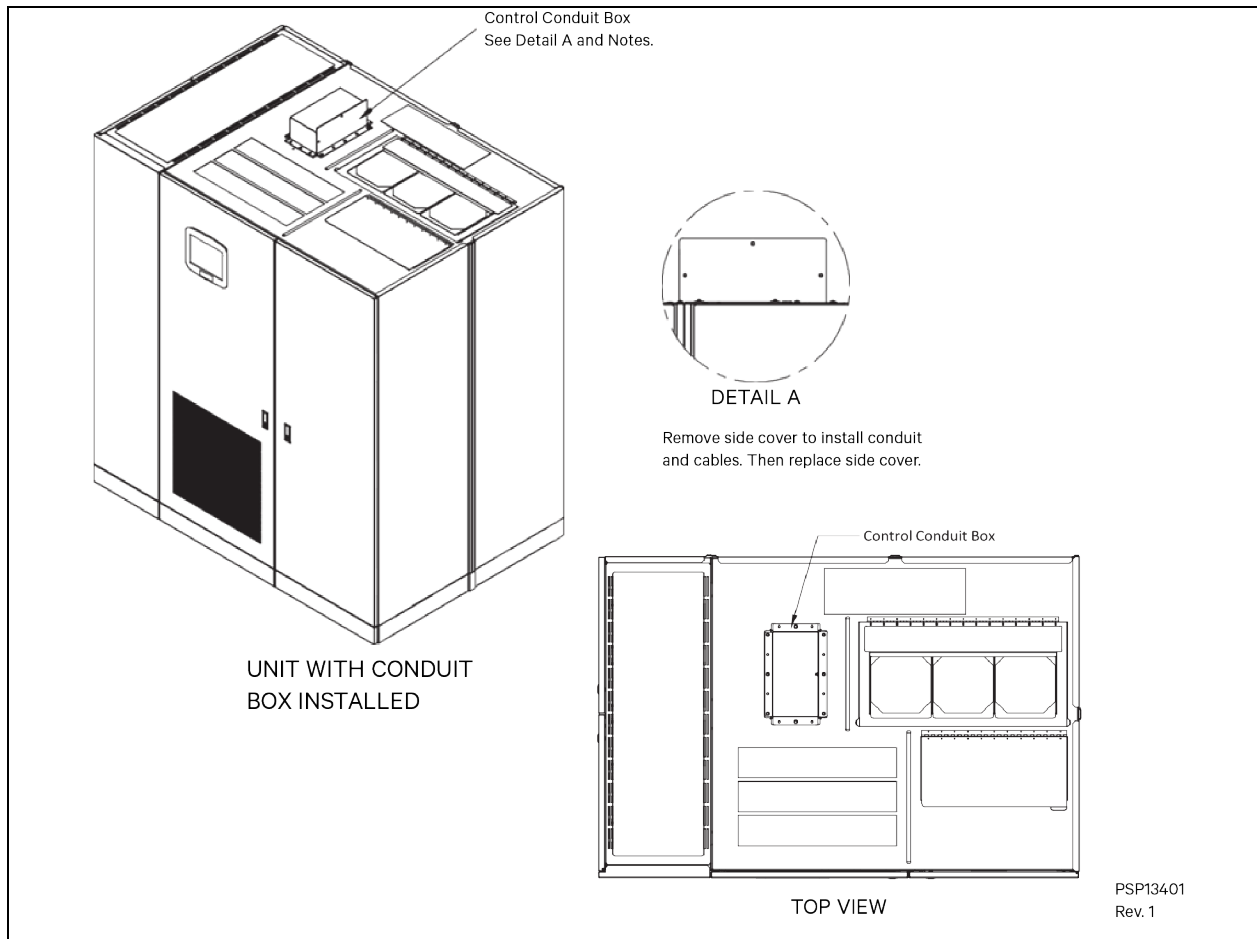

## NOTES TO FIGURE:

1. The control conduit box is mounted upside down and inside of top of the unit for shipping.
2. Remove the box and side cover.
3. Drill top of box for conduits.
4. Replace the box as shown in the installed view.
5. Install conduit and land cables.
6. Replace side cover.

**Figure 8.44 Control Wiring for the Programmable Relay Board Option**

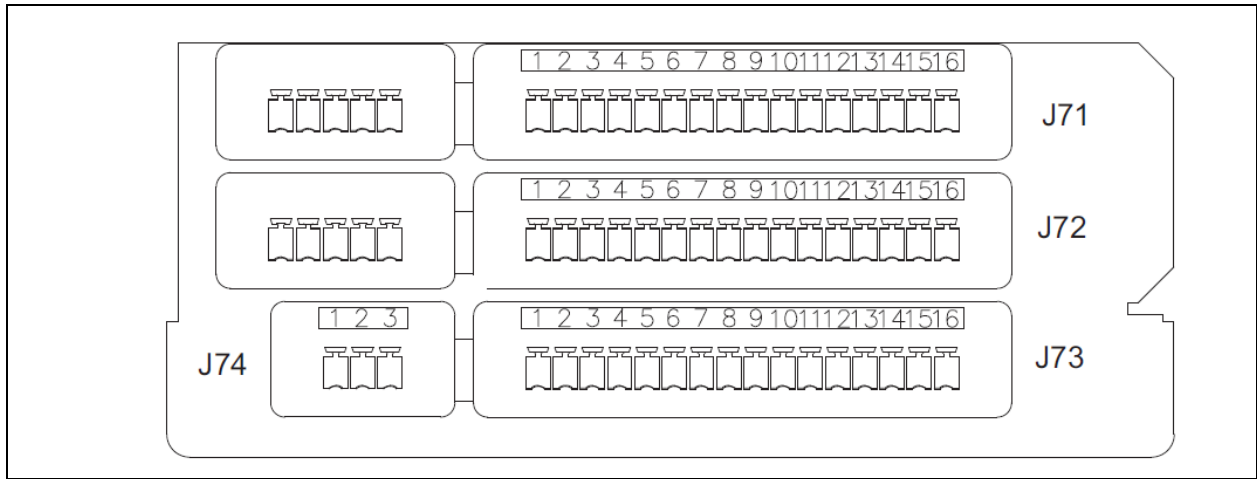

**NOTES TO FIGURE:**

1. Customer control wiring connection points are Terminal Blocks 1 through 15.
2. Programmable relay board option includes eight signal channels with two Form-C dry contacts per channel. See **Table 8.3** below . (C=Common, NC=Normally Closed, NO=Normally Open)
3. Refer to other portions of this document for configuring the programmable relay board option.
4. All control wiring (by others) must be run separate from power wiring. Control wiring runs should not be combined in the same conduit.
5. Refer to static transfer switch control connection diagram for location of program relay board option.
6. Contact ratings: 1amp @ 30VDC, 200mA @125VAC.
7. Maximum cable length 500 ft. (152m) with #16AWG flexible stranded cable.
8. All wiring must be in accordance with national and local electrical codes.

**Table 8.3**

		CHANNEL	PIN NO.	C	NC	NO
J71	CH1	A	1 - 3	1	2	3
		B	4 - 6	4	5	6
	CH2	A	7 - 9	7	8	9
		B	10 - 12	10	11	12
	CH3	A	13 - 15	13	14	15
		B	1 - 3	1	2	3
J72	CH4	A	4 - 6	4	5	6
		B	7 - 9	7	8	9
	CH5	A	10 - 12	10	11	12
		B	13 - 15	13	14	15

Table 8.3 (continued)

	CHANNEL		PIN NO.	C	NC	NO
J73	CH6	A	1-3	1	2	3
		B	4-6	4	5	6
	CH7	A	7-9	7	8	9
		B	10-12	10	11	12
J74	CH8	A	13-15	13	14	15
		B	1-3	1	2	3

Figure 8.45 Control Wiring for the Input Contact Isolator Board Option

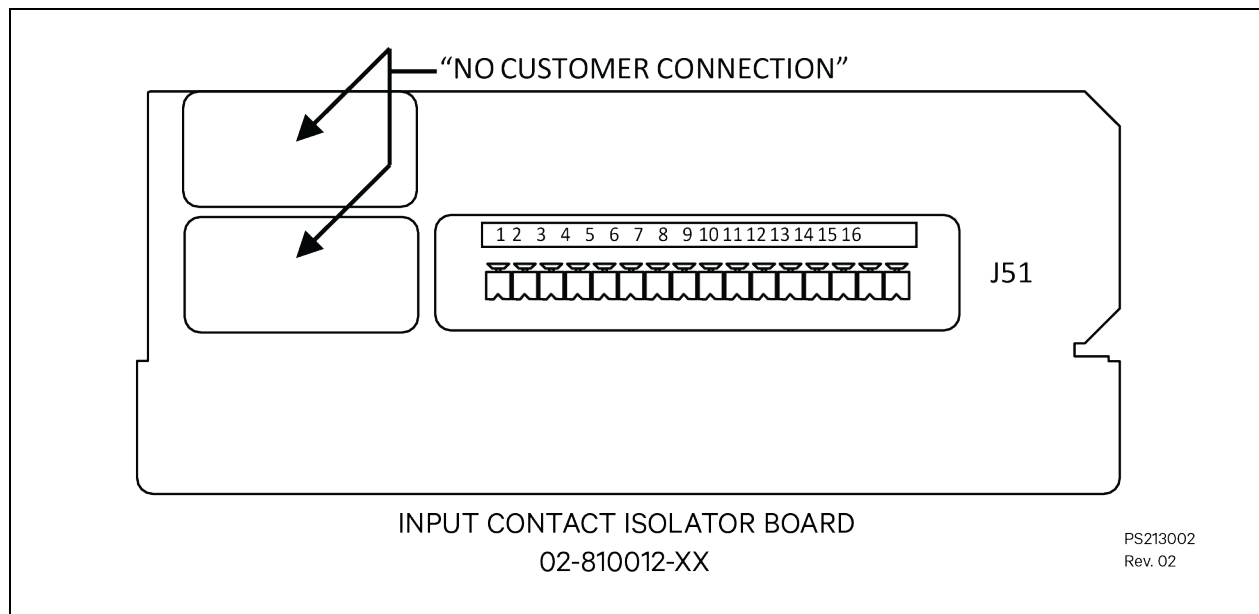

## NOTES TO FIGURE :

1. Customer control wiring connection points are Terminals 1 through 16 (see **Table 8.4** on the next page ).
2. Customer-provided, normally open, dry contacts for user alarm messages.
3. Refer to installation, operation AND maintenance manual for configuring the input contact isolator board option.
4. All control wiring (by others) must be run separate from power wiring. Control wiring runs should not be combined in the same conduit.
5. Refer to static transfer switch control connection diagram for location of input contact isolator board option.
6. Signal voltage: 100mA @ 12VDC.
7. Maximum cable length 500 ft. (152 meters) with #16 AWG flexible, stranded cable.
8. All wiring must be in accordance with national and local electrical codes.

**Table 8.4 J51**

Input Contact	Pin No.
1	1
	2
2	3
	4
3	5
	6
4	7
	8
5	9
	10
6	11
	12
7	13
	14
8	15
	16

**Figure 8.46 Control Wiring for Comms Board**

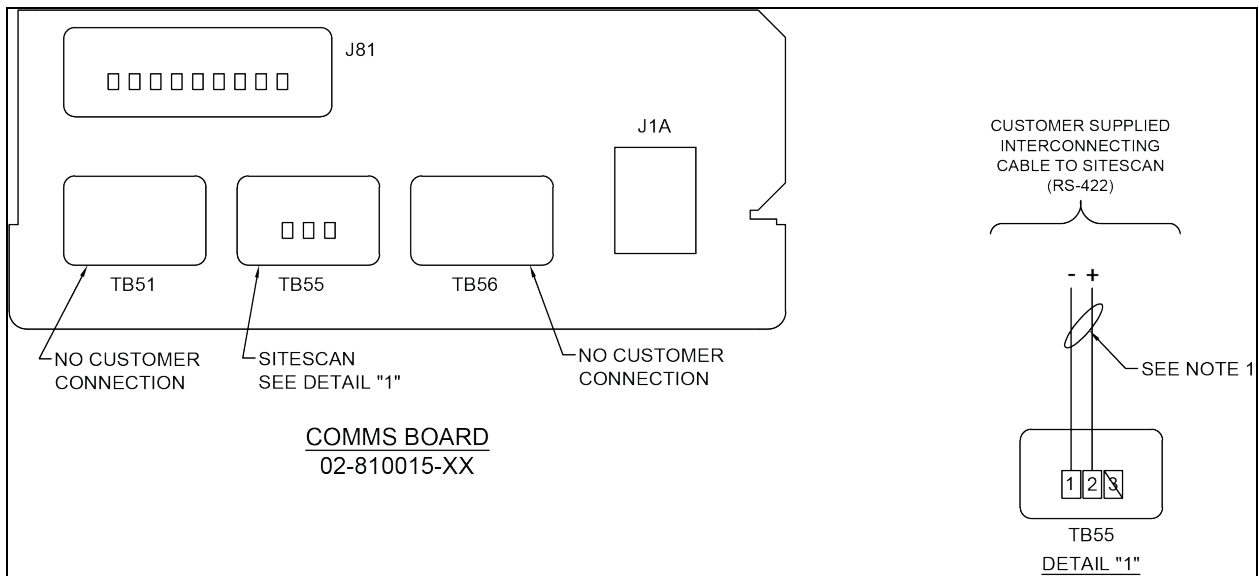

## NOTES TO FIGURE :

1. Maximum cable length 1000 ft. (300m) with twisted pair cable #22 AWG 300V minimum.
2. All control wiring (by others) must be run separate from power wiring. Control wiring runs should not be combined in the same conduit.
3. Refer to control connection location diagram of static transfer switch for location of Comms Board.
4. All wiring must be in accordance with national and local electrical codes.

Figure 8.47 Control Wiring for the Vertiv™ Liebert® IntelliSlot Unity Card Option

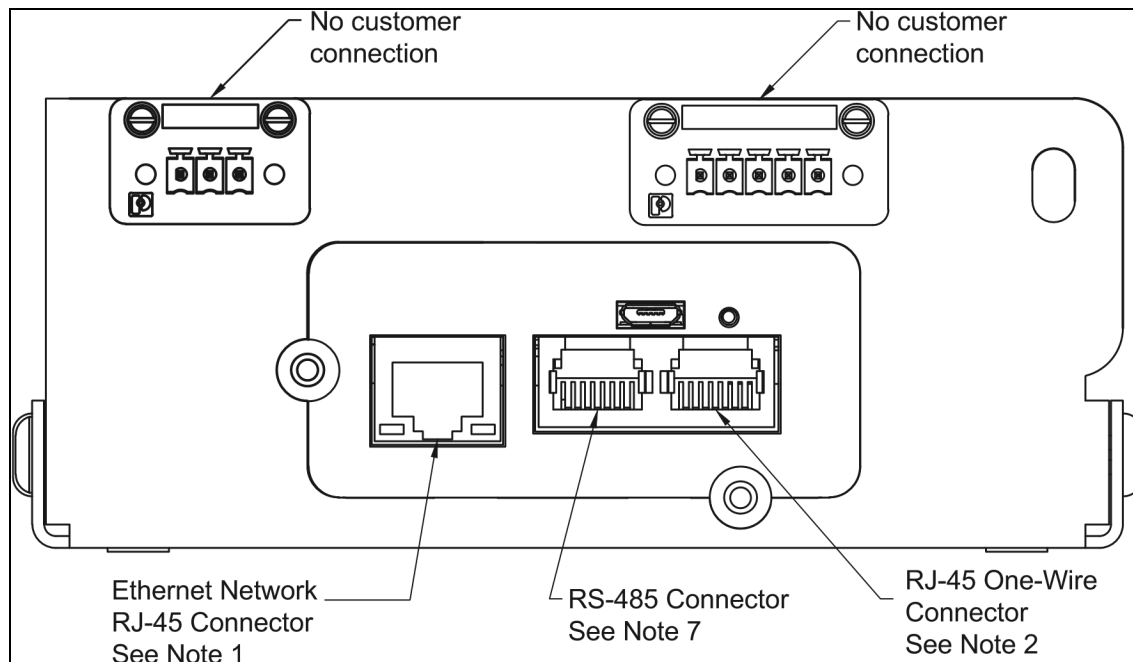

## NOTES TO FIGURE :

1. Wire size and type: Standard category 5e cable with RJ-45 connector. Maximum length is 328 ft. (100m).
2. Liebert integrated one-wire sensor cable or 2m Cat 5e to modular one-wire sensor. Maximum length 65.6 ft. (20m).
3. Refer to the Liebert® IntelliSlot Unity-DP Card's installation, operation and maintenance manual for configuring the card.
4. All control wiring (by others) must be run separate from power wiring. Control wiring runs should not be combined in the same conduit.
5. Refer to control connection location diagram of static transfer switch for location of Liebert® IntelliSlot Unity-DP card option.
6. All wiring must be in accordance with national and local electrical codes.
7. RS-485 requires the use of the RJ-45 adapter provided with the Liebert® IntelliSlot Unity-DP Card (P/N RJ-45-2POS). Refer to the Liebert® IntelliSlot Unity-DP card's manual for details.

Figure 8.48 Control Wiring for the RS-232 Port

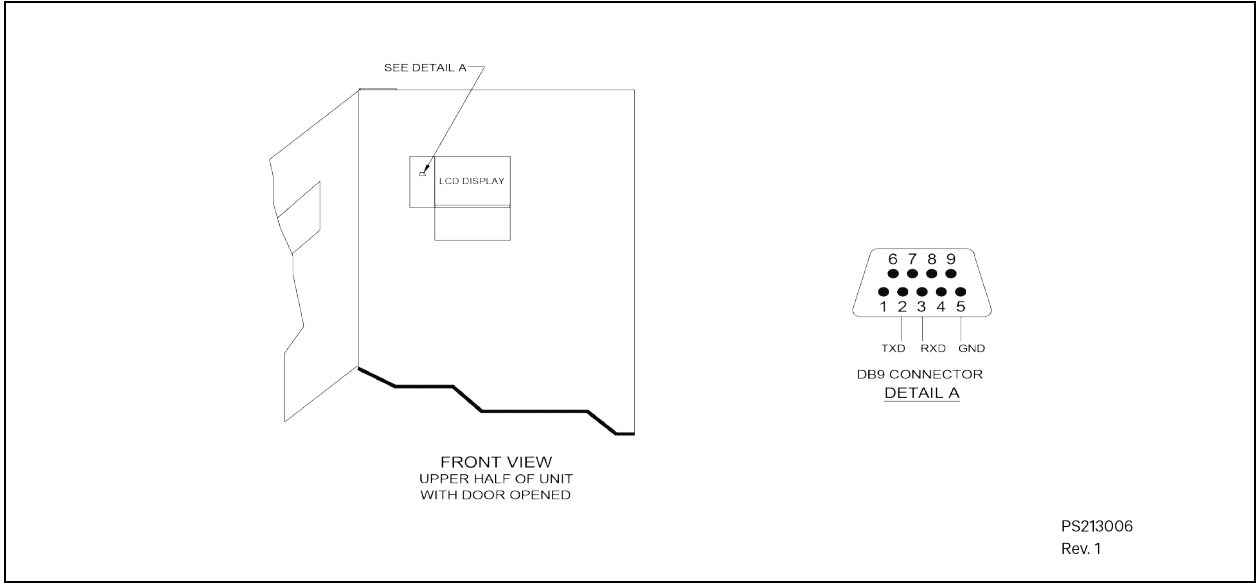

NOTES TO FIGURE :

- 1. RS-232 communication through DB9 connector.
- 2. Connector accessible with front door opened. connector must be removed before closing door.

Figure 8.49 Control Wiring for Remote Source Selection Option

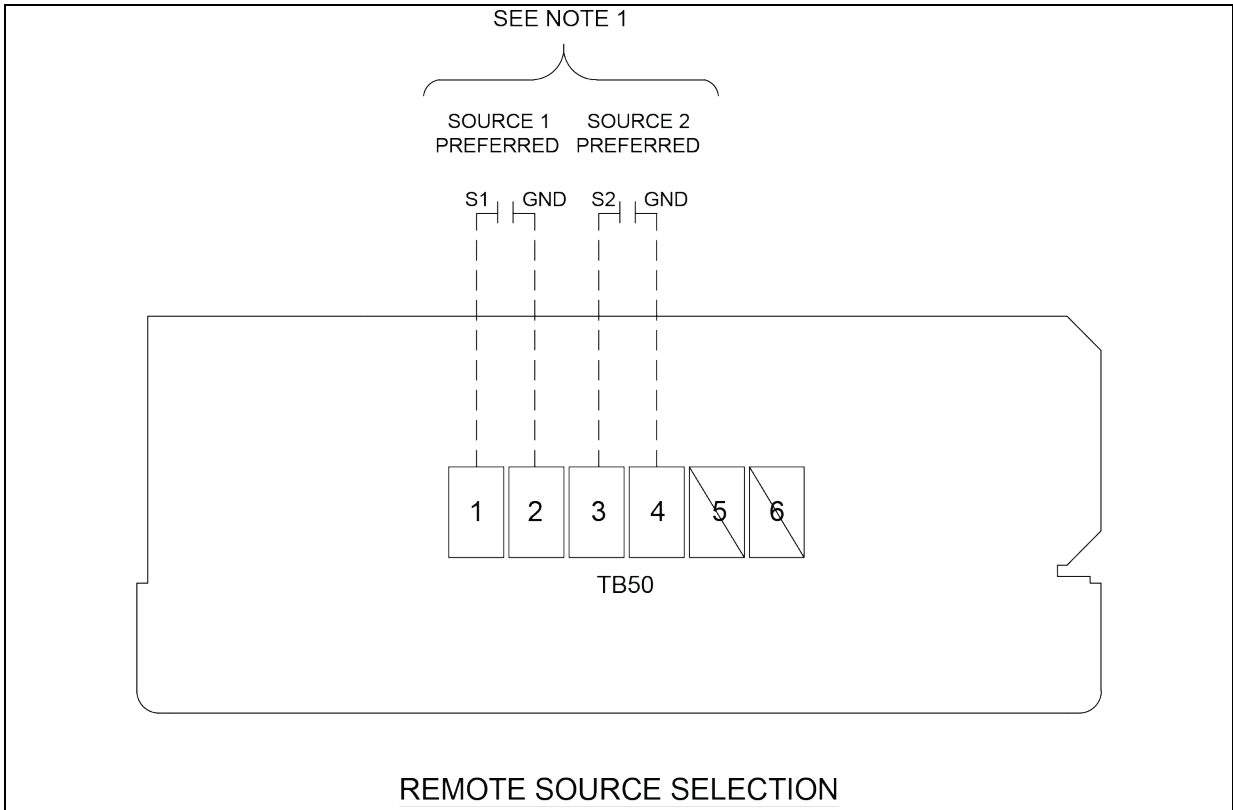

NOTES TO FIGURE :

1. Customer provided normally open dry contacts. rating 10mA at 30VDC.
2. Maximum cable length 500 ft. (152m) with #16AWG 300V minimum, flexible stranded cable.
3. All control wiring (by others) must be run separately from power wiring. Control wiring runs should not be combined in the same conduit.
4. Refer to static transfer switch control connection diagram for location of remote source selection opt.
5. All wiring must be in accordance with national and local electrical codes.

Figure 8.50 Color LCD Touchscreen

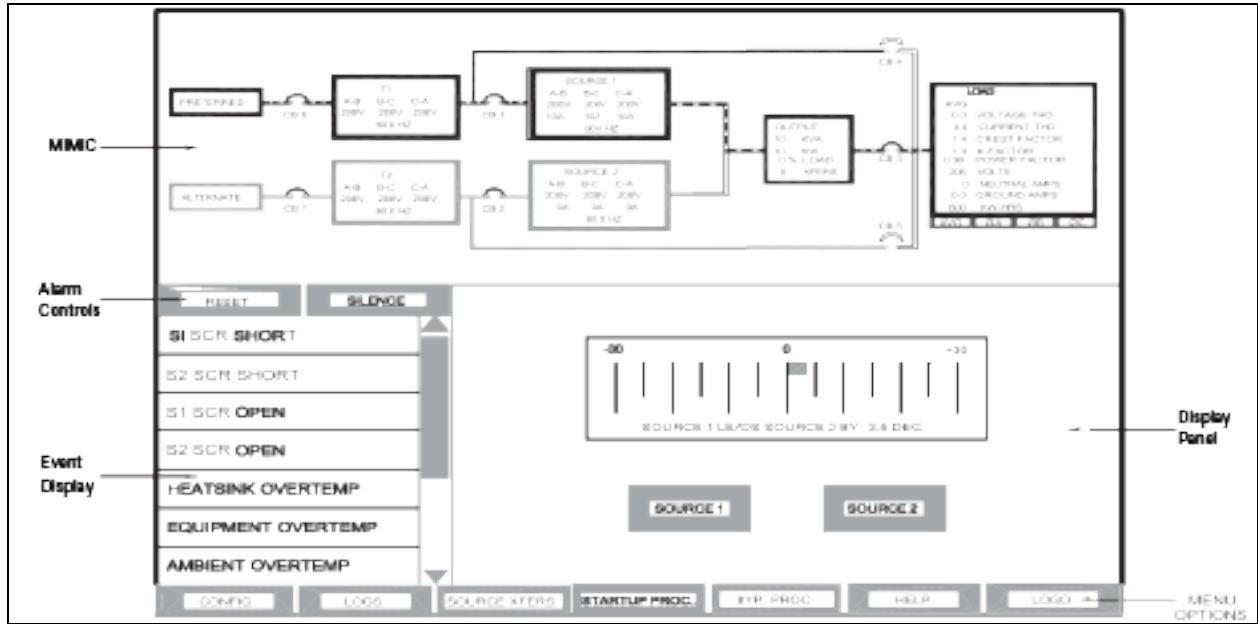

Table 8.5 Input Circuit Breaker Schedule, 250-800A

Liebert® STS2 / PDU Rating	Liebert® STS2 / PDU Input Volts	Circuit Breakers (See One-Line Diagrams)	Vendor	Type	Ampacity	Voltage	Interrupting Rating (Amps)
250A	208V	CB6 & CB7	MERLIN GERIN	NJHN	400A	208-240V	100K
	480V			NFNN	150A	380-480V	35K
	600V			NFNN	125A	600V	18K
400A	480V	CB6 & CB7	MERLIN GERIN	NJHN	250A	380-480V	65K
	600V			NJHN	200A	600V	25K
600A	480V	CB6 & CB7	MERLIN GERIN	NJHN	400A	380-480V	65K
	600V			NJHN	300A	600V	25K
800A	480V	CB6 & CB7	MERLIN GERIN	NJHN	500A	380-480V	65K
	600V			NJHN	400A	600V	25K

**Table 8.6 Output circuit Breaker Schedule, 250-800A**

Liebert® STS2 / PDU Rating	Liebert® STS2 / PDU Input Volts	Circuit Breakers (See One-Line Diagrams)	Vendor	Type	Ampacity	Voltage	Interrupting Rating (Amps)
250A	208V	CB8	MERLIN GERIN	NJHN	250A	208-240V	100K
400A	208V	CB8	MERLIN GERIN	NJHN	400A	208-240V	100K
600A	208V	CB8	Square D	PGD	600A	208-240V	65K
800A	208V	CB8	Square D	PGD	800A	208-240V	65K

**Table 8.7 Non-automatic Breaker Schedule, 250-800A**

Liebert® STS2 / PDU Rating	Circuit Breakers (See One-Line Diagrams)	Vendor	Type	Ampacity	Voltage	Withstand Current
250A	CB1, CB2, CB3 CB3A, CB4, CB5	Square D	JLN	250A	208-240V	125K
					380-480V	100K
400A	CB1, CB2, CB3 CB3A, CB4, CB5	MERLIN GERIN	NSJ	400A	208-240V	100K
					380-480V	100K
600A	CB1, CB2, CB3 CB3A, CB4, CB5	MERLIN GERIN	NSJ	600A	208-240V	100K
800A	CB1, CB2, CB3 CB3A, CB4, CB5	Square D	PJD	1000A	208-240V	100K



## 9 Introduction to Vertiv™ Liebert® STS2 / PDU Operation

### 9.1 System Description

A Liebert® STS2 / PDU provides an automatic, seamless transfer between input power sources to an output load. The Liebert® STS2 / PDU monitors the input sources, to ensure each source is operating within set parameters, as well as ensure that each source is within acceptable tolerances for a transfer between sources to be completed.

The Liebert® STS2 / PDU contains two static transfer switches in one enclosure to allow the unit to transfer its load between the two input sources without disruption to the output for longer than 1/4 of a cycle.

If a problem is detected with a primary (Preferred) input source and defined trigger points are reached, the Liebert® STS2 / PDU automatically switches the input to the other (Alternate) input source. The Liebert® STS2 / PDU continues to monitor both sources and can automatically transfer the load back to the preferred source, if so configured, when that source returns to acceptable operating parameters.

The system control logic automatically monitors the input sources and power output to ensure that they are operating within acceptable tolerances. The system logic manages the transfer between sources.

The Liebert® STS2 / PDU front panel contains a Color Graphical Display on an LCD touchscreen. The Color Graphical Display provides a menu-driven operator interface and a display of system information, status information, a one-line diagram (Mimic) of the Liebert® STS2 / PDU, active alarms and alarm history information.

The menu selections provide control of the preferred source, manual transfer initiation. Buttons provide for audible alarm silence and reset.

Through the touchscreen, specific voltage, current and environmental parameters can be configured to trigger events that can sound an alarm, write to a history log and either transfer sources or inhibit a transfer.

Preferred input source selection, alarm reset and alarm silencing are done through buttons on the touchscreen.

Communication options provide external communication with the Liebert® STS2 / PDU through a modem, a network card, a programmable relay board, a contact isolator or an RS-422 port to Vertiv™ Liebert® SiteScan™.

#### 9.1.1 Redundancy

Redundancy within the Liebert® STS2 / PDU prevents one component from being a single point of failure, should a problem occur. Redundant circuits and components are used to eliminate single points of failure.

Since the Liebert® STS2 / PDU has two input sources, no single component failure can cause a loss of power to the load. Redundant power supplies are provided which feed a DC dual-bus used throughout the unit to prevent any single-point power supply failure modes.

Three separate redundant control logic modules are built into the system. Each contains the logic necessary to run the Liebert® STS2 / PDU and control all transfers.

Redundant fans are provided if a primary fan fails. The redundant fans turn on to prevent overheating inside of the unit.

Should the front panel interface fail, the control logic continues to operate and the unit would transfer should a problem be detected on the preferred source. Information on the monitoring parameters would be available through the remote communication options, if available, or the DB9 (RS-232) connector located next to the LCD behind the front door. See **Figure 8.48** on page 76 for details.

## 9.1.2 Reliability and Agency Requirements

The Vertiv™ Liebert® STS2 / PDU is designed for high reliability and high availability with a critical bus Mean Time Between Failure (MTBF) exceeding 1,000,000 hours.

The Liebert® STS2 / PDU and all its options are designed, tested and certified, where applicable, to meet agency requirements as follows:

- UL 891: Standard for Switchboard, for UL and ULc listing
- UL 1008: Standard for Automatic Transfer Switches
- UL 67: Standard for Panelboard
- UL 1561: Standard for Dry Transformers
- UL 1459: Telephone equipment (Modem)
- NEC
- FCC Part 15 EMI emission limits for Class A computing devices.
- U.S. Department of Energy 2016

The Liebert® STS2 / PDU uses conservatively rated components, minimizing the need to go to maintenance bypass. All normal maintenance and repair work can be done through the front panel of the unit. This access makes repairs and maintenance easier.

Gating and control logic are partitioned so that failure of one source's gating or sensing logic does not prevent the switch from transferring to the other source.

All control and logic components are mounted separate from the power components. The Liebert® STS2/PDU™ is designed to minimize the exposure of hazardous voltages to allow safe servicing of the unit while the load is energized.

All electrical components requiring normal maintenance are replaceable without de-energizing the load, as long as one source is available. Solid-state switching devices are packaged to allow safe repair of those devices without having to de-energize the load. All non-automatic switches or circuit breakers are the plug-in or draw-out type to allow replacement without de-energizing the load. All other components, including transformers, power cables and connections, circuit breaker bases, etc., are replaceable from the front, rear or top of the unit—however, this requires all power to be removed from the unit for safety. All solid-state power switching devices are rated to prevent hazardous device failure in power systems with available fault currents up to the defined limits, as listed in [Electrical Requirements](#) on page 136 .

## 9.1.3 Factory Backup and Service Assistance

Because improper installation can cause a system to fail, a Vertiv or a factory-trained service technician should thoroughly inspect the unit to ensure it is properly installed and its operating parameters are properly configured.

Once the Liebert® STS2 / PDU is properly installed, you, as the on-site operator, can easily monitor the unit's operation utilizing the touchscreen.

In the United States, if you need assistance or have questions, call 1-800-543-2378). Outside the 48 contiguous United States, contact Vertiv, if available in your area.

For international areas not covered by Vertiv, the Vertiv authorized distributor can provide technical support.

## 9.2 Mode of Operations

### 9.2.1 Normal (Preferred Source)

Under normal operating conditions, the Vertiv™ Liebert® STS2 / PDU routes power from the preferred input source to the output load. The unit monitors the voltage, current and phase of each source to ensure that both are operating within set tolerances and that the alternate source is available, should a transfer be required.

### 9.2.2 Transfer

Should the preferred source fail or be outside acceptable voltage limits, the Liebert® STS2 / PDU transfers the input to the alternate source until the problem is rectified in the preferred source. The unit can be set to automatically transfer the input back to the preferred source or allow the transfer to be done only manually.

### 9.2.3 Transfer Inhibit

For a transfer to be completed between input sources, the sources must meet certain parameters or the transfer cannot take place. Uninterrupted transfer between sources is inhibited due to input source failure, sources out of sync, switch failure or the unit is in bypass mode.

### 9.2.4 Bypass

The Liebert® STS2 / PDU can be manually bypassed to allow the power from a source to directly flow to the output load. This bypass allows the unit's electronics to be serviced without dangerous voltages being present.

The Liebert® STS2 / PDU includes key-interlocked maintenance bypass breakers that allow either input source's electronics to be bypassed for maintenance without interruption of power to the load. The maintenance bypass allows all electronics to be isolated from the input, output and bypass connections. Bypass instructions are available from the touchscreen and are discussed later in this manual.

## 9.3 Operator Controls

The Liebert® STS2 / PDU is equipped with an interface to configure and monitor the unit either locally or remotely. The Color Graphical Display is a touchscreen LCD that provides a color diagram (Mimic) that displays the current status of the unit. System parameters are displayed and help is available to define events. See **Figure 9.1** on the next page and **Figure 8.50** on page 77. The touchscreen menus allow the operator to initiate source transfers, view event and history logs and view bypass and other operational instructions.

Figure 9.1 Vertiv™ Liebert® STS2 / PDU Touchscreen

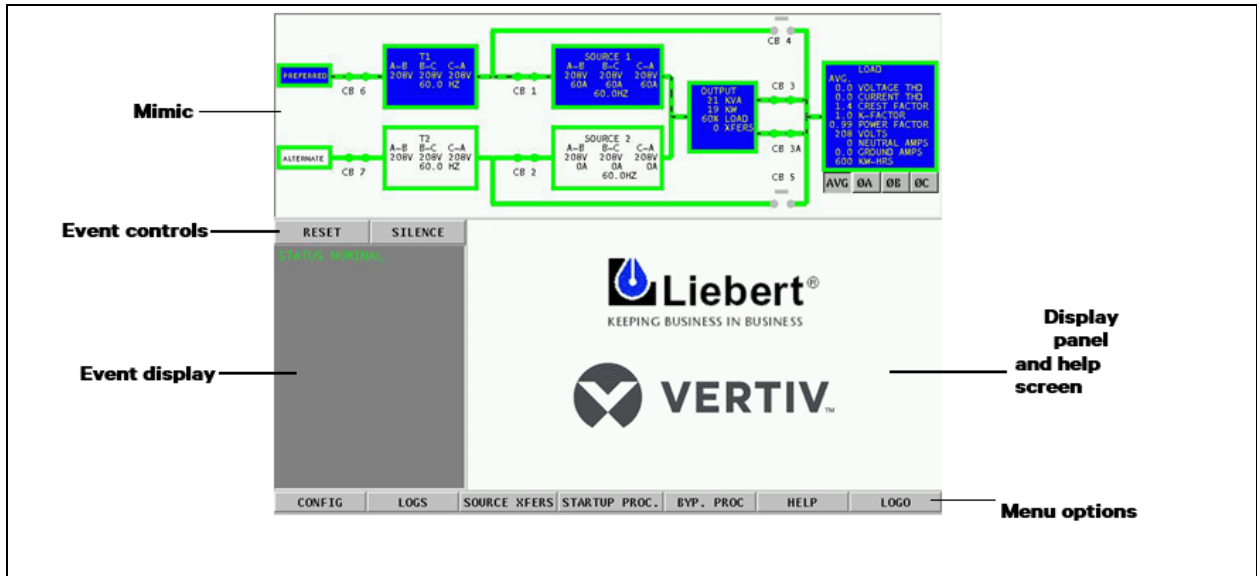

Touchscreen control buttons allow you to reset alarms, silence the audible alarm, review configurations, event and history logs, preferred source, startup and bypass procedures and the help menu.

Qualified personnel, with a password, can use these menus to configure parameters, select a preferred source and do manual source transfers.

Units can be accessed from a terminal or a PC running terminal emulation software attached to the unit. Through the RS-232 access, you can monitor and configure the unit, plus remotely select a preferred source. See [Using the RS-232 Port](#) on page 101 for instructions on using the RS-232 interface.

# 10 Theory of Operations

## 10.1 General Description

The Vertiv™ Liebert® STS2 / PDU contains all the equipment necessary to prevent an interruption in power flow to the AC load, should your primary source fail.

### 10.1.1 Liebert® Static Transfer Switch 2/Power Distribution Unit

The Liebert® STS2 / PDU is a combination automatic static transfer switch and power distribution unit. The Liebert® STS2 / PDU shall include two isolation transformers connected to a solid-state, three-pole, dual-position static transfer switch designed to automatically and manually switch between two synchronized three-phase AC power sources without an interruption of power to the load longer than 4 milliseconds (1/4 cycle). Input, output, bypass circuit breakers and a distribution section shall be included to form an integrated system in a single freestanding enclosure.

The preferred source is the input source that normally carries the load when both sources are available. The preferred source is selectable by the user from the LCD panel or an optional Remote Source Selection. The unselected source is referred to as the alternate source and carries the load if the preferred source should fail or if a manual transfer is initiated.

The unit uses Silicon Controlled Rectifiers (SCRs) connected in paralleled, opposing pairs to function as an AC switch configuration. Three pairs of SCRs connect the AC load to the selected preferred input source as long as the preferred source is available. A second set of SCRs stands ready to transfer the AC load to the alternate input source should the preferred source fail. The switching action is a very fast, break-before-make with less than a 1/4 cycle break in the AC waveform.

During static switch transfers and retransfers, the conduction state of the SCRs is carefully monitored and controlled to prevent a current path from one source to the other. This technique prevents a faulted source from feeding into the other good source.

### 10.1.2 Source Transfer

The Liebert® STS2 / PDU allows manually initiated transfers between the two sources, providing the alternate source is within acceptable voltage limits and phase tolerances with the preferred source. You begin a manual transfer by selecting the inactive source as the preferred source. On a manual transfer, the Liebert® STS2 / PDU transfers between the two sources with less than one (1) millisecond interruption of power to the load. The transfer can only be completed when both sources are available and synchronized within the user-adjustable phase synchronization window. For sources where the two frequencies are not exactly in phase, manually-initiated transfers are delayed by the Liebert® STS2 / PDU until the two sources are within the defined phase synchronization window.

Source selection can also be done remotely using the Remote Source Selection option, if installed.

### 10.1.3 Automatic Transfer/Retransfer

If the preferred source is out of voltage and/or frequency limits, the load is automatically transferred to the alternate source. The default transfer voltage limits comply with the limits of the IEEE Std. 446-1995 computer voltage tolerance envelope.

If the unit is so configured, the load is retransferred automatically to the preferred source after the preferred source returns to within the acceptable voltage and frequency limits for at least the defined retransfer time delay and is in phase with the alternate source. You can enable and disable automatic retransfer to the preferred source through a user configuration setting.

## Automatic Retransfer Inhibited

If the system makes five transfers from the preferred source to the alternate source in a five minute period, automatic retransfer back to the preferred source is disabled.

To clear this alarm condition, you must assign the alternate source as the preferred source. Also, the undervoltage detection thresholds may need adjustment. See [Source Setpoints](#) on page 118 for instructions on setting the UV detection.

This alarm also is cleared if the unit transfers to the preferred source due to an alternate source AC voltage failure (i.e., an emergency transfer.)

## 10.1.4 Emergency Transfer

To ensure that power remains connected to the load, the Vertiv™ Liebert® STS2 / PDU automatically performs an emergency transfer from one input source to the other when an outage occurs on the existing source.

The automatic transfer takes place if the other source's voltage is within acceptable limits and regardless of the phase difference between the two sources.

Emergency transfers occur with a loss of power on the output of less than 4 ms.

Emergency transfers from the alternate source to the preferred source are not affected by the Auto Retransfer Enabled/Disabled or Retransfer Delay user settings.

## 10.1.5 Load Current Transfer Inhibit

The Liebert® STS2 / PDU senses the load current. If the load current exceeds the preset level deemed to represent a load inrush or fault condition, the unit's logic disables manual and automatic transfers, even if the selected source's input voltage is outside the acceptable limits. This event triggers an I-Peak alarm. If so configured, the Load Current Transfer Inhibit is automatically reset after the current and voltage return to within normal parameters. This reset provides continued protection against a source failure. The Load Current Transfer Inhibit also can be programmed to require a manual reset. See step 14 for details.

## 10.1.6 SCR Failure

The Liebert® STS2 / PDU continuously monitors the status of the SCR switching devices for proper operation. In the event of a shorted SCR on the input source powering the load, the Liebert automatically triggers an alarm and trips open the other source isolation breaker. In the event of a shorted SCR on the other input source, the Liebert® STS2 / PDU automatically triggers an alarm and trips open the other source isolation breaker.

In the event of an open SCR, the switch automatically triggers an alarm and transfers the load to the other source. All open and shorted SCR alarm conditions are latched and require the system to be repaired and reset to restore normal operation.

## 10.1.7 On/Off Sequence

The Liebert® STS2 / PDU contains no master On/Off push button control. When connected to the input sources, the unit's logic power comes on automatically. The touchscreen is active as long as at least one input source is energized and the Control Power Disconnect (located inside the static switch) is closed.

## 10.2 Detailed Component Description

### 10.2.1 Controls

#### Operator Interface

The Vertiv™ Liebert® STS2 / PDU Color Graphical Display unit contains a color LCD touchscreen to provide the operator interface to control and configure the operation of the unit and quickly diagnose problems. A password and an optional keylock, if installed, are provided for security.

#### Hardware

- The Liebert® STS2 / PDU operator interface in the Color Graphical Display unit is designed to provide all of the information required to configure and monitor the unit's operation.
- The control logic performs automatic operations with minimal operator interface.
- Each Liebert® STS2 / PDU unit is equipped with a color LCD touchscreen.
- The Liebert® STS2 / PDU can have optional communication ports installed. [Options](#) on page 19 and [Communication Interfaces](#) on page 101 for more information on communication options.
- The RS-232 interface is used for configuration and status and event log monitoring.

#### Firmware

The operator interface enables you to monitor the Liebert® STS2 / PDU, to configure setpoints for transfers, monitor system parameters and access event and history logs. The firmware is accessible through the LCD touchscreen or the RS-232 interface. The firmware includes:

- View and set the preferred source.
- View and configure setpoints.
- View alarms, faults and status.
- The mimic graphical representation of the systems operation.
- Menu driven monitoring and configuration.
- Step-by-step instructions to assist you in the startup, shutdown and bypass operations.
- Help on event messages.
- Touchscreen alarm reset and silence buttons.

Events in the system, both faults and alarms, are detected and displayed on the LCD. See [Alarms and Faults](#) on page 95 for more information on events.

- A set of event masks can be configured through the LCD to trigger a system response to an event. See [Event Mask](#) on page 95.
- Report event conditions from other components of the system.
- Monitor and report changes in event condition states. If the event condition's state changes from inactive to active, a new event is detected. If the transition is from active to inactive, the event condition has cleared.
- Process new faults and alarms and clear inactive alarms.
- Provide the alarm reset and silence options.

## 10.2.2 Circuit Breakers and Non-Automatic Circuit Breakers

Input circuit breaker for each source provides over current protection for the Vertiv™ Liebert® STS2 / PDU. Three non-automatic circuit breakers provide total isolation of the solid-state switching devices with an input non-automatic breaker for each source and a load isolation non-automatic breaker. Two non-automatic breakers provide for maintenance bypassing of the solid-state switching devices to either input source.

All breakers in the Liebert® STS2 / PDU are plug-in types, which allows any breaker to be replaced without de-energizing the output bus. The breakers have an interlock in the plug-in base, which prevents the switch from being withdrawn in the CLOSED position. The switch trips OPEN before it disconnects from the plug-in base.

See [Circuit Breakers](#) on page 139 for specifications and more information pertaining to the circuit breakers. See **Figure 8.17** on page 48 through **Figure 8.30** on page 59 for circuit breaker locations.

The circuit breaker schedule is provided in **Table 8.5** on page 77 .

## 10.2.3 SCRs

Brick-type SCRs are used rated to carry the full 100% rated load. The unit is a fuseless design with input circuit breakers providing overcurrent protection.

## 10.2.4 Logic Modules

The logic contains three separate redundant logic modules. The modules contain the logic necessary to run the Liebert® STS2 / PDU and control transfers and shunt trips under all circumstances, without any outside assistance once set-up and started properly.

## 10.2.5 Audible Alarm

An audible alarm is installed on the control board. This alarm is triggered by an alarm condition detected on the unit. The alarm can be turned off from the touchscreen. Turning off the audible alarm does not clear or reset the condition that triggered the alarm.

## 10.2.6 RS-232 Port

An RS-232 serial port is provided to allow an external terminal to be connected as another user interface. See [Using the RS-232 Port](#) on page 101 for more information.



# 11 Operating Instructions

Before unit is placed into service for the first time, after equipment relocation or after the equipment has been de-energized for an extended period, a thorough equipment inspection and supervised startup by qualified personnel are strongly recommended. Contact your local Liebert representative or Vertiv at 800-543-2378 to arrange for equipment inspection and startup.

After the initial equipment startup, the following operating guidelines can be used for standard equipment operation. These guidelines should be reviewed for any special equipment modifications, special site conditions or company policies that may require changes to the standard equipment operation.

All programmable functions are preset at the factory to enable the unit to be brought up without the need to enter all selectable parameters.

The LCD touchscreen is discussed in more detail in [Touchscreen Display](#) on page 111 . See **Figure 8.17** on page 48 through **Figure 8.30** on page 59 for circuit breaker locations.

## 11.1 Normal System Turn-On

1. Depending on the type of distribution used:
  - If equipped with output breaker CB8, open CB8.
  - If equipped with output inline panelboards, open panelboard main breakers CB8 and CB9 and, if supplied, CB10 and CB11.
  - If optional subfeed breakers are supplied, open subfeed breakers CB12 and CB13. See **Figure 5.1** on page 12 through **Figure 5.4** on page 13 for location of breakers.
    - a. Retract the bolts on the key interlocks for CB1 and CB2.
    - b. Extend the bolts on the key interlocks for CB4 and CB5, thus preventing CB4 or CB5 from being turned ON.
2. Apply *source/input power* to both Vertiv™ Liebert® STS2 / PDU inputs by closing CB6 and CB7.  
The touchscreen control panel should become active and operate properly when at least one of the inputs is energized.
3. Verify that *nominal input voltages are applied to both inputs* (Source 1 and Source 2).  
The input voltages, selected preferred source, breaker and switch status and alarms are indicated on the Mimic screen.

Figure 11.1 Vertiv™ Liebert® STS2 / PDU Touchscreen

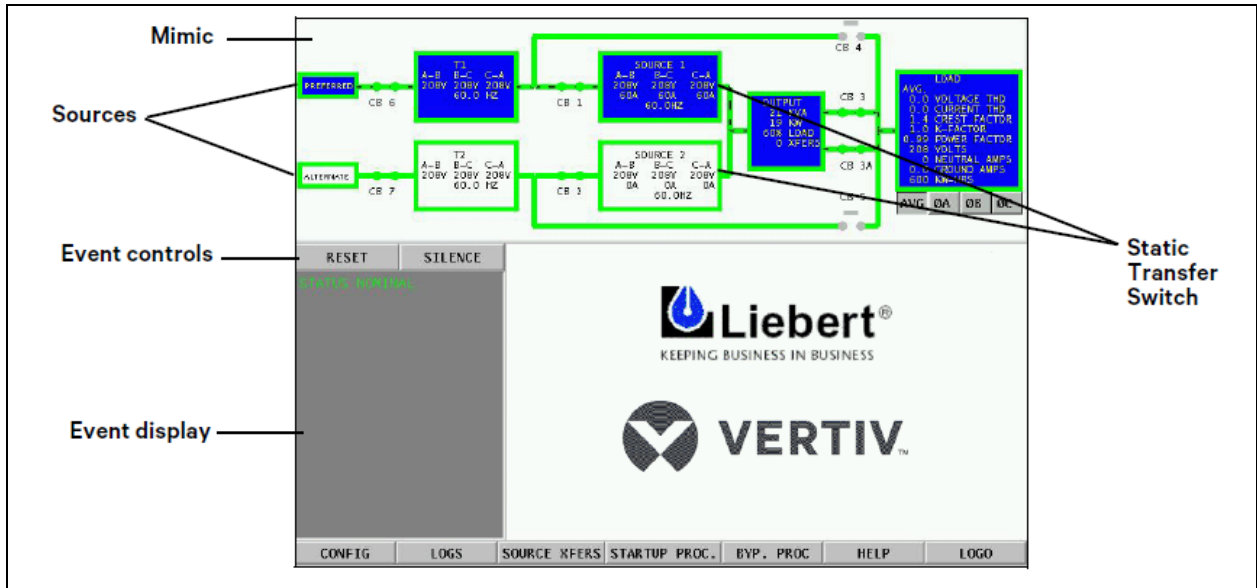

4. Close *CB1*.
5. Verify that *Source 1* voltages are nominal and that *CB1* breaker status is correctly indicated on the Monitor/Mimic screen.
6. Close *CB2*.
7. Verify that *Source 2* voltages are nominal and that *CB2* breaker status is correctly indicated on the Mimic screen.
8. Verify that boxes for the preferred source and corresponding Liebert® STS2 / PDU are highlighted on the Mimic screen, indicating which side of the Liebert® STS2/PDU™ is on.
9. Close *Output Breaker CB3* (for redundant output configurations, also close *CB3A*).
10. Verify that *CB3*, the *Output box* and the *Load box* are highlighted, indicating that *CB3* is closed and the STS output is energized. On units with I-line panelboard, the panelboard is also energized.

**NOTE:** For redundant output configurations, *CB3* descriptions apply to *CB3* and *CB3A*.

11. Press the *RESET* button on the touchscreen to reset any previous alarms.
12. Check the *Event Display* and the *Mimic* to verify there are no active alarms. If any active alarms are displayed, refer to 11.0 - ALARMS AND FAULTS for a description of the alarms and possible causes. Correct all active alarm conditions before proceeding.
13. If unit is equipped with output breaker *CB8*, close *CB8*. The output and load are energized.
14. If unit is equipped with output inline panelboards, close *panelboard main breakers CB8* and *CB9* and, if supplied, *CB10* and *CB11*. Turn on *panelboard breakers*. If optional subfeed breakers are supplied, close subfeed breakers *CB12* and *CB13*.
15. Turn on the *load equipment* as directed in the load equipment manufacturer’s recommendations.

## 11.2 Manual Transfer/ Preferred Source Selection

The Source Transfer option (Source Xfers) in the touchscreen menu allows you to select a preferred source. Transfers are only permitted when the voltage and current are within their proper operating range and the sources are synchronized. The Source Transfer screen indicates the synchronization between the two sources, while the voltage and frequency are displayed on the Mimic. See **Figure 11.2** below. Transfer is inhibited if the deviation exceeds the parameter set in Source Setpoints. See [User Settings](#) on page 117.

**NOTE: If one source will be de-energized for an extended period (hours or days), set the Vertiv™ Liebert® STS2 / PDU to bypass mode for the remaining source. Without using bypass, if a failure occurs in the switch components for the remaining source, the Liebert® STS2 / PDU does not have a second source to switch to and the load would not receive power. See [Maintenance Bypass](#) on page 140 bypass instructions.**

Figure 11.2 Source Transfer Screen

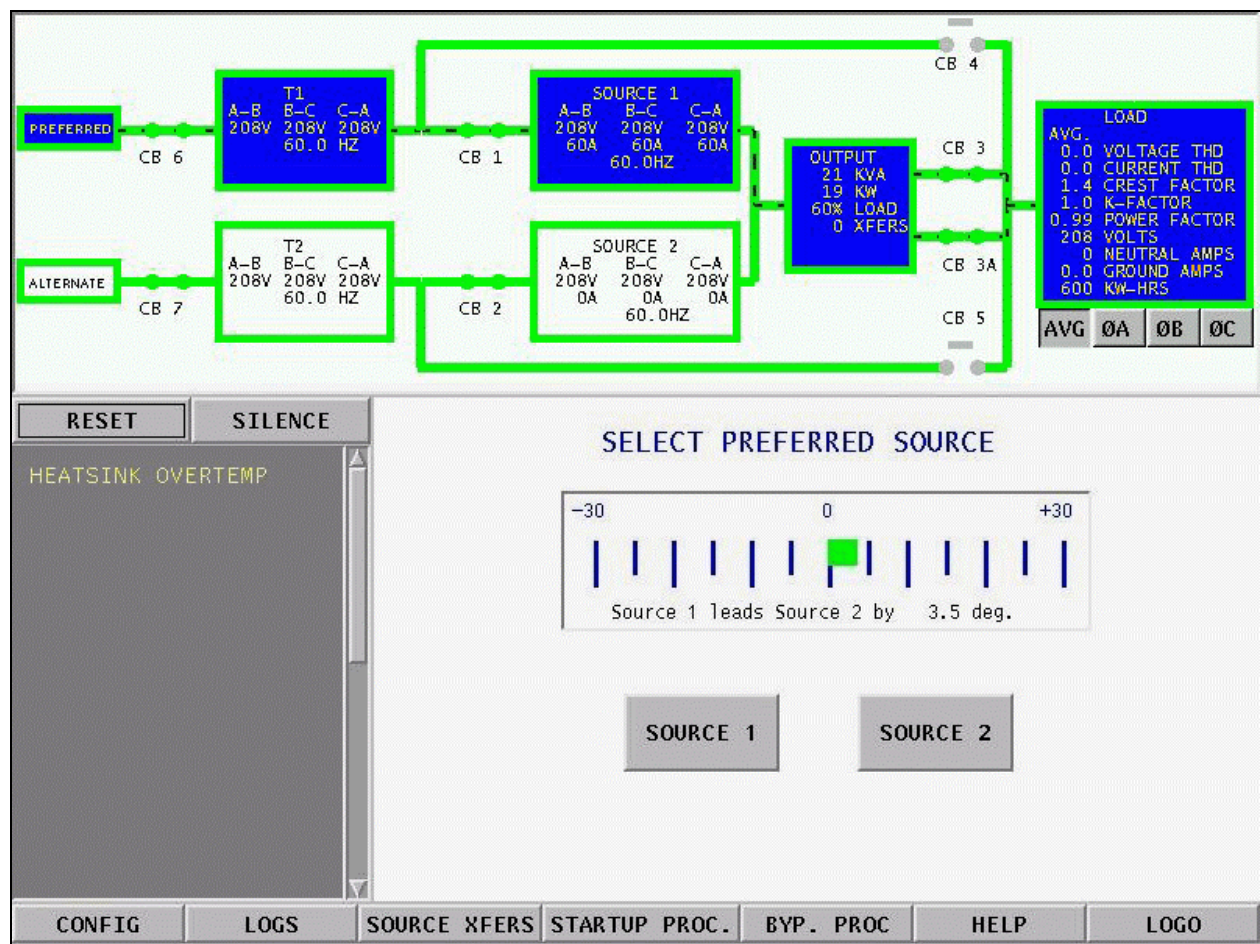

To manually select the preferred source:

1. Close the input breakers *CB6, CB7, CB1 and CB2*.
2. Select *SOURCE XFERS* from the menu bar.  
The Select Preferred Source screen is displayed in the Event Display.
3. Check the *Mimic* to verify that Source 1 and Source 2 input voltages are correct.
4. Select *SOURCE 1 or SOURCE 2* as your preferred source.  
This source is now monitored as the preferred source throughout the various configurations set up through the touchscreen.
5. Verify that the *correct source* is designated as the preferred source and that the input source changes to the desired source.

The Mimic is updated to indicate the new preferred source. The source is now highlighted with blue and that source is labeled as the preferred source. If the Transfer Inhibit message is displayed, check for alarm messages on the Active Status window. Correct alarm conditions before attempting a source transfer.

**NOTE: The preferred source may also be changed via the optional Remote Source Selection option, thereby initiating a transfer remotely.**

### 11.3 Enabling Remote Source Selection

If your system is equipped with the optional Remote Source Selection option, it must be enabled. From the Color Graphical Display:

1. Select *CONFIG* from the menu bar.
2. Select *SYSTEM SETTINGS* from the Configuration menu.
3. Select *SYSTEM OPTIONS* from the System Settings menu.
4. Select *YES* for the REMOTE SOURCE SELECT choice.

### 11.4 Maintenance Bypass

The Vertiv™ Liebert® STS2 / PDU is equipped with two key-interlocked, bypass breakers, CB4 and CB5, to allow manual bypass of the switch electronics for either input source in the event of switch failure or for maintenance of the switch. Refer to **Figure 5.1** on page 12. While operating on maintenance bypass, all voltages are removed from the static transfer switch electronics to facilitate safe repair, without de-energizing the load using a make-before-break switching sequence.

However, the unit can be bypassed using a make-before-break switching sequence only to the same source to which that the switch is connected, as indicated by the highlighted static transfer switch box on the Mimic screen.

In the event of source or switch failure, the unit should be bypassed only to the current input source. For convenience, instructions for the bypass procedure can be displayed on the touchscreen by selecting the *BYP. PROC* option from the menu bar.

The Mimic is used to verify the status of the unit during the bypass procedures. In the unlikely event that the Color Graphical Display is not available, open the front door and look through the slots in the control door. If you can see green LEDs on the gate driver board through that slot, then the unit is connected to the source referenced on the label below that slot. See **Figure 11.3** on the facing page.

Figure 11.3 Gate Board Viewing Slot Locations

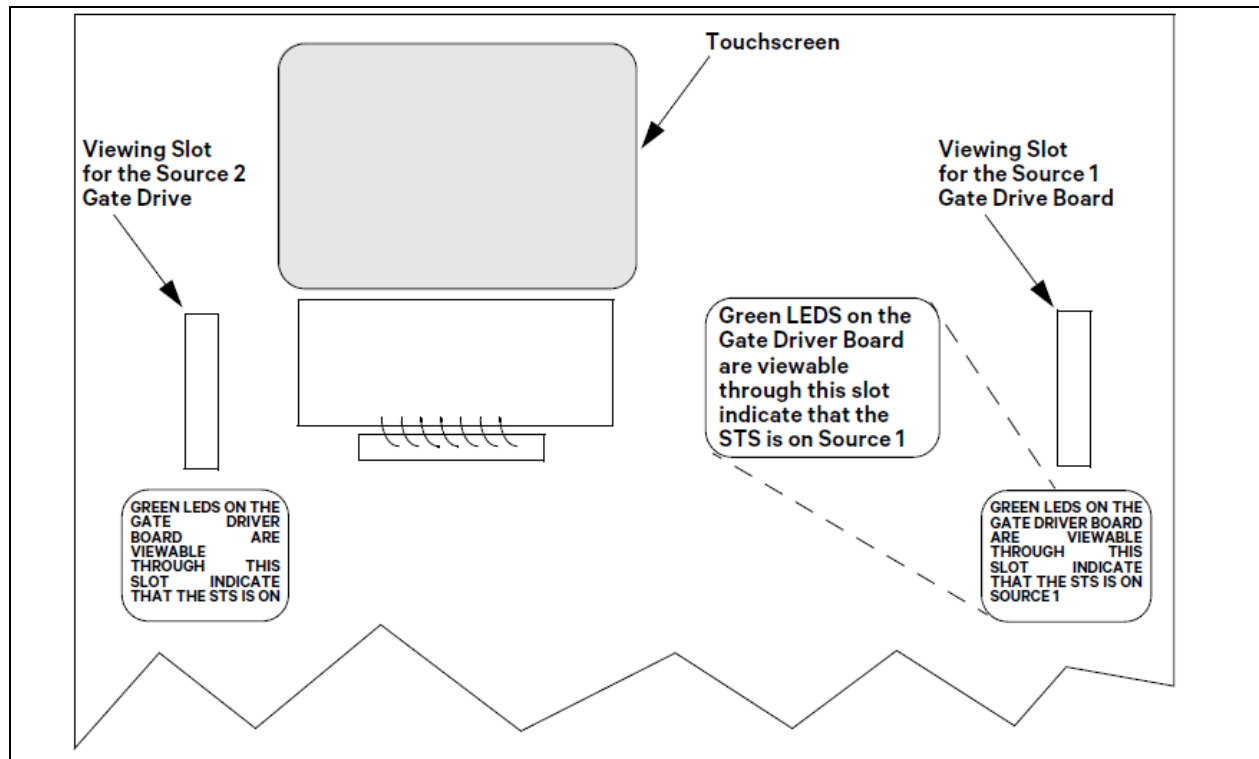

### 11.4.1 Bypass Procedures for Source 1

To bypass the switch for Source 1:

**NOTE:** If you wish to bypass the Source 1 static transfer switch but Source 2 is presently active, you must first transfer to Source 1. See [Manual Transfer/ Preferred Source Selection](#) on page 89 .

1. Verify *Source 1* is supplying power via the Mimic.
  - If the Color Graphical Display is not available, check the gate driver board LEDs through the slots in the control panel. See **Figure 11.3** above .
2. Remove *interlock* key from CB5 and place it in the CB4 interlock.
3. Open the *alternate source input breaker* CB2.
4. Rotate and remove the *CB2 interlock key*.
5. Insert the *key* in the CB4 bypass breaker interlock.
6. Rotate *interlock keys* in CB4 bypass breaker interlock to retract interlock.
7. Close *bypass breaker* CB4.
8. Verify the *breaker status* on the Mimic screen.
9. Open *source input breaker* CB1.
10. Rotate the *CB1 interlock key* and remove it to lockout the breaker.
11. Secure the *key*, per your site's lockout/tagout procedure.
12. Open *output breakers* CB3 and CB3A (if supplied) to remove power and isolate the static switch from the load.
13. Open *control fuses* F1-F4 to remove control power if necessary.

### To return to normal mode

1. Close *F1-F4* to apply control power
2. Remove the *key* from CB5 and insert it in the CB1 breaker interlock.
3. Rotate *key* to retract interlock.
4. Close *source input breaker CB1*.
5. Verify the *Source 1* and *CB1 breaker status* on the Mimic screen.
6. Select the *SOURCE 1 button* in the SOURCE XFERS menu.
7. Close *output breakers CB3 and CB3A* (if supplied).
8. Verify *CB3 and CB3A breaker status* on the Mimic screen.
9. Verify that *STS SOURCE 1* and *OUTPUT* boxes are highlighted on the Mimic screen.
10. Open *bypass breaker CB4*.
11. Rotate the *keys* in CB4 interlock to extend the interlock.
12. Remove the *proper key* from CB4 interlock and insert it into CB2 breaker interlock.
13. Rotate the *key* to retract the CB2 breaker interlock.
14. Close *source input breaker CB2*.
15. Verify the *STS SOURCE 2 box* and *CB2 breaker status* on the Mimic screen.
  - If the Color Graphical Display is not available, check the gate driver board LEDs through the slots in the control panel. See **Figure 11.3** on the previous page .

## 11.4.2 Bypass Procedures for Source 2

To bypass the switch for Source 2:

**NOTE: If you wish to bypass the Source 2 static transfer switch but Source 1 is presently active, you must first transfer to Source 2. See Manual Transfer/ Preferred Source Selection on page 89 .**

1. Verify *Source 2* is supplying power via the Mimic.
  - If the Color Graphical Display is not available, check the gate driver board LEDs through the slots in the control panel. See **Figure 11.3** on the previous page .
2. Remove the *interlock key* from CB4 and place it in CB5 interlock.
3. Open the *alternate source input breaker CB1*.
4. Rotate and remove the *CB1 interlock key*.
5. Insert the *key* in the CB5 bypass breaker interlock.
6. Rotate *interlock keys* in the CB5 bypass breaker interlock to retract the interlock.
7. Close *bypass breaker CB5*.
8. Verify the *breaker status* on the Mimic screen.
9. Open source input breaker *CB2*.
10. Rotate the *interlock key* and remove it to lockout the breaker.
11. Secure the *key*, per your site's lockout/tagout procedure.
12. Open *output breakers CB3 and CB3A* (if supplied) to remove power and isolate the static switch from the load.
13. Open *control fuses F1-F4* to remove control power if necessary.

**To return to normal mode:**

1. Close *F1-F4* to apply control power
2. Insert the *key* in the CB2 breaker interlock.
3. Rotate the *key* to retract the interlock.
4. Close *source input breaker CB2*.
5. Verify *Source 2* and *CB2 breaker* status on the Mimic screen.
6. Select the *SOURCE 2 button* in the SOURCE XFERS menu.
7. Close output breakers *CB3* and *CB3A* (if supplied).
8. Verify *CB3* and *CB3A* breaker status on the Mimic screen.
9. Verify that *STS SOURCE 2* and *OUTPUT boxes are highlighted* on the Mimic screen.
10. Open bypass breaker *CB5*.
11. Rotate the *keys* in CB5 interlock to extend the interlock.
12. Remove the *proper key* from CB5 interlock and insert it into CB1 breaker interlock.
13. Rotate the *key* to retract the CB1 breaker interlock.
14. Close source input breaker *CB1*.
15. Verify the *STS SOURCE 1* box and CB1 breaker status on the Mimic screen.
  - If the Color Graphical Display is not available, check the gate driver board LEDs through the slots in the control panel. See **Figure 11.3** on page 91.

## 11.5 Normal System Shutdown

The Vertiv™ Liebert® STS2 / PDU can be shut down from either the static switch mode or the bypass mode.

### 11.5.1 Shutdown in Static Transfer Switch Mode

When the Liebert® STS2 / PDU is operating on static transfer switch mode (not maintenance bypass mode):

1. Turn off the *load equipment* per manufacturer's recommendations.
2. Open *CB8* or *panelboard breakers* and *mains* if supplied
3. Open *CB3* to turn off the static switch output.
  - Open *CB3A* if the Liebert® STS2 / PDU has a redundant output configuration.
4. Open the input switches *CB1* and *CB2*.
5. To completely de-energize the unit, open *CB6* and *CB7*.

### 11.5.2 Shutdown in Maintenance Bypass Mode

When the Liebert® STS2 / PDU is operating on bypass:

1. Turn off the *load equipment* per manufacturer's recommendations.
2. Open *CB8* or *panelboard breakers* and main if supplied
3. Open the *bypass switch* (*CB4* or *CB5*) to turn off the static transfer switch output.
4. To completely de-energize the unit, turn open *CB6* and *CB7*.

This page intentionally left blank



## 12 Alarms and Faults

Alarms and faults are events that are triggered when the operation of the Vertiv™ Liebert® STS2 / PDU falls outside of the defined parameters. These events can also be triggered by: user actions, such as changing configurations, clearing logs, etc.; failed components such as a fan failure, an SCR that is open or shorted, etc.; and system status, such as open circuit breakers, load on alternate source, etc. These events can provide a warning or trigger the system to make a change, such as switch sources or the recording of a history log.

The Liebert® STS2 / PDU monitoring system detects and annunciates a comprehensive set of fault and alarm conditions. Faults and alarm messages are can be viewed on the LCD touchscreen or via the RS-232 port.

On the LCD touchscreen, the events are shown in the Status Display panel in the lower left corner of the touchscreen and written to the Event log. You can touch a message to view a definition of an event and a tip for troubleshooting. See [Touchscreen Display](#) on page 111 for more information about the touchscreen.

If you are monitoring the system through the RS-232 port, see **Table 13.1** on page 102 for the commands to view event logs and alarm and fault lists.

Event actions can be triggered by the settings configured from the Event Masks. See [Event Mask](#) below for more information.

**Faults** — A fault indicates that a component of the Liebert® STS2 / PDU has failed or has been damaged. In the Event Display, faults are indicated in red.

**Alarms** — An alarm is an event caused by a significant abnormal system condition. In the Event Display, alarms are indicated in yellow. The setpoints for many of the alarms are configurable through the User Settings. Many alarms clear themselves when the condition is resolved. If an alarm event mask is set to latch, the alarm messages remain active until the alarm condition has been corrected and the RESET button is pushed. See [Event Mask](#) below for more information on latching.

When the system is equipped with an external modem and a telephone line is connected to the modem, the system can be programmed to automatically dial out upon occurrence of any of certain designated alarms. The auto-dial feature can be configured for alarms using the Event Mask option in the touchscreen. See [Configuring the Modem](#) on page 123 for instructions on for setting up a modem.

### 12.1 Event Mask

The Liebert® STS2 / PDU gathers, processes and reports faults and alarms, collectively referred to below as events. The Event Mask dialog box allows you to set the system's response for specific alarms and faults that are generated.

The following mask types are available for each event:

- **Latch** — If a latch is enabled for the selected event, that event remains active even if the originating event condition clears. A latched event may only be cleared by pushing the RESET button.
- **Dial Out** — If the selected event is triggered, the system automatically calls the specified telephone numbers through a modem. For example, a page could be sent or an event could be sent to a external terminal, via a modem. See [Communication Interfaces](#) on page 101 for more information on configuring communications options.
- **Event Log** — The selected event is date/time stamped and recorded to the Event Log when the event is triggered.
- **Audible** — If the selected event is triggered, an audible beeper or horn is sounded by the Liebert® STS2 / PDU. The beeper continues while this event is active or latched or until the SILENCE button is pushed.

See [Event Masks](#) on page 116 for instructions on setting the mask type via the touchscreen. See the [Setting Event Masks with the Terminal](#) on page 109 for instructions on configuration using the RS-232 port.

## 12.2 Event and History Logs

The system tracks events through the Events Log and tracks significant events through the History Logs. These logs allow you to quickly spot trends or diagnose problems that the unit may have had. Both logs are written in nonvolatile memory.

The logs can be accessed from the touchscreen menu or the RS-232 port. See [Logs](#) on page 132 for more instructions on viewing the logs from the touchscreen. See **Table 13.1** on page 102 for the RS-232 interface commands used to access the logs.

### 12.2.1 Event Log

The events are tracked in sequence of occurrence. The sequence of occurrence is identified by date, time and frame number. The last 512 events are stored in a nonvolatile memory and can be viewed from the Event Log.

Event logs wrap, meaning when the log is full, the oldest event is deleted when a new event is written to the log.

The Event Log tracks:

- # — the sequence number in which the event occurred since the log was last cleared.
- Message — the event that occurred, such as Ambient Over temp., Source 1 Fail, etc.
- Type — either a Fault or Alarm. See [Alarms and Faults](#) on the previous page for further details on these events.
- ID — the event identifier.
- Date and Time — when the event occurred.
- Faults — the number of fault events logged.
- Alarms — the number of alarm events logged.
- User Alarms — the number of alarm events logged that were triggered by user-created alarms, such as those alarms created with the Input Contact Isolator settings.
- Total — the sum of all the events currently logged.

### 12.2.2 History Log

When a designated major alarm occurs, the History Status buffer is frozen, capturing 64 sequential frames before and after the alarm condition. When the History Status buffer is frozen, a History Log is created.

Two History Logs are available to track major alarms. This log includes the triggering event plus the surrounding events and the system voltages, currents, frequency, power, source selection and breaker positions at the time of the event. The History Log displays the 64 sequential frames, in 4-millisecond intervals, of the Present Status screens surrounding the event.

If you are viewing the log from the touchscreen, the Mimic and the Event Display show the data that was present as the alarm was triggered. The data is displayed as frames are played.

The History Log allows you to replay the events leading up to the alarm and the events right after the alarm to see the status of the switch at that time and diagnose the cause of the alarm. The History Log is triggered when certain events are tripped that have the Freeze option enabled.

You can run through the frames sequentially. The sequence of the events is identified by date, time and frame number. The History Log frames are stored in a nonvolatile memory buffer that is continuously overwritten until a designated fault condition occurs. When the fault occurs to trigger a freeze, the History Log stores the next 23 frames, then freezes until it is reset. The History Log then keeps 40 frames before the fault, the frame where the fault occurred, plus the next 23 frames.

The History Log should not be reset until the fault condition that caused the buffer to freeze is reviewed and investigated by a qualified service technician. After the alarm condition has been corrected, the History Log can be cleared.

The History Log has the following fields:

- **Replay Rate** — indicates how long it takes for the replay to play. Use the UP and DOWN buttons to set the time.
- **Status** — the status of the Vertiv™ Liebert® STS2 / PDU at the point of the current frame in the replay. The History log has three statuses: Frozen, Not Frozen and Retrieving Data, please stand by.
- **Critical Event** — The event which triggered this log to be written. The event is indicated in red on the bar graph.
- **Frame Number** — the current frame in the replay. A negative number indicates the replay is at a point before the triggering event occurred.

## 12.3 Alarm Notes

The I-PK on Source 1 and I-PK on Source 2 alarms inhibit automatic transfer due to an overload or load fault. These alarms can be set for either auto or manual alarm reset.

In the auto reset mode, the alarm is reset as soon as the load current and source voltage return to normal and the user manually presses the RESET button. In either case, the cause of the Source 1 or Source 2 Ipeak overload should be investigated and resolved (such as by reducing the overload condition or clearing the output fault) before returning the switch to normal operation.

These events indicate a device failure. The device must be replaced and the system must be restarted for the fault to clear. A shorted SCR automatically trips open a source input switch (CB1 or CB2) to prevent transfers in the event of an SCR failure. The SCR failure must be investigated and repaired before returning the switch to normal operation. Both source input switches must be opened (such as when the unit is placed in maintenance bypass for servicing) before a shorted or open SCR alarm can be reset.

## 12.4 List of Messages

12.4 above lists available event messages, a definition of the event and the functions that are activated with the event by default. The functions are indicated as follows:

- D — The indicated event initiates the Auto-Dial sequence through the optional modem. A — The indicated event activates the Audible alarm.
- F — The indicated event triggers a Freeze of the History Log.
- L — The indicated event Latches. A latched alarm remains displayed until the alarm condition has cleared and the RESET button has been pressed.
- E — By default, all faults and alarms are written to the Event Log. See [Setting Event Masks with the Terminal](#) on page 109 .

All of these functions, except Freeze, can be reconfigured to trigger for each event, using the Event Mask option. See [Event Mask](#) on page 95 . The Freeze function is hard-coded and cannot be changed for a event.

**Table 12.1 Event Messages**

ID	Alarm Message	Description/Cause	Action
1	S1 SCR SHORT	One or more of the SCRs for Source 1 have shorted and failed.	D, F, A, E
2	S2 SCR SHORT	One or more of the SCRs for Source 2 have shorted and failed.	D, F, A, E
3	S1 SCR OPEN	One or more of the SCRs for Source 1 is open.	D, F, A, E

**Table 12.1 Event Messages (continued)**

ID	Alarm Message	Description/Cause	Action
4	S2 SCR OPEN	One or more of the SCRs for Source 2 is open.	D, F, A, E
5	PRIMARY FAN FAIL	A primary cooling fan has failed and the unit is now being cooled by a secondary fan, which is not monitored.	D, A, E
6	CONTROL MODULE FAIL	Control logic module has failed.	D, A, E
7	PWR SPLY DC A FAIL	Power supply DC bus A has failed.	D, A, E
8	PWR SPLY DC B FAIL	Power supply DC bus B has failed.	D, A, E
9	PWR SPLY S1 AC FAIL	Power supply Source 1 AC has failed.	D, A, E
10	PWR SPLY S2 AC FAIL	Power supply Source 2 AC has failed.	D, A, E
11	PWR SPLY LOGIC FAIL	A power supply module has failed.	D, A, E
12	OUT VOLT SENSE FAIL	The output volt sense module failed	D, A, E
13	S1 VOLT SENSE FAIL	The Source 1 volt sense module failed.	D, A, E
14	S2 VOLT SENSE FAIL	The Source 2 volt sense module failed.	D, A, E
15	S1 SCR SENSE FAIL	The Source 1 SCR sense module failed.	D, A, E
16	S2 SCR SENSE FAIL	The Source 2 SCR sense module failed.	D, A, E
17	S1 CURR SENSE FAIL	The Source 1 SCR current module failed.	D, A, E
18	S2 CURR SENSE FAIL	The Source 2 SCR current module failed.	D, A, E
19	S1 GATE DRIVE FAIL	The Source 1 gate drive module failed.	D, A, E
20	S2 GATE DRIVE FAIL	The Source 2 gate drive module failed.	D, A, E
21	INTERNAL COMM FAIL	Internal CAN communications failed.	D, A, E
23	CB1 SHUNT TRIP FAIL	CB1 shunt trip failed.	D, A, E
24	CB2 SHUNT TRIP FAIL	CB2 shunt trip failed.	D, A, E
27	EQUIPMENT FAN FAIL	One of the equipment fans failed	D, A, E
28	INPUT 1 SURGE FAIL	Source 1 input surge suppression module failed	D, A, E
29	INPUT 2 SURGE FAIL	Source 2 input surge suppression module failed	D, A, E
64	HEATSINK OVERTEMP	Heatsink has exceeded the recommended temperature.	A, E
65	EQUIPMENT OVERTEMP	Cabinet has exceeded the recommended temperature	A, E
67	S1 UV	Source 1 under voltage, fast detection.	A, E
68	S1 UV (RMS)	Source 1 under voltage, slow detection.	A, E
69	S1 OV	Source 1 over voltage	A, E
70	S1 OF/UF	Source 1 over frequency/under frequency	A, E
71	S1 FAIL	Source 1 failure.	A, E
72	S2 UV	Source 2 under voltage, fast detection.	A, E
73	S2 UV (RMS)	Source 2 under voltage, slow detection.	A, E
74	S2 OV	Source 2 over voltage.	A, E

**Table 12.1 Event Messages (continued)**

ID	Alarm Message	Description/Cause	Action
75	S2 OF/UF	Source 2 over frequency/under frequency.	A, E
76	S2 FAIL	Source 2 failure.	A, E
77	S1 OVERCURRENT	Source 1 over current.	A, E
78	S2 OVERCURRENT	Source 2 over current.	A, E
79	S1 I-PEAK	I-PK on Source 1.	D, F, A, E
80	S2 I-PEAK	I-PK on Source 2.	D, F, A, E
81	SOURCES OUT OF SYNC	Source 1 and Source 2 are out of synchronization.	A, E
82	LOAD ON ALT SOURCE	The output load is running on the alternate source.	A, E
83	AUTO REXFER INHIBIT	Automatic retransfer is inhibited.	A, E
84	CB1 (S1) OPEN	Source 1, Circuit Breaker 1 is open.	A, E
85	CB2 (S2) OPEN	Source 2, Circuit Breaker 2 is open.	A, E
86	CB4 (S1 BYP) CLOSED	Source 1 on bypass, Circuit Breaker 4 is closed.	A, E
87	CB5 (S2 BYP) CLOSED	Source 2 on bypass, Circuit Breaker 5 is closed.	A, E
88	CB3 (OUTPUT) OPEN	Output circuit breaker (CB3) is open.	A, E
89	CB3A (OUTPUT) OPEN	Output circuit breaker (CB3A) is open.	A, E
90	S1 PHASE ROT ERROR	Source 1 phase rotation error.	A, E
91	S2 PHASE ROT ERROR	Source 2 phase rotation error.	A, E
92	TRANSFER INHIBITED	Transfer inhibited.	A, E
93	OUTPUT UV	Output is under voltage.	D, F, A, E
94	HISTORY LOG FULL	Both History Logs have been written and no more history logs can be written without clearing one of the logs	A, E
96	INPUT 1 OV INPUT	Source 1 over voltage	A, E
97	INPUT 1 UV INPUT	Source 1 under voltage	A, E
98	INPUT 2 OV INPUT	Source 2 over voltage	A, E
99	INPUT 2 UV INPUT	Source 2 under voltage	A, E
100	LOAD OVERCURRENT	Output over current	A, E
101	GROUND OVERCURRENT	Ground over current	A, E
102	NEUTRAL OVERCURRENT	Neutral over current	A, E
103	LOAD VOLTAGE THD	Voltage THD has exceeded the set limit	A, E
104	INPUT 1 CB6 OPEN	Source 1 input Circuit Breaker 6 is open	A, E
105	INPUT 2 CB7 OPEN	Source 2 Input Circuit Breaker 7 is open	A, E
106	INPUT 1 OF/UF	Source 1 over frequency/under frequency	A, E
107	INPUT 2 OF/UF	Source 2 over frequency/under frequency	A, E

**Table 12.1 Event Messages (continued)**

ID	Alarm Message	Description/Cause	Action
120	INPUT CONTACT #1	Input Contact # x is an optional alarm input. The alarm name can be programmed with an alarm name from the Input Contactor Isolator settings option under the Comm Options. See <a href="#">Configuring the Input Contact Isolator Settings</a> on page 125. The alarm is sent to Monitor DSP. The LCD logs the alarm with the programmed name. Monitor DSP logs it with the generic name which is how it is reported to the SVT query.	A, E
121	INPUT CONTACT #2		
122	INPUT CONTACT #3		
123	INPUT CONTACT #4		
124	INPUT CONTACT #5		
125	INPUT CONTACT #6		
126	INPUT CONTACT #7		
127	INPUT CONTACT #8		
128	CONFIG MODIFIED	A setpoint configuration has changed.	E
129	PASSWORD CHANGED	The password for touchscreen access has been modified and saved.	E
130	TIME REPROGRAMMED	The system's time has been reset and saved.	E
131	DATE REPROGRAMMED	The system's date has been reset and saved.	E
132	EVENT LOG CLEARED	The event log has been erased.	E
133	HIST LOGS CLEARED	Both History Logs have been erased.	E
134	XFER COUNT CLEARED	Transfer counter reset to 0	E
135	KWH COUNT CLEARED	KW-Hrs counter reset to 0	E

## 13 Communication Interfaces

The Vertiv™ Liebert® STS2 / PDU monitoring system offers several choices for communications.

The RS-232 terminal port is standard on all units. The port is inside the front door, to the left of the touchscreen front panel mounting as shown in **Figure 8.48** on page 76. This port is primarily used as an alternate user interface to configure, control and diagnose the system. Commands for the RS-232 port are shown in [Using the RS-232 Port](#) below.

Several other communications options are also available. Those options are located in a Communications compartment. See **Figure 8.41** on page 69 and **Figure 8.42** on page 70 for the location of the communications options.

Connections to the communication ports are made by wiring to terminal boards located in the Communications compartment. The communications options listed below reference the control wiring drawing for each option.

- Vertiv™ Liebert® IntelliSlot Unity Card (optional)** — the Liebert® Unity™ Card provides connectivity to any TCP/IP-based Ethernet network to allow the device to communicate with network management systems (NMS) via SNMP. Events can be transmitted to the NMS to provide remote status monitoring, plus fault and alarm detection. The Liebert® IntelliSlot Unity Card includes an RJ-45 port for an Ethernet connection, via Category 5 cable.

The Liebert® IntelliSlot Unity Card can also integrate the system with an existing Building Management System (BMS) or out-of-band monitoring, using Modbus, a standard multi-drop protocol. The card has redundant communication paths that make it possible to connect to a BMS using Modbus while simultaneously communicate to a NMS through SNMP.

See **Figure 8.47** on page 75 for more information on the Liebert® IntelliSlot Unity Card. If you have questions about the card, refer to the user guide, SL-52645, available at Vertiv's Web site, [www.vertiv.com](http://www.vertiv.com).
- Input Contact Isolator (ICI) Board (optional)** — provides an interface for up to eight user inputs. External messages and alarms can be routed to the unit, via the ICI. See [Configuring the Input Contact Isolator Settings](#) on page 125 for instructions on configuring the connections. See **Figure 8.45** on page 73 for wiring details.
- Programmable relay board (PRB) (optional)** — up to two PRBs can be installed in the Vertiv™ Liebert® STS2 / PDU to route Liebert® STS2 / PDU events to external devices. See [Configuring the Programmable Relay Board Settings](#) on page 127 for default settings and instructions for reconfiguring the relays. See **Figure 8.44** on page 72 for wiring details.
- Comms Board (optional)** — includes a terminal block to provide a DTE connection to an external modem. This board also provides a direct connection to a Vertiv™ Liebert® SiteScan™ terminal, via an RS-422.

Vertiv™ Liebert® SiteLink-12 or Vertiv™ Liebert® SiteLink-4™ is required for Liebert® SiteScan™ to communicate with the Liebert® STS2 / PDU. See **Figure 8.46** on page 74 for wiring details.

Data link requirements are Full Duplex Asynchronous RS-232 format. Communications options are also discussed in [Options](#) on page 19.

### 13.1 Using the RS-232 Port

The RS-232 port is configured with a baud rate of 9600 with 8 Data Bits, 1 Stop Bit, No Parity and no hardware handshaking.

### 13.1.1 Connecting and Using a Terminal

An RS-232 connection can be used to connect the Vertiv™ Liebert® STS2 / PDU to either a terminal or a PC running terminal emulation software. If unsure of the cable pin out, see [Terminal Port Connections](#) on page 139 .

1. Connect the *terminal* to the Liebert® STS2 / PDU by plugging the cable from the terminal into the RS-232 port. This connection can be made at any time.
2. After making the connection, verify the *communications link* by pressing <ENTER> on the terminal keyboard.

The interface communications system responds as indicated below:

- Repeating command --> Illegal command!
  - <?> or <HELP?> displays the RS-232 command set
  - <?> <command> or <HELP?> <command> displays specific help for the command SVTP-Control> The SVTP-Control > prompt indicates that RS-232 communications are established.
  - If you receive no response or prompt, verify that the connector is properly plugged into the port and the PC or terminal serial interface is working properly.
3. Enter the *desired commands*, as listed in **Table 13.1** below .

For additional help type <?> <command> or <HELP?> <command>

Refer to the corresponding menu options in [Touchscreen Display](#) on page 111 for more details about the commands.

Some terminal commands require a password. Use the PWD command and a valid password to gain access.

**Table 13.1 Terminal Commands**

Keys	Function
?	Displays this help menu or specific help with a command
AA?	Displays active alarms
AF?	Displays active faults
CEL	Clears the event log
CHL	Clears the history logs
DATE?	Displays current system date
DATE	Sets system date
EL?	Displays the entire event log
HELP?	Displays this help menu or specific help with a command
HLn?	Displays the history log #n, if frozen
LOGOUT	Logs user out of unprotected mode
PS?	Displays the preferred source
PS n	Sets the preferred source to #n
PWD	Allows users to access protected commands
QUIT	Modem only. Ends the session and hangs up the modem.
SH	Silences the horn
SPT?	Displays all current setpoints



**Table 13.1 Terminal Commands (continued)**

Keys	Function
SPTx	Displays current setpoints for group x. See 12.1.2 - Configuring the Vertiv™ Liebert® STS2/PDU™ via the Terminal for a description of groups.
SR?	Displays status reports
TIME?	Displays current system time
TIME	Sets system time
UPMDR?	Displays metering data
VER?	Displays firmware versions

### 13.1.2 Configuring the Vertiv™ Liebert® STS2 / PDU via the Terminal

The SPT command is used to configure the systems setpoints. The SVT syntax for the setpoints consists for four parameters:

SPT [group] [item] [value] where the parameters are:

- SPT — is the terminal command that is used to configure setpoints.
- group — the group under the setpoint command which contains the desired settings.
- item — the item number within the selected group.
- value — the desired value for this item.

Only the specific options words listed in this section use a hexadecimal value. Other settings, depending on what they are, use other input types. For example, System ID uses a text string; nominal voltages and currents use standard numeric integers; and modem baud rate uses an enumeration where

- 0 = 2400, 1 = 9600, & 2 = 19200 bps.

**NOTE: Spaces are placed between each parameter, but not between characters or numbers in a parameter. Using an underline here to represent a space, an example of a the syntax is: SPT\_2\_6\_0081. The value parameter is 0081.**

This section provides instructions for setting these parameters, with an example of building an SPT command for System and User settings.

#### Groups Parameter

The setpoints are grouped for ease of configuration. For example, Event Masks are group 4 and System Settings are group 2. The numbers shown below are entered for the group parameter. For example, start of a System Settings command is SPT 2.

The group parameters are:

- 1 = System Ratings
- 2 = System Settings
- 3 = User Settings
- 4 = Event Mask Settings

For example, the start of a System Settings command is SPT 2, where SPT is the system setpoints command and 2 is the group parameter for System Settings.

See [Setting Event Masks with the Terminal](#) on page 109 for instructions on configuring Event Mask parameters.

## Item Parameter

Each setting within the group is indexed by an item number as shown below in **Table 13.3** below. These item numbers are also displayed on the terminal when you list the configuration setting for a particular group.

Continuing with the example, to configure an Options\_1 setting under System Settings, the command would begin with SPT 2 6 where 6 is the value Options\_1. Note the space between each parameter.

## Value Parameter

Item settings, depending on what they are, use various value types. **Table 13.2** below provides a list of the possible value types and their description.

**Table 13.2 Value types**

Type	Definition
Numeric	An integer numeric value in the units indicated by the item name. For example, a System Voltage Rating of 480 would indicate 480 volts.
Scaled	Similar to the Numeric, this value type is an integer that has been scaled, usually to remove decimal points that would normally appear within the value. In this case, a value of 2.5 may actually be input as simply 25. For all Scaled types, the scaling appears in <b>Table 13.3</b> below.
String	Certain settings are represented by alphanumeric character strings, such as setting the System Model Number to ProductName.
Enumeration	This type uses an indexed list to represent possible choices. One example is the Modem Baud Rate which uses a value of 0 to select 2400 bps, 1 for 9600 bps and 2 for 19200 bps.
Bit-packed	This type of value uses a hexadecimal binary word, where each of the sixteen bits in the word has the value of 1 (True) or 0 (False). Although somewhat difficult to use, it packs a large amount of data within a single entry. A detailed description of this type appears in <a href="#">Setting Bitpacked Options With the Terminal</a> on page 106.
Event Masks	This type is a specially formatted and is used to customize the behavior of each fault and alarm in the system. See <a href="#">Setting Event Masks with the Terminal</a> on page 109 with the Terminal for instructions on configuring Event Mask parameters.

**Table 13.3** below shows the various groups, the settings contained within and the type of value it requires.

**Table 13.3 Group Settings and Values**

Group	Item:	Description	Value Type	Value Notes
Group 1: System Ratings	1	Input Volts (PDU)	Integer	Set per system spec.
	2	Volts	Integer	Set per system spec.
	3	Current	Integer	Set per system spec.
	4	Frequency	Scaled	Desired freq. x 10 (600 = 60 Hz)

**Table 13.3 Group Settings and Values (continued)**

Group	Item:	Description	Value Type	Value Notes
Group 2: System Settings	1	Language	Enumeration	[Not supported at this time]
	2	System Model Number	String	14 Character max.
	3	System ID Number	String	8 Character max.
	4	System Tag Number	String	8 Character max.
	5	System Order Number	String	8 Character max.
	6	Options_1	Bitpacked	14 Character max.
	7	Autodial Primary Line	String	20 Character max.
	8	Autodial Secondary Line	String	20 Character max.
	9	Autodial Pager Number	String	20 Character max.
	10	Autodial Pager PIN	String	10 Character max.
	11	Modem Init String	String	20 Character max.
	12	Modem Baud Rate	Enumeration	0 = 2400, 1 = 9600, & 2 = 19200 bps
	13	Modem LGS Check - Day	Bitpacked	
	14	Modem LGS Check - Time	Bitpacked	
	15	Comms Options 1	Bitpacked	See <a href="#">Setting Bitpacked Options With the Terminal</a> on the next page
	16	Comms Options 2	Bitpacked	See <a href="#">Setting Bitpacked Options With the Terminal</a> on the next page

**Table 13.3 Group Settings and Values (continued)**

Group	Item:	Description	Value Type	Value Notes
Group 3: User Settings	1	SRC1 Fast Undervoltage Setpoint	Integer	In % of nominal below nominal
	2	SRC1 Slow Undervoltage Setpoint	Integer	In % of nominal below nominal
	3	SRC1 Slow Undervoltage Detect Delay	Integer	In number of lines cycles
	4	SRC1 Overvoltage Setpoint	Integer	In % of nominal above nominal
	5	SRC1 Overvoltage Detect Delay	Integer	In 1/4 lines cycles
	6	SRC1 I peak Transfer Setpoint	Integer	x 10
	7	SRC2 Fast Undervoltage Setpoint	Integer	In % of nominal below nominal
	8	SRC2 Slow Undervoltage Setpoint	Integer	In % of nominal below nominal
	9	SRC2 Slow Undervoltage Detect Delay	Integer	In number of lines cycles
	10	SRC2 Overvoltage Setpoint	Integer	In % of nominal above nominal
	11	SRC2 Overvoltage Detect Delay	Integer	In 1/4 lines cycles
	12	SRC2 I peak Transfer Setpoint	Integer	x 10
	13	Max. Transfer Phase Angle	Integer	In degrees
	14	Output Frequency Deviation	Integer	Freq. in Hz x 10
	15	ReTransfer Delay Time	Integer	In seconds
	16	Horn Volume	Integer	Range: 1-10
	17	Critical Option Enabling	Bitpacked	See <a href="#">Setting Bitpacked Options With the Terminal</a> below
	18	Non-Critical Option Enabling	Bitpacked	See <a href="#">Setting Bitpacked Options With the Terminal</a> below
Group 4: Event Mask Settings	1 to 63	Event Mask settings for faults	Event Mask	See <a href="#">Setting Bitpacked Options With the Terminal</a> below .
	64 to 143	Event Mask settings for alarms	Event Mask	See <a href="#">Setting Bitpacked Options With the Terminal</a> below

### 13.1.3 Setting Bitpacked Options With the Terminal

Five sets of options and features settings are available through the terminal to control the system operation.

Under System Settings for the SPT command, these items denote which options are INSTALLED:

- 6 — Options\_1
- 14 — Comms Options 1
- 15 — Comms Options 2
- Under User Settings, for the SPT command, these items denote which features are ENABLED:
- 17 — Critical Option Enabling
- 18 — Non-Critical Option Enabling

The value parameter settings are in the form of a bit-packed word (in hexadecimal notation). In other words, each bit indicates a particular setting for the option or feature. The bit assignments for the options and features are as follows:

## Options\_1

- bit0 — HasDualOutputBreaker bit1 — HasPDU
- bit2 — Has4PoleTransferSwitch bit3 — HasShuntTrip
- bit4 — HasWyeOutputXfmr
- bit5 — HasExternalPrecisionTimeSource bit6 — HasSFA
- bit7 — HasRemoteSourceSelect
- bit8 through bit15 — not used (set to 0)
- Comms Options 1
- bit0 — HasIntModem bit1 — HasExtModem bit2 — HasNIC
- bit3 — not used (set to 0) bit4 — HasSiteScan
- bit5 — not used (set to 0) bit6 — not used (set to 0)
- bit7 — HasOpenCommsDigitalInputBrd bit8 — HasOpenCommsDigitalOutputBrd\_1 bit9 — HasOpenCommsDigitalOutputBrd\_2 bit10 — HasRemoteStatusPanelBrd\_1
- bit11 — not used (set to 0) bit12 — not used (set to 0) bit13 — not used (set to 0) bit14 — EnableDialIn
- bit15 — EnableDialOut

## Comms Options 2

- bit0 — EnablePager
- bit1 — EnableOCDINormallyClosed
- bit2-3 — OCDO1Assignment (0=User Defined, 1=Standard Set or 2=AS400)
- bit4-5 — OCDO2Assignment (0=User Defined, 1=Standard Set or 2=AS400)
- bit6 through bit15 — not used (set to 0)
- Critical Option Enabling
  - bit0—EnableManual\_IPeakReset
  - bit1—EnableAutoRestart
  - bit2 through bit15 - not used (set to 0)
- Non-Critical Option Enab
- bit0 — EnableAutoReXfer
- bit1 through bit15 — not used (set to 0)

The bits are set in reverse order, from bit 15 on the left to bit 0 (zero) on the right. The bits are grouped in four sets of four bits each, as such:

- 0000 0000 0000 0000
- |.....|
- bit 15. bit 0

Since each bit represents a setting, a bit can be enabled or disabled:

- 1 = installed option or enabled feature OR
- 0 = option not installed or feature not enabled

Enabling or disabling the bits in each group creates a binary value for that group. For example, if the fourth bit in a group is set to 1, the group's binary value is 0001.

Each group is translated into a hexadecimal equivalent. The group with the value of 0001 has a hex equivalent of 1.

You can use **Table 13.4** on the next page below to help with the conversion.

**Table 13.4 Binary-hexadecimal Conversions**

Binary Value	Hex Equivalent	Binary Value	Hex Equivalent
0000	0	1000	8
0001	1	1001	9
0010	2	1010	A
0011	3	1011	B
0100	4	1100	C
0101	5	1101	D
0110	6	1110	E
0111	7	1111	F

The hex value for each group is entered in the command as four digits. To summarize the procedure:

1. Set *each bit* position.
2. Convert the *binary value* each group into its hex equivalent.
3. Enter the *hex values* for each group, in order, into the command for the value parameter.

The following example explains how the conversion is completed.

### Putting the Terminal Command Together

For example, a unit only has the Remote Source Selection and Dual-Output Breaker options installed.

Checking the bits list under [Options\\_1](#) on the previous page, bits 7 and 0 each must be set to 1 to indicate that these options are installed.

The bit setting is as follows, starting with bit 15 on the left and going down to bit 0:

- 0000 0000 1000 0001

With the bits combined in groups of four, the binary settings can be translated into hexadecimal values.

The first two groups in the sample equal zero (0). In the third group, 1000 in binary translates to 8 in hex. In the fourth group, 0001 in binary translates to 1 in hex.

In hex, this equates to (digits in the value parameter cannot have spaces between them):

- 0081

So your command to indicate that the Remote Source Selection and the Dual-Output Breaker are installed would be:

- SPT 2 6 0081

### 13.1.4 Setting Event Masks with the Terminal

The event masks can be customized via a terminal. The command `SPT4?<ENTER>` displays all faults and alarms, along with their associated event masks. A plus sign (+) means that particular event mask is enabled, while a minus sign (-) means that mask is disabled.

Refer to [Event Mask](#) on page 95 for more information on event masks and their associated flags. Unlike the System and User Settings, mask values are set by designated letters, not hex values.

However, as with other RS-232 interface settings, four parameters are passed. See [Configuring the Vertiv™ Liebert® STS2 / PDU via the Terminal](#) on page 103 for more details about the parameters.

The syntax for configuring event masks is:

#### SPT 4 ID ±D±L±S±E±A

- SPT — is the terminal command used to configure setpoints.
- 4 — setting (group parameter) for event masks, under System Settings.
- ID — event ID. The ID is the item parameter for this command. The ID numbers for each event are listed with the events in Table 13.
- D,L,S,E,A — the event masks: Dial, Latch, Summary, Event log and Audible. The masks are the value parameter for the command.

Each mask type must be preceded by a plus sign (+) to enable it or by a minus sign (-) to disable it.

**NOTE: NO spaces are placed between each mask listed above.**

Only the mask that is passed (enabled) is applied when the event occurs. To set the event masks for a particular event:

1. Enter the *command*. Examples and descriptions are provided below.
2. Press *ENTER*.

After the new settings are entered, the new results for that event ID are displayed.

#### Examples of Event Mask Settings

- To latch event #001, S1 SCR SHORT, use `SPT 4 1 +L`.
- To disable event #128, CONFIG MODIFIED, from sounding the horn, use `SPT 4 100 -A`.
- To enable event #012, OUT VOLT SENSE FAIL, to Dial and go into the Event Log, use `SPT 4 12 +D+E`.
- To disable all masks for event #120, INPUT CONTACT #1, use `SPT 4 120 -D-L-S-E-A`.
- To breakdown this syntax for the last example:
- SPT — SVT command
- 4 — group parameter, identifying System Setting group under which the Event Mask settings reside.
- 120 — item parameter. In this command, that is the event ID.
- -D-L-S-E-A — value parameter. In this case, the minus sign (-) disables all masks for the INPUT CONTACT #1 event.

This page intentionally left blank



## 14 Touchscreen Display

The Vertiv™ Liebert® STS2 / PDU can be configured with a Color Graphical LCD touchscreen that allows you to quickly check the status of the unit and identify problems.

A touchscreen LCD is available through the front of the Liebert® STS2 / PDU. This screen provides a graphical (Mimic) display of the switch's operation, plus system information including system parameters, alarms and faults.

The LCD provides a color, back-lit touchscreen as a user interface. In addition to the Mimic and the system parameters, the screen provides a series of menus to allow you to configure the Liebert® STS2 / PDU, including the control of the preferred source, auto/manual retransfer selection, alarm notification and other system setpoints. The touchscreen also provides buttons to reset alarms and turn off audible alarms.

### 14.1 Display Overview

The Liebert® STS2 / PDU Color Graphical Display provides three areas of information, plus buttons and a series of menu choices.

The Color Graphical Display contains the following features:

- **Mimic** — a graphical diagram of the status of the unit.
- **Event controls** — allow you to reset alarms and turn off audible alarms.
- **Event display** — displays any active alarm or fault condition, in real-time.
- **Menus** — provide choices and configuration settings in dialog boxes or information in the display panel.
- **Display panel** — provides additional information, depending on the menu choice that was last selected. This information includes event help text and startup and bypass procedures.

Figure 14.1 Liebert® STS2 / PDU Touchscreen

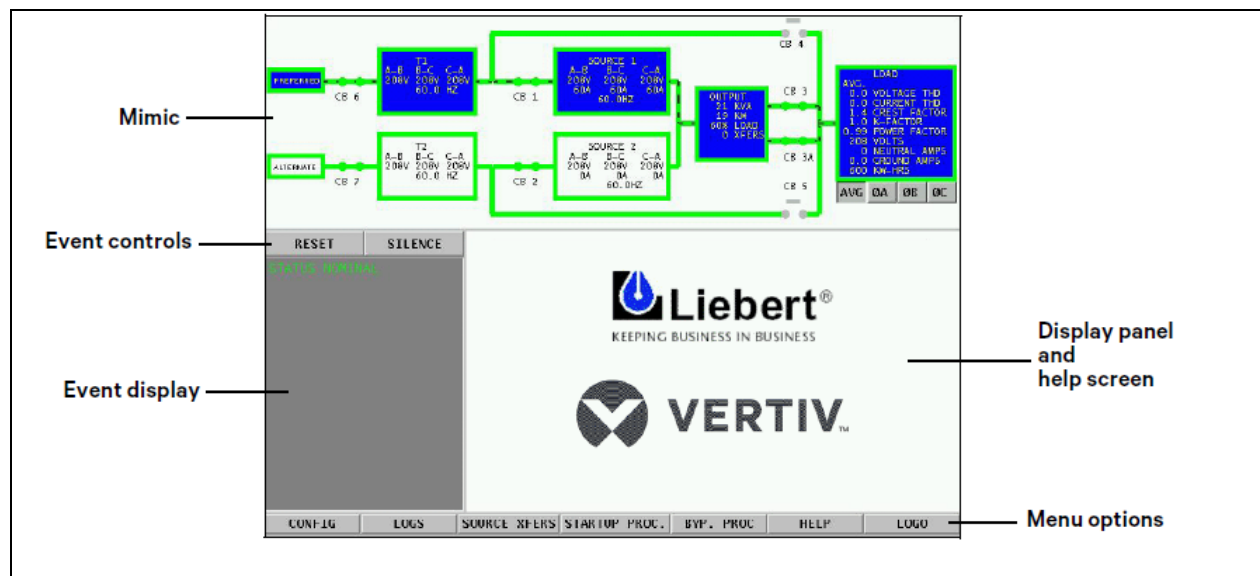

## 14.2 Menu Overview

The touchscreen menu provides access to configuration settings and more device information. The CONFIG (Configuration) and LOGS menus provide multiple choices through pop-up menus.

The SOURCE XFER menu selection allows you to select the preferred source. The other menu choices provide information in the display panel. The menu choices are discussed later in this manual.

All programmable functions are preset at the factory to default settings. These settings enable the unit to be brought up without the need to enter all selectable parameters. The menus allow the settings to be customized.

Figure 14.2 Menus

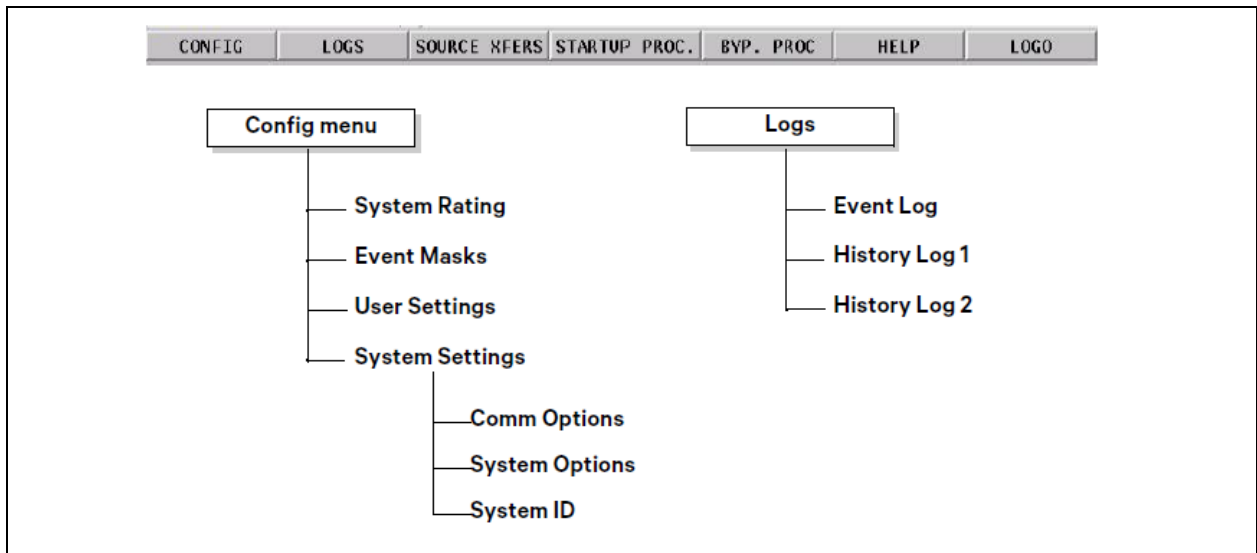

**NOTE:** Some menu choices display a keyboard or keypad on the touchscreen. Enter data on the touchscreen. Click OK to save the data that you have entered. Use the back arrow button (<-) to delete unwanted characters. This button functions like a backspace key on a keyboard.

Figure 14.3 Keyboard and Keypad Displays

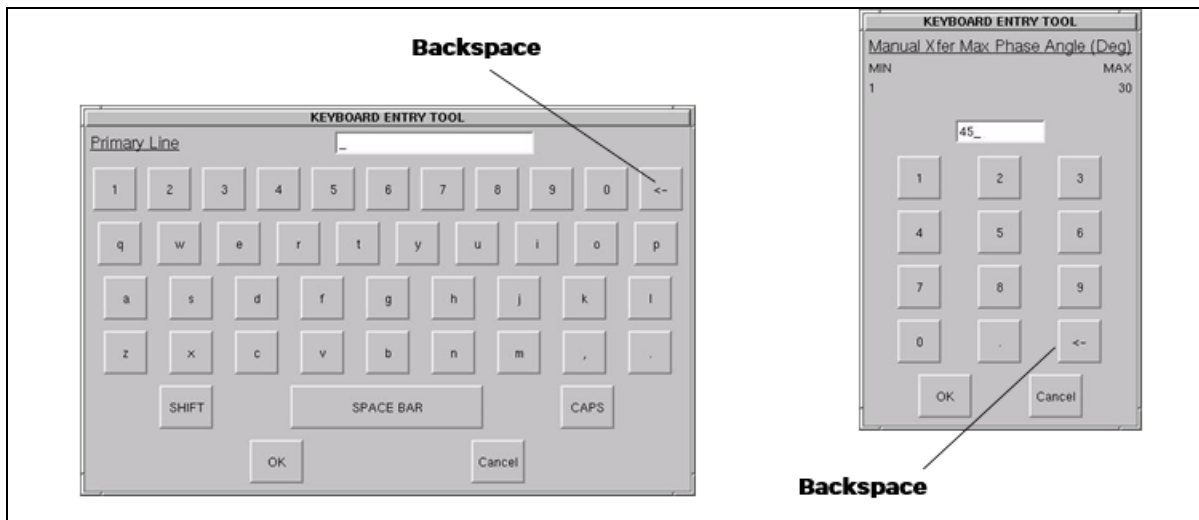

## 14.2.1 Security

Because the Vertiv™ Liebert® STS2 / PDU Color Graphical Display provides access to various configuration and monitoring choices, a password or key lockout switch may be used to protect access to certain changes, including:

- Change configuration settings
- Clear logs
- Make a source transfer
- Reset an alarm

Without entering the password or enabling changes with the key lockout switch, you still can:

- View the display, including the mimic, status and event help
- View logs
- View the startup and bypass procedures
- Use the SILENCE button to turn off the audible alarm

### Using the Optional Key Lockout Switch

An optional key lockout switch for the Liebert® STS2 / PDU enables or disables the ability to make changes on the Liebert® STS2 / PDU. The key lockout switch is located on the front of the unit next to the display; it is behind the front door but can be operated without opening the front door. See **Figure 8.14** on page 43 through **Figure 8.16** on page 47 for location of the key lockout switch.

- To disable the changes, turn the key to the top of the switch, toward the closed padlock.
- To enable changes turn the key to the horizontal position, toward the open padlock.

**Figure 14.4 Key Lockout Switch**

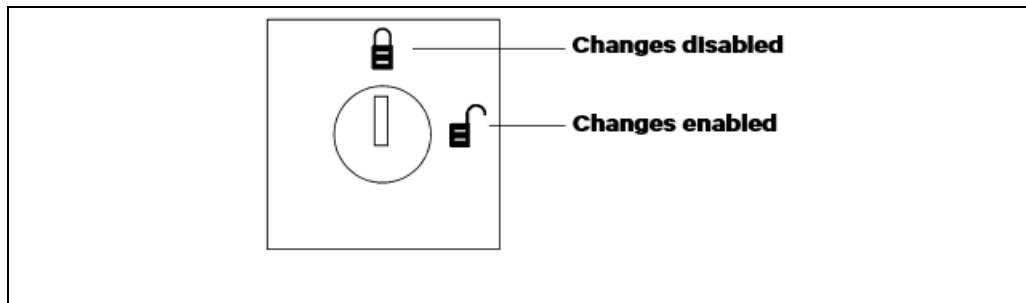

### Using the Password

If the unit is not equipped with a keylock, a password is required when you attempt to:

- Save changes in the CONFIG menu choices.
- Transfer sources.
- Reset active alarms.
- Clear logs.

When a password is requested, a keyboard is displayed on the touchscreen. After you enter the password, select *OK*.

The password is case-sensitive. Password access times out after ten (10) minutes and must be re-entered to save changes. The time-out period cannot be changed.

To set or reset the password:

1. Select *SYSTEM SETTINGS* from the CONFIG menu.
2. Select *SYSTEM ID* from the SYSTEM SETTINGS menu.
3. Click *PASSWORD*. A keyboard is displayed.
4. Enter a *password*. The password must be four (4) alpha-numeric characters and is case sensitive.
5. Click *OK*.

## 14.3 Mimic Display

The Mimic display provides a color diagram of the operation of the Vertiv™ Liebert® STS2 / PDU. This display imitates the power flow through the Liebert® STS2/PDU™ and indicates source status, breaker status, switch status, source voltage and current readings, output power measurements and active alarm messages. See **Figure 14.1** on page 111.

## 14.4 Event Controls

The Liebert® STS2 detects events when certain thresholds are passed or certain problems occur. The alarm controls allow you to acknowledge the existence of these events.

- **RESET** — All latched events whose conditions have cleared are removed from the Event Display. Faults and alarms that remain active or are not recoverable are not affected when this button is selected. This button is also used to perform manual I-Peak resets and manual retransfers.
- **SILENCE** — turns off the audible alarm (horn or beeper) without resetting the triggering event. This setting does not permanently turn off the horn. The alarm sounds again when the next event with an audible alarm setting is triggered.

Active events are shown in [Event Display](#) below, whereas cleared events can be reviewed via the [Event Log](#) on page 132.

## 14.5 Event Display

The Event Display lists the condition of the Liebert® STS2 / PDU in real-time. Both nominal system parameters and alarm messages are displayed in the Event Display. You can touch any message in the Event Display to display more information in the Display Panel to the left. The selected status is displayed in bold type.

## 14.6 Menu Bar

As previously mentioned, the menu bar provides both configuration choices and information. The choices under the Config and Log menus access additional dialog boxes, while the other menu choices only show information in the display panel.

## 14.7 Configuration Menu

When you select the CONFIG (Configuration) menu choice, a pop-up menu is displayed with four choices.

- **System Ratings**— used to configure frequency, voltage and currents settings for the Liebert® STS2 / PDU.
- **Event Mask** — allows you to configure system's response for events.
- **User Settings** — allows you to configure operations for the Liebert® STS2 / PDU.
- **System Settings** — accesses another pop-up menu to configure communication and system choices and the system ID.

Each of these choices accesses a separate dialog box.



### System Ratings

The System Ratings menu is used to set the nominal line frequency, nominal voltage and nominal current at which the system operates when it is installed. These settings are configured when the system is initialized at the factory or under maintenance and should not be changed by the user.

The "System Ratings" dialog box contains the following settings:

Parameter	Value
Line Frequency (Hz)	50 (selected) / 60
RMS Voltage	208
RMS Current	250
RMS Voltage (PDU)	208

Buttons: Save, Cancel

### Event Masks

The Vertiv™ Liebert® STS2 / PDU gathers, processes and reports faults and alarms, collectively referred to below as events. The Event Mask dialog box allows you to set the system’s response for specific alarms and faults that are generated. See [Alarms and Faults](#) on page 95 for more information on events and [Event Mask](#) on page 95 for the definitions of the Event Mask types.

To set the event masks:

1. Access the *Event Mask dialog box*:
  - Select *CONFIG*.
  - Select *EVENT MASK* from the pop-up menu.  
The Event Mask dialog box is displayed. See **Figure 14.5** below .
2. Select the *mask settings* for each fault and alarm.
  - Select *YES* to enable the setting, OR
  - Select *NO* to disable the setting.
3. Select *SAVE* to keep the settings.

**Figure 14.5 Event Mask Dialog Box**

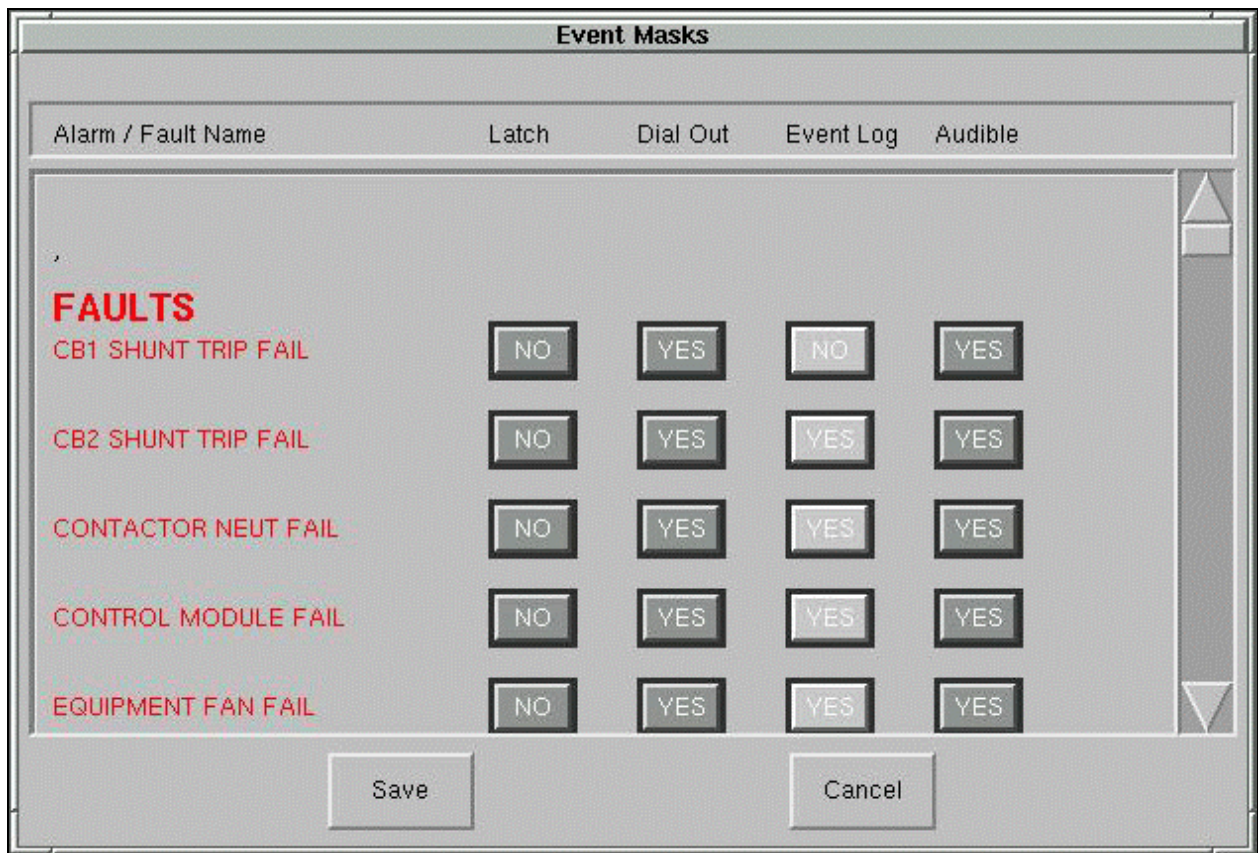

## User Settings

The User Settings choice allows you to adjust the user-accessible switch settings. Access is limited to qualified personnel via system security.

To access the User Settings dialog box:

1. Select *CONFIG*.
2. Select *USER SETTINGS* from the pop-up menu.  
The User Settings dialog box is displayed. See **Figure 14.6** below . The top six buttons access a series of secondary dialog boxes to configure the various settings.

**Figure 14.6 User Settings Dialog Box**

User Settings	
<input type="button" value="Source 1 / 2 Set Points"/>	
<input type="button" value="PDU Set Points"/>	
<input type="button" value="Manual Xfer Max Phase Angle (Deg)"/>	<input type="text" value="5"/>
<input type="button" value="Frequency Trip Point (Hz)"/>	<input type="text" value="0.5"/>
<input type="button" value="Retransfer Delay (Sec)"/>	<input type="text" value="3"/>
<input type="button" value="Audio Level"/>	<input type="text" value="5"/>
Display Brightness	<input type="button" value="HI"/> <input type="button" value="LO"/>
Auto Rexfer Enable	<input type="button" value="YES"/> <input type="button" value="NO"/>
Auto Restart Enable	<input type="button" value="YES"/> <input type="button" value="NO"/>
I-Peak Reset	<input type="button" value="AUTO"/> <input type="button" value="MAN"/>
<input type="button" value="Save"/> <input type="button" value="Cancel"/>	

## Source Setpoints

The Source 1/2 Setpoints allows you to configure trigger points for each input source (1 or 2) for the Vertiv™ Liebert® STS2 / PDU via a keypad dialog or HI/LO dialog box. The source numbers do not designate the source as the preferred or alternate source. The numbers simply identify the input source. See [Manual Transfer/ Preferred Source Selection](#) on page 89 to set the preferred source.

The Setpoints are based on values in relation to the nominal voltage required for the Liebert® STS2 / PDU. UV refers to under voltage, meaning the amount of voltage below the nominal voltage. OV refers to over voltage or the amount of voltage over the nominal voltage.

- **Fast UV Setting (%)** — if the voltage drops below this set percentage of the nominal voltage, the Liebert® STS2 / PDU transfers from the current source to the opposite source.
- **Slow UV Setting (%)** — if the voltage remains this set percentage below the nominal voltage for the period of the slow detection delay, the Liebert® STS2 / PDU transfers from the current source to the opposite source.
- **Slow UV detection delay** — the number of cycles that the source must remain below the Slow UV Setting before the Liebert® STS2 / PDU transfers.
- **OV Setting (%)** — if the voltage exceeds this set percentage of the nominal voltage for the period of the OV detection delay, the Liebert® STS2 / PDU transfers from the current source to the opposite source.
- **OV Detection Delay** — the number of cycles that the source must remain above the OV Setting before the Liebert® STS2 / PDU transfers sources.
- **I-PK Xfer Lockout** — if current from the source exceeds this threshold, the Liebert® STS2 / PDU disables source transfers and has to be reset either manually or automatically. The type of reset is configured under the User Settings.

To configure the setpoints for each source:

1. Select *SOURCE 1/2 SETPOINTS* from the User Settings dialog box. The Source 1/2 Setpoints dialog is displayed.



Figure 14.7 Source Setpoints

2. Select 1 to configure the settings for Source 1.
3. Configure the *settings* using the keypad or dialog box that is displayed when you touch a button.

Table 14.1 Setpoint Parameters

Button	Range	Default	Comments
Fast UV Setting (%)	-10 to -30% of Nominal voltage rating	-20%	Set in increments of 1%.
Slow UV Setting (%)	-5 to -20%	-10%	Set in increments of 1%.
Slow UV detection delay	1-60 cycles	5 cycles	Units: Line Cycle
OV Setting (%)	+5% to +20%	+10%	Set in increments of 1%.
OV Detection Delay	1-255 cycles	3 cycles	Units: 1/4 Line Cycle
I-PK Xfer Lockout	0 – 3.0 multiplied by the unit current rating.	1.5 Times Unit Current Rating	I-peak xfer lockout detection point. Units: Amps RMS. Select the HI or LO buttons to configure your setting.

4. Select 2 for Source 2.
5. Configure the *settings*, as described in step 3.

6. Select *SAVE* to keep the settings for both sources. The Setpoints dialog is closed and the User Settings dialog is displayed.
7. Select *MANUAL MAX XFER PHASE ANGLE*. A keypad is displayed.  
This setting configures the maximum allowed phase difference between the sources and applies to all manual transfers as well as any auto retransfer.
  - Configure this *setting* with a range of +/- 1-30 degrees. The default setting is +/-15 degrees and the resolution is 1 deg.
  - Select *OK* to save the setting. The setting is now displayed in the adjacent field in the User Settings dialog box.
8. Select *FREQUENCY TRIP POINT*. A keypad is displayed.  
This choice verifies that the source is running at the proper frequency. This choice sets the frequency deviation in the frequency that triggers the frequency trip point alarm. The frequency deviation setting is the allowable frequency variation from nominal (60 or 50 Hz) before activating the frequency deviation alarm. The frequency setting applies to both input sources.
  - Configure *this setting* with a range of 0.1 – 3.0 Hz. The default setting is 3 and the resolution is 0.1.
  - Select *OK* to save the setting.
9. Select *RETRANSFER DELAY*. A keypad is displayed.  
With the secondary source being used, this setting sets the length of time the switch waits until attempting to transfer back to the preferred source.
  - Configure *this setting* with a range of 1 to 60 seconds. The default setting is three (3) seconds and the resolution is 1 second.
  - Select *OK* to save the setting. The setting is now displayed in the adjacent field in the User Settings dialog box.
10. Select *AUDIO LEVEL*. A dialog box is displayed with HI and LO settings.  
This choice sets the loudness of the horn or beeper that is sounded for audible alarms.
  - Configure *this setting with a range of 1–10 (ten)*. The default setting is 5. The settings have an increment of 1 (one).
  - Select *OK* to save the setting. The setting is now displayed in the adjacent field in the User Settings dialog box.  
You can select *TEST* to briefly sound the alarm to judge its volume.
11. Select *DISPLAY BRIGHTNESS*. A dialog box is displayed with HI and LO settings. This choice sets the brightness for the touchscreen.
  - Configure the *Contrast and Brightness settings* with a range of 1 – 10 (ten).
  - Select *OK* to save the settings.
12. Set the *AUTO REXFER ENABLE* choice. The auto retransfer enable setting determines whether the switch automatically returns the preferred source after that source is restored.
  - Select *YES* to enable the automatic transfer.
  - Select *NO* to disable the automatic transfer. The setting requires transfers be done manually.
13. Set the *AUTO RESTART ENABLE* choice. This setting determines whether the Liebert® STS2 / PDU can be started automatically when power is restored after it has been lost.
  - Select *YES* to enable the automatic restart.
  - Select *NO* to disable the automatic restart. This settings requires a manual restart of the Vertiv™ Liebert® STS2 / PDU.  
To manually restart the Liebert® STS2 / PDU:
    - Select *SOURCE TRANSFER* from the MENU bar. The SELECT PREFERRED SOURCE window is displayed.
    - Select *Source 1 or Source 2* as your preferred source. The unit will restart.

14. Select a setting for the *I-PEAK RESET*.

- Select *AUTO* to configure the Vertiv™ Liebert® STS2 / PDU to automatically reset when a fault clears and the voltage and current are normal.
- Select *MAN* to require a manual reset of the Liebert® STS2 / PDU when fault clears and the voltage and current are normal.
- The default setting is Manual.



**CAUTION: Risk of equipment damage and personal injury.**

**Use of Auto Restart is site-specific. Do not enable auto restart unless the infrastructure is designed for unattended operation and there is no chance of equipment or personnel harm by automatic re-energizing of the system.**

**Consult with your Liebert site engineer as to whether Auto restart should be enabled.**

### PDU Setpoints

The PDU Setpoints option allows you to configure the following parameters for the PDU, shown in **Figure 14.8** below .

- Load Voltage THD (%)
- Neutral Current (% of nom)
- Ground Current (A)
- Load Bus Overcurrent (% of nom)

**Figure 14.8 PDU Setpoints**

Parameter	Value
Load Voltage THD (%)	15.0
Neutral Current (%)	95 % (237.5 A)
Ground Current (A)	5.0 A
Load Overcurrent (%)	101 % (252.5 A)

**Table 14.2** on the next page shows the range of valid values, default values and resolution for each parameter.

**Table 14.2 PDU Setpoints**

Button	Range	Default	Resolution
Load Voltage THD (%)	3.0% to 99.9%	15.0%	0.1
Neutral Current (% of nom)	10% to 200%	95%	1
Ground Current (A)	1.0A to 50.0A	5.0A	0.1
Load Bus Overcurrent (% of nom)	50% to 100%	100%	—

### System Settings

The System Settings choice under the Config menu displays another pop-up menu with three choices:

- Comm Options
- System Options
- System ID

To access the System Settings menu:

1. Select *CONFIG* from the menu bar.
2. Select *SYSTEM SETTINGS* from the Config menu.

### Comm Options

The Comm Options dialog box allows you to configure the communications settings for the Vertiv™ Liebert® STS2 / PDU.

- Select *COMM OPTIONS* from the System Settings Menu.
- The *Comm Options dialog box* is displayed. See **Figure 14.9** on the facing page .
- An option can be enabled by selecting *YES*.
- An option can be disabled by selecting *NO*.
- An option can be configured by selecting the adjacent option button to display a separate configuration dialog box.

The instructions for configuring the communications options are provided in this section.

Figure 14.9 Comm Options Dialog Box

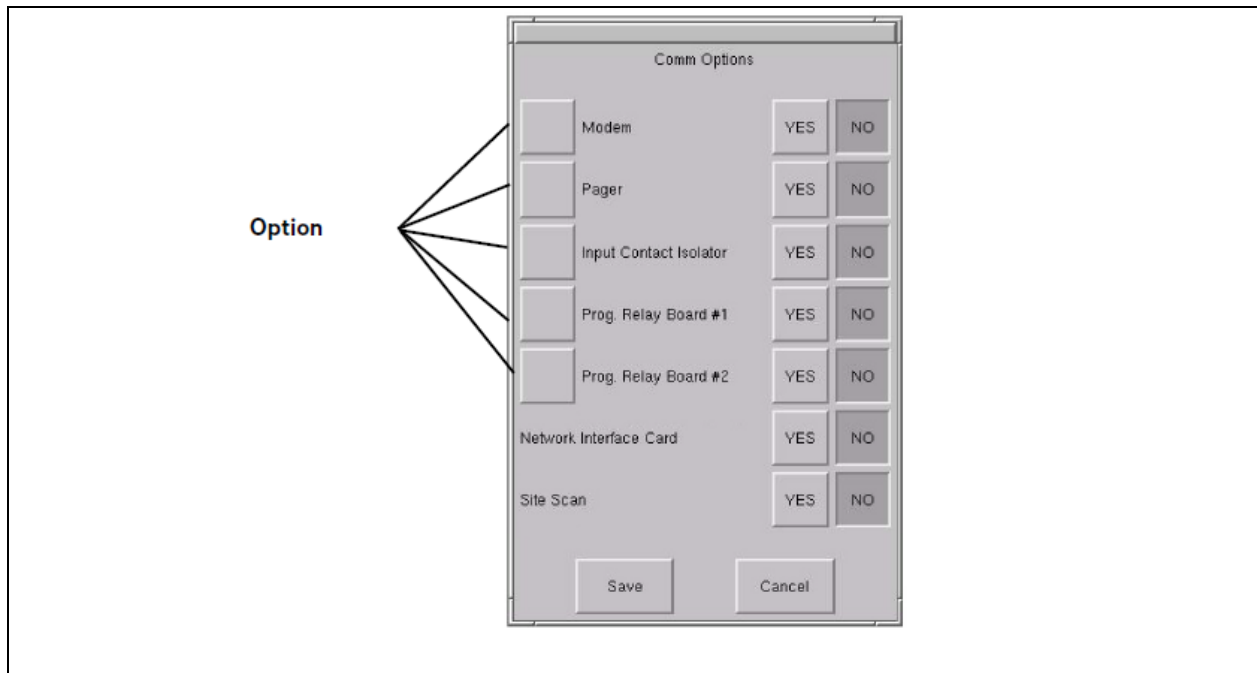

### Configuring the Modem

The Modem dialog box allows configuring an external modem connected to the Vertiv™ Liebert® STS2 / PDU.

The dialog box contains a series of choices that access either a keypad or a secondary dialog to configure settings. Auto dial can also be configured for the modem to be triggered by events, as set up in the Event Mask choices.

Designated major alarms activate the auto dial modem sequence. Automatic dial attempts are made to the first number three times, at 30 seconds between attempts. If connection is not established in that time period, the system automatically rolls over to the second number. Auto dial attempts are made again three more times at 30 seconds between attempts. The process is repeated until a successful connection is made. Upon successful connection, the system transmits a present status data, including all active alarms messages. After transmission, the modem automatically hangs up and returns to the auto-answer mode.

To configure the modem:

1. Select *MODEM* from the Comm Options menu. The Modem dialog box is displayed.

Figure 14.10 Modem Dialog Box

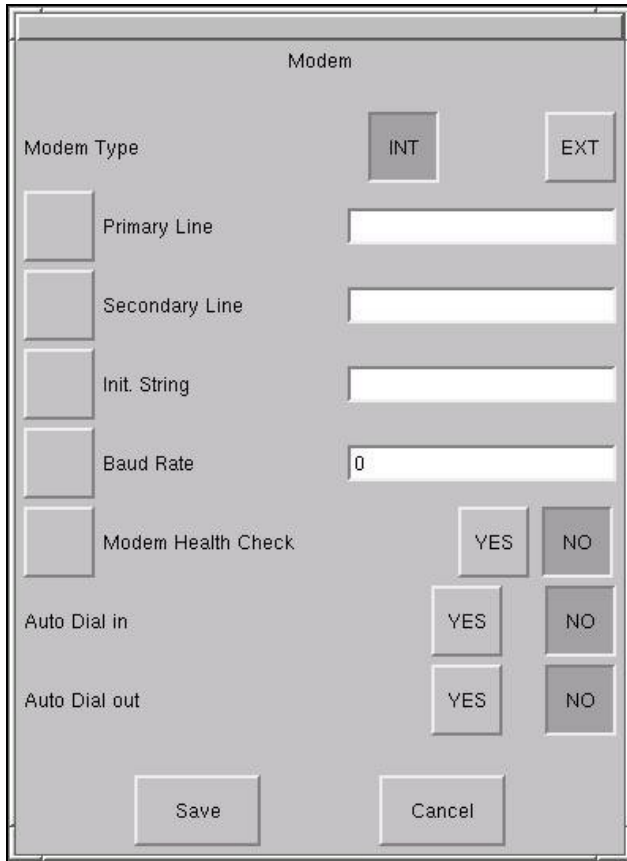

2. Select the type of modem that the Vertiv™ Liebert® STS2 / PDU will be using:
  - Select *INT* internal modem not available.
  - Select *EXT* if the Liebert® STS2 / PDU will be communicating via an external modem.
3. Select the *PRIMARY LINE* choice to enter the primary telephone number for the modem to dial when an alarm is triggered.
4. Enter the *number* in the keypad dialog box.
5. Select *OK* to save the telephone number. The number is displayed in the field adjacent to the Primary Line choice.
6. Select the *SECONDARY LINE* choice to enter the secondary telephone number for the modem to dial when an alarm is triggered.
7. Enter the *number* in the keypad dialog box.
8. Select *OK* to save the telephone number. The number is displayed in the field adjacent to the Secondary Line choice.
9. Select *INIT. STRING* to configure the initialization string. This string configures the parameters of the modem. Check your modem's documentation for this setting.
10. Select *BAUD RATE* to display a dialog with the baud rate choices:
  - For an external modem, select from 2400 bps, 9600 bps or 19200 bps.
11. Configure the *MODEM HEALTH CHECK*. The Health Check verifies that the modem is working properly. This setting allows you to enable the check and set when it is run.
  - Select the *button* to display the Modem Health Check dialog box, from which you can access further dialogs to set the time and days that the check is run.

- Select *SAVE* to keep the settings.  
The Health Check dialog box is closed and the Modem dialog box is again active.
  - Select *YES* in the Modem dialog box to activate the Modem Health Check. If you select *NO*, the Modem Health Check is not run.
12. Configure *AUTO DIAL IN*. Auto Dial In allows a user to dial into the Vertiv™ Liebert® STS2 / PDU through the modem to check status and access the system via a hyperterminal connection.
    - Select *YES* to activate the dial in feature.
    - Select *NO* to deactivate the dial in feature.
  13. Configure *AUTO DIAL OUT*. Auto Dial Out allows the Liebert® STS2 / PDU to automatically dial out to a system to notify a user of an event or status.
    - Select *YES* to activate the dial out feature.
    - Select *NO* to deactivate the dial out feature.
  14. Select *SAVE* to keep the modem configuration settings.
  15. Select *YES* in the Comm Options dialog box to activate the settings. You are returned to the Comm Options dialog box.

### Configuring the Input Contact Isolator Settings

The Input Contact Isolator (ICI) is an optional, eight-channel input board for up to eight external user alarm or message inputs to be routed to the Liebert® STS2 / PDU alarm network.

The contact is set to either be normally open or normally closed. When a contact closes or opens, an event is triggered. See [Input Contact Isolator Board](#) on page 20 for more information on the ICI.

The Input Contact Isolator options are configured through the Input Contact Isolator dialog box, which is accessed from the Comm Options dialog box. The Input Contact Isolator dialog box contains eight choices to match the eight channel input board. You can label each button to identify the event associated with the contact. When the dialog box is accessed, each button flashes to display the Input Contact Isolator number and the user entered label. This label also appears in the Display Panel when an event related to an Input Isolator Connector is triggered.

The Input Contact Isolator dialog box allows you to:

- Label the input contact assignments for your setup.
- Set the delay for an external event triggering an alarm.
- Review the isolator contact assignments, once the labels are entered.

The delay allows you to set the number of seconds which a condition needs to persist to trigger an alarm.

These input alarms can also be configured to activate a programmable relay output, which is discussed in [Configuring the Programmable Relay Board Settings](#) on page 127 .

To configure the Input Contact Isolator relays:

1. Select *INPUT CONTACT ISOLATOR* from the Comm Options menu. The Input Contact Isolator dialog box is displayed.

Figure 14.11 Input Contact Isolator Dialog Box

INPUT CONTACT #	DELAY	0.0
INPUT CONTACT #1	DELAY	0.0
INPUT CONTACT #2	DELAY	0.0
INPUT CONTACT #3	DELAY	0.0
INPUT CONTACT #4	DELAY	0.0
INPUT CONTACT #5	DELAY	0.0
INPUT CONTACT #6	DELAY	0.0
INPUT CONTACT #7	DELAY	0.0
INPUT CONTACT #8	DELAY	0.0

Save Cancel

2. Select *INPUT CONTACT 1*.  
A keyboard is displayed to allow you to enter the name of the alarm.
3. Enter the *name of the alarm* set for that input. For example, a fan problem could be indicated by naming the button FAN.
4. Select *OK* on the keyboard to keep your label.
5. Select *DELAY*.  
A keypad is displayed prompting you for a delay time, in seconds, for a condition to exist before the alarm is triggered.
6. Enter the *delay value*. The range for the values are from 0 (zero) to 99.9 seconds.
7. Select *OK* on the keypad to keep your setting.  
The value you entered is displayed in the field adjacent to the corresponding input contact.
8. Repeat Steps 2 to 7 for each input contact.
9. Select *SAVE* after you have configured all input contacts.  
Be sure to select *Save* even if you have accessed this dialog only to change a setting.



10. Enter the *settings* in **Table 18.2** on page 170 - Input contact isolator settings record. This information is not saved if control power is removed.
11. Select *OK* in the Comm Options dialog box to activate the settings.

### Configuring the Programmable Relay Board Settings

The Vertiv™ Liebert® STS2 / PDU can contain up to two programmable relay boards (PRB) that can trigger an external device when an event occurs in the Liebert® STS2 / PDU. For example, if Source 1 fails, an external light flashes.

See [Programmable Relay Board](#) on page 19 or more information on the PRBs.

The programmable relay board dialog box with two options: STANDARD SET and USER DEFINED SET. The STANDARD SET are the factory-configured settings.

The STANDARD SET for the programmable relay board settings are:

**Table 14.3 Standard settings for Programmable Relays**

Relay	Setting	Definition
1	SOURCE 1 FAIL	Source 1 failure
2	SOURCE 2 FAIL	Source 2 failure
3	BYPASS CB4 CLOSED	Switch (CB4) is closed; Source 1 is bypassed.
4	BYPASS CB5 CLOSED	Switch (CB5) is closed; Source 2 is bypassed.
5	TRANSFER INHIBIT	A transfer between Source 1 and Source 2 is being restrained.
6	OUT OF SYNC	The phase difference between sources 1 and 2 exceeds the allowable threshold for transfer.
7	EQUIP OVER TEMP	The ambient temperature of the ProductName exceeds the recommended threshold for operation.
8	Blank	No setting

The USER DEFINED SET allows you to assign faults and alarms to each contact on the relay boards.

Utilizing the USER DEFINED SET, you can also select Input Contact Isolators to associate with a programmable relay.

In addition individual events, three other assignment choices are available:

- SELECT ALL sends a summary event to the selected relay whenever any event occurs. If this setting is selected for a relay, no other event needs to be assigned for that relay.
- ON SOURCE 1 or ON SOURCE 2 can be assigned to a relay to send a notification when that source is being used by the load.

Once configured, the Liebert® STS2 / PDU continuously checks the status of the items defined for each contact and updates the state of the relay.

To configure your programmable relay boards for user defined settings:

1. Select PROG. RELAY BOARD # x from the Comm Options dialog box, where x is the corresponding board number.  
The Programmable Relay Board dialog box is displayed.

Figure 14.12 Programmable Relay Board Dialog Box

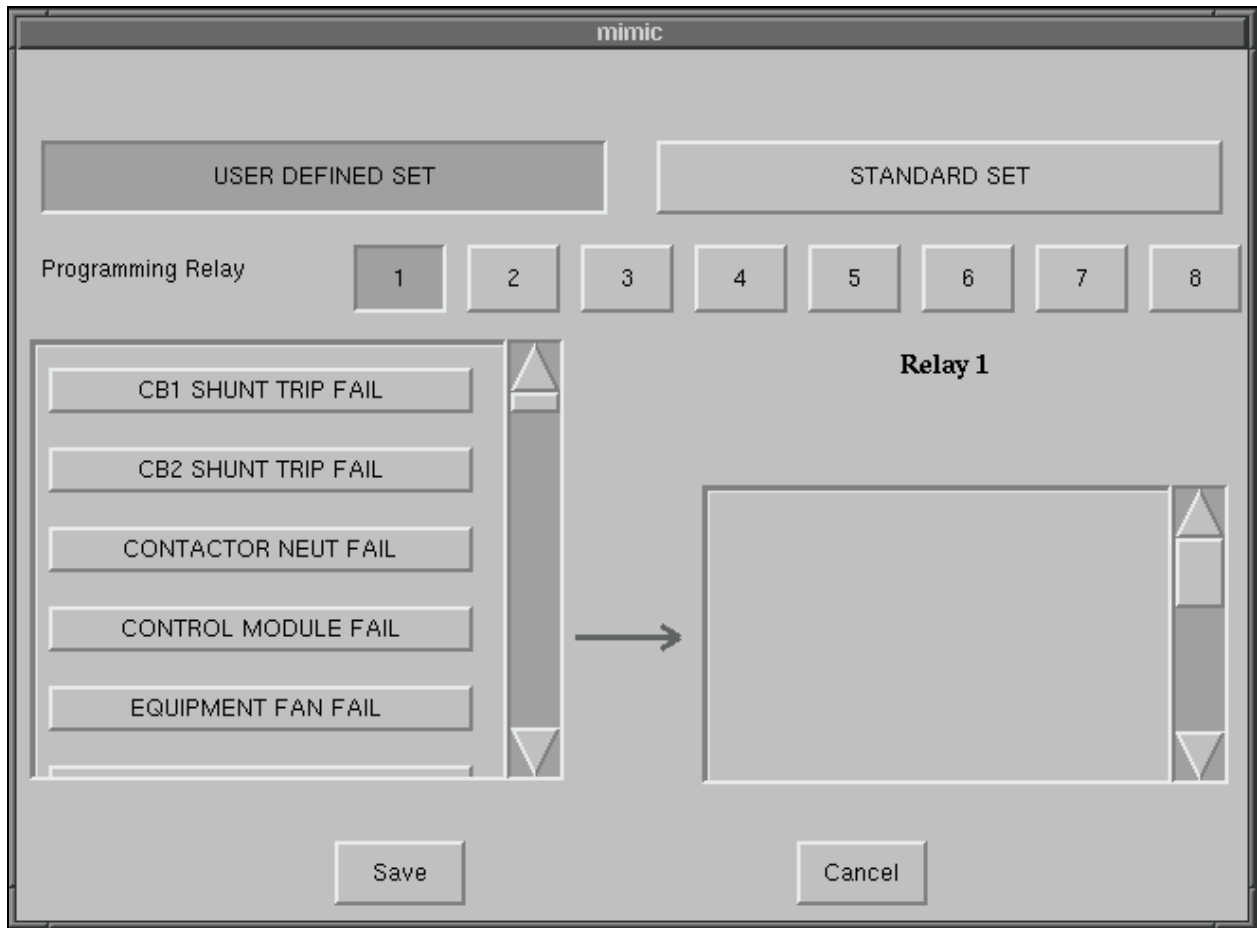

2. Select your *configuration settings*.
  - Select *STANDARD SET* to use the settings configured at the factory. See Go to step 4 .
  - Select *USER DEFINED SET* to configure your own settings. Go to step 3 .  
If you enter a user-defined setting, record the setting in **Table 18.1** on page 169 . If the control board is replaced, it will be necessary to reprogram the Programmable Relay Board with this information.
3. To define your relay board settings:
  - Select a *Programming Relay*.
  - Select an *event* you want associated with the relay. That fault is placed in the Relay column.  
You can associate up to ten (10) events with one relay. If you do so, you should group the events logically to simplify troubleshooting when an event is triggered.
4. Select *SAVE* to keep the settings.
5. Select *OK* for the applicable Programmable Options Board option in the Comm Options dialog box to activate the settings.

### Configuring the Vertiv™ Liebert® IntelliSlot™ Unity™ Card

A Liebert® IntelliSlot™ Unity™ Card (IS-UNITY-DP) can be installed in the Vertiv™ Liebert® STS2 / PDU to provide Ethernet connectivity via an RJ-45 port.

Ethernet cabling is the responsibility of the customer. Category 5 cabling is required.

See [Vertiv™ Liebert® IntelliSlot Unity Card](#) on page 21 for more information on the card. See the Liebert® IntelliSlot™ Unity™ Card installation and user guide for configuration instructions for the card.

If the optional Liebert® IntelliSlot™ Unity™ Card is installed in the Liebert® STS2 / PDU:

- Select **YES** for the Network Interface Card option in the Comm Options dialog box to activate the card.

### Vertiv™ Liebert® SiteScan™ Configuration

An RS-422 port on the optional Comms Board provides communications with Liebert® SiteScan™. Liebert® SiteScan™ is Liebert's system-monitoring software that allows utilizing a PC to monitor the Liebert® STS2 / PDU status and check alarms. See [Comms Board](#) on page 20 for more information on this board.

If the Liebert® STS2 / PDU will be connected to Liebert® SiteScan™:

- Select **YES** for the Liebert's® SiteScan® choice in the Comm Options dialog box to activate the card.

### Saving Your Communications Configurations

To save you communications configuration settings:

1. When you have completed the Comm Options configurations, ensure you have selected **YES** for all the settings that you want activated.
2. Select **SAVE** to keep the settings.  
Whenever you make modifications to the any of the Comm Options, select **SAVE** to keep the changes.

### System Options

Most system options are configured at the factory. However, you may need to set two of the choices after the unit is installed: Wye Output Transformer and Remote Source Selection.

- Select **SYSTEM OPTIONS** from the System Settings Menu. The System Options dialog box is displayed.
- An option is enabled by selecting **YES**.
- An option is disabled by selecting **NO**.

Figure 14.13 System Options

Option	YES	NO
Dual Output Breaker	YES	NO
<input type="checkbox"/> PDU	YES	NO
4 Pole Transfer Switch	YES	NO
Shunt Trip	YES	NO
Wye Output Transformer	YES	NO
Remote Source Select	YES	NO

Save Cancel

### Dual Output Breaker

This selection is set at the factory. The choice is set to YES to enable both output breakers (CB3 and CB3A) when two are installed in the unit. If only one output breaker (CB3) is installed, the setting is set to NO.

### PDU

This selection is set at the factory to YES, which allows the LCD to draw the Mimic accordingly and display PDU metering and alarm information.

Select the PDU button in the System Options window (see **Figure 14.13** above). This opens the PDU Options window, shown below in **Figure 14.14** on the facing page.

Figure 14.14 PDU Options Button

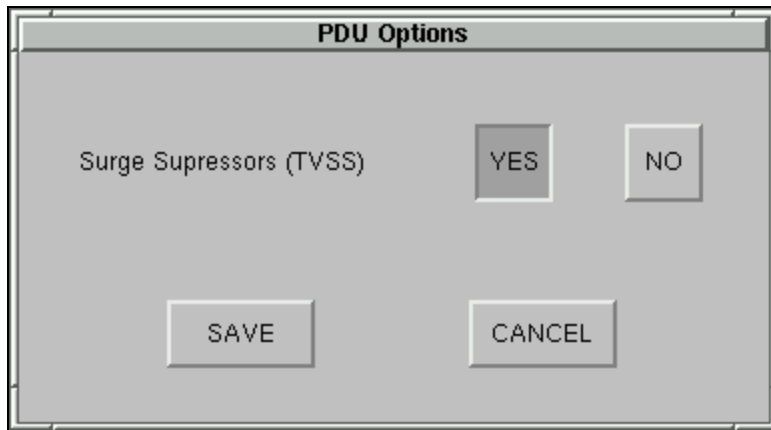

The PDU Options window allows you to specify whether you have the surge suppression option.

- If the TVSS option is installed, this selection is set at the factory to YES. To disable surge suppression, click NO.
- Click SAVE.

#### 4 Pole Transfer Switch

This selection is set at the factory to indicate whether the system is a 3 pole or 4 pole unit. The 4 pole design is not available at this time.

#### Shunt Trip

This selection is set at the factory.

#### Wye Output Transformer

The Wye Output Transformer controls the firing of the SCRs on startup, which minimizes the inrush into PDU transformers. Output breakers and PDU input breakers have to be closed when you start up the system. Based on whether the input side of the PDU transformer is configured as a Wye or Delta changes the firing sequence of the SCRs.

If the Vertiv™ Liebert® STS2 / PDU is connected to a PDU configured as a Wye:

- Select YES for the Wye Output Transformer choice in the System Options dialog box.

#### Remote Source Select

If your system is configured with the optional Remote Source Selection, it must be enabled from the System Options menu. See [Remote Source Selection Wiring](#) on page 14 for more information.

If the system is utilizing Remote Source Selection:

- Select YES for the Remote Source Select choice in the System Options dialog box to activate the option.

#### System ID

Most of the settings for System ID are set by Liebert either at the factory or when the unit is installed.

The system is identified and tracked with these numbers: Order No., System Tag No., System ID No. and Model No.

Language, Time and Date are synchronized with the location of the unit.

The only configurable field is the Password. See [Using the Password](#) on page 113 for more information on configuring and using the password.

### 14.7.1 Logs

Two types of logs are kept by the Vertiv™ Liebert® STS2 / PDU: Event Log and History Log.

#### Event Log

The Event Log tracks the alarms and faults of the Liebert® STS2 / PDU.

See [Alarms and Faults](#) on page 95 for more information on these events and see [Event Log](#) on page 96 for more information on the Event Log and definitions of the fields displayed in the Event Log screen.

Figure 14.15 Event Log

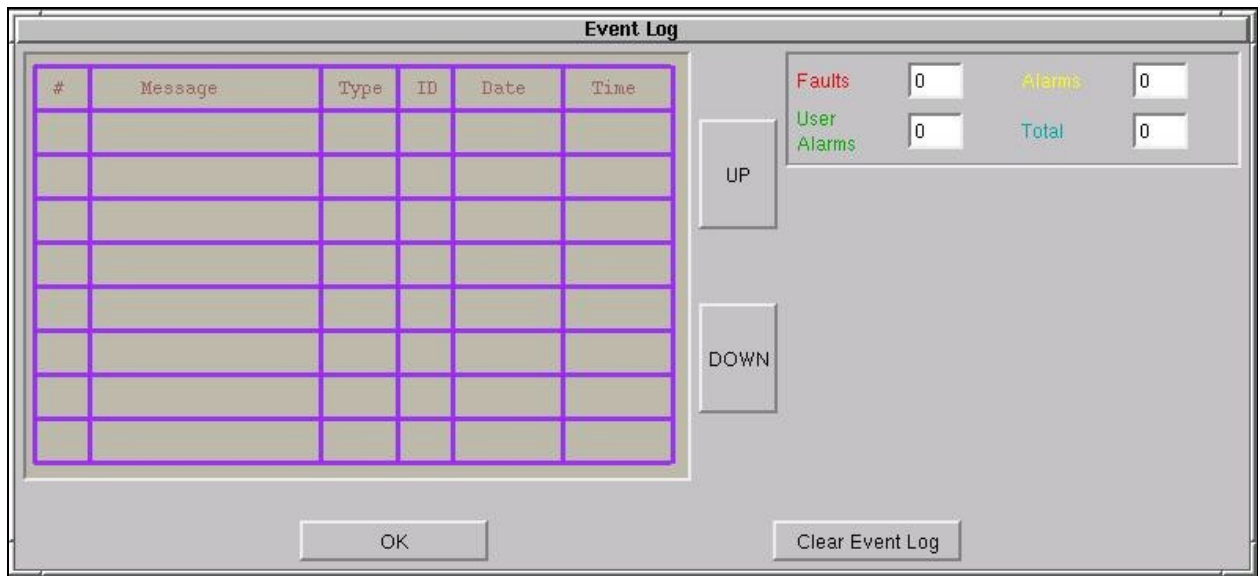

#### To use the Event Log:

1. Select *LOGS* from the menu bar to open the Logs menu.
2. Select *EVENT LOG* from the menu.
3. Use the *UP* and *DOWN* buttons to scroll through the event list.
4. Select *OK* to close the Event Log. The data remains in the log.

#### History Log

Two History Logs are available to track major alarms. If so configured, an alarm freezes the history buffer. When the History Status buffer is frozen, a History Log is created that can be accessed from the HISTORY LOG x choices in the LOGS menu.

See [History Log](#) on page 96 for more information on the History Logs and definitions of the fields displayed in the History Log screen.

Figure 14.16 History Log

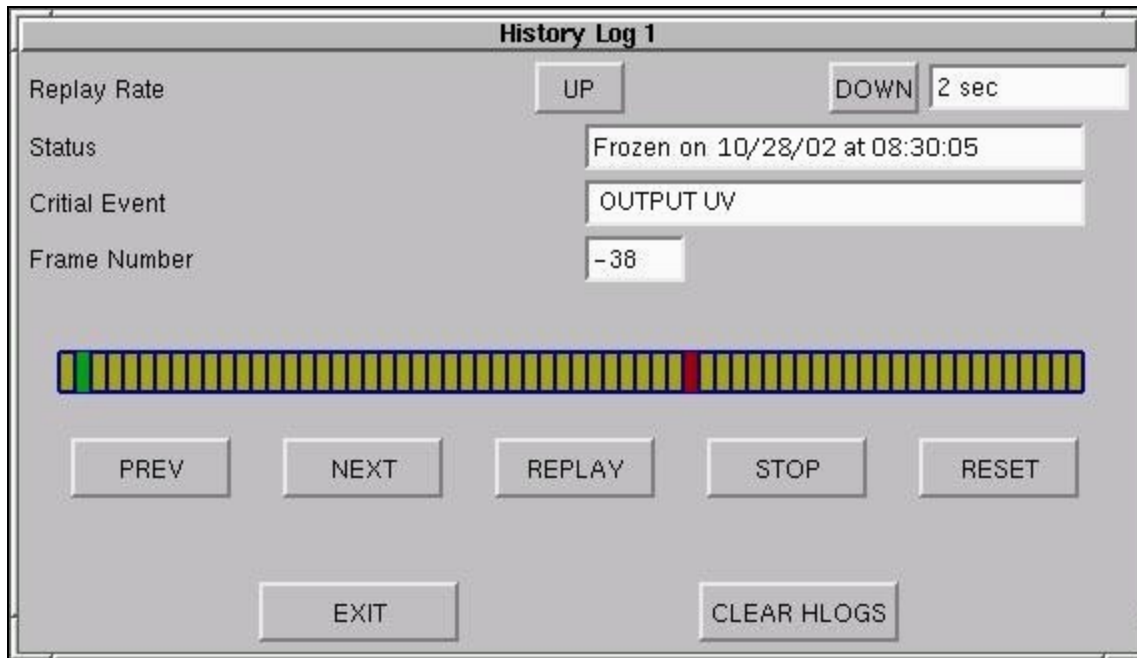

#### To use the History Log:

1. Select *LOGS* from the menu bar to open the Logs menu.
2. Select either *HISTORY LOG 1* or *HISTORY LOG 2* from the menu.
3. Select the *appropriate buttons* to replay the log:
  - Select *PREV* to go to the previous frame in the sequence.
  - Select *NEXT* to go to the next frame in the sequence.
  - Move the green cursor to the location from which you would like to play the sequence of events.
  - Select *REPLAY* to play the frames automatically from the point of the cursor.
  - Select *STOP* to halt the replay.
  - Select *RESET* to return to the first frame in the log.
4. Select *EXIT* to close the History Log. The data remains in the log.
  - Use *CLEAR HLOGS* to remove the data from both history logs.

**NOTE: Event and History Logs are protected by security. The password or a disabled key lockout is required on such equipped units to clear these logs.**

### 14.7.2 Source Transfers

The Source Transfer choice (SOURCE XFERS) allows you to manually select a preferred source. To switch the primary source, refer to [Manual Transfer/ Preferred Source Selection](#) on page 89 .

### 14.7.3 Startup Procedure

You can access instructions for starting the Vertiv™ Liebert® STS2 / PDU from the menu bar.

- From the menu bar, select *STARTUP PROC.*

These instructions are also provided on [Normal System Turn-On](#) on page 87.

### 14.7.4 Bypass Procedure

You can access instructions for bypassing the Liebert® STS2 / PDU from the menu bar.

- From the menu bar, select *BYP. PROC.*

The instructions are provided in the display panel.

Bypass procedures are also discussed in [Maintenance Bypass](#) on page 90.

### 14.7.5 Help

You can select an event in the Event Display to display more information about that event in the Display Panel. This same help is also available in [Event Message Help Text](#) on page 143.

### 14.7.6 Logo

The Logo menu choice shows the Liebert and Vertiv logo in the Display panel.

## 14.8 Cleaning the LCD Touchscreen

If the touchscreen requires cleaning, use a pre-moistened towelette designed for cleaning CRTs or dampen a soft, non-abrasive cloth with a very mild cleaning solution.

Do not spray the cleaner directly onto the touchscreen, as drips may run down into the screen and damage the equipment.

Close all menus and dialog boxes before cleaning the touchscreen.



# 15 Specifications

## 15.1 System Configuration

The Vertiv™ Liebert® STS2 / PDU can be set in several different configurations, according to the model and location. The configuration is set at the factory and does not need to be changed by the customer.

### 15.1.1 Frequency

The Liebert® STS2 / PDU accepts input frequencies of 50 Hz or 60 Hz, depending on the model ordered. The frequency shall be within +/- 0.5 Hz of the nominal frequency.

### 15.1.2 Input Voltage

The Liebert® STS2 / PDU models are available to handle various voltages. The input voltage must be three phase AC (3 wire-plus-ground).

The voltage shall be within +/- 10% of the nominal voltage.

The following table provides nominal voltages, listed according to frequency.

**Table 15.1 Input Voltage**

60 Hz (L-L)	50 Hz (L-L)
208V	208V
380V	380V
400V	400V
415V	415V
480V	-
600V	-

### 15.1.3 Output Voltage

The output voltage shall be three phase AC (4 wire-plus-ground).

**Table 15.2 Output Voltage**

60 Hz (L-L/L-N)	50 Hz (L-L/L-N)
208/120V	208/120V
380/220V	380/220V
400/230V	400/230V
415/240V	415/240V

### 15.1.4 System Current Ratings

These ratings are based upon continuous switch current rating. All units are 100% continuous current rated. Some ratings are not available in certain voltages.

**Table 15.3 System Current Ratings**

Current
250A
400A
600A
800A

### 15.1.5 Grounding

Refer to [System Grounding](#) on page 14 for specifications and instructions regarding grounding.

### 15.1.6 Electrical Requirements

**Table 15.4 Electrical Requirements**

Item	Requirement
Maximum Continuous Current	250, 400, 600, 800 amps
Load Power Factor Range	0.75 to 1.0, leading or lagging
Source Voltage Distortion	Up to 10% THD with notches and ringing transients
Overload Capability	125% for 30 minutes 250A-400A
	125% for 10 minutes 600A-800A
	150% for 2 minutes
	500% for 0.25 sec

**Table 15.5 Unit short Circuit Withstand Capability**

Unit Voltage	Unit Amps	Withstand Capability
208-240V	250A	125kA
	400-600A	100kA
	800A	100kA
380-480V	250A	100kA
	400-600A	100kA
	800A	65kA
600V	250A	50kA
	400-600A	25kA
	800A	25kA

### 15.1.7 Surge Suppression

The static transfer switch is equipped with transient voltage surge suppression on each input for surge suppression. The surge suppression is capable of protecting the static transfer switch from operating outside of tolerances due to surges as defined by IEC 1000-4-5 (1.2/50uS surge, 2kV CM and 1kV DM) as required under EN 50091-2. Optional surge suppression modules (TVSS) are available for each input of the Vertiv™ Liebert® STS2 / PDU for surge protection of the transformers.

### 15.1.8 Response Time

A dual level fast/slow transfer threshold is used for under voltage detection to allow the Liebert® STS2 / PDU to be compatible with UPS's and generators. The voltage thresholds and the slow transfer delay time is user-adjustable. The fast transfer delay time is less than 4 ms.

The over voltage detection uses a single threshold, with programmable level and delay time. See [User Settings](#) on page 117 for instructions on configuring these settings.

### 15.1.9 Environmental Requirements

See [Locating the Vertiv™ Liebert® STS2 / PDU](#) on page 9 for details concerning environmental requirements for the Liebert® STS2 / PDU.

## 15.2 System Components

All Liebert® STS2 / PDU models provide two isolation transformers connected to a solid-state, three-pole, dual-position static transfer switch within one enclosure, with the ability to transfer between two input sources to a single output.

All Liebert® STS2 / PDU are configured with an LCD Color Graphical Interface touchscreen for monitoring and configuring the unit.

### 15.2.1 Frame and Enclosure

The complete Liebert® STS2 / PDU is housed in a freestanding enclosure. The cabinet is a NEMA type 1 enclosure. The cabinet is structurally designed to handle lifting from the base. The frame is designed to accommodate floor stands.

**Table 15.6 Frame Sizes**

Rating	Width x Depth x Height in. (mm)
250A	60 x 32 x 77 (152 x 81 x 196)*
400 – 600A	73 x 49 x 77 (186 x 125 x 196)
800A	96 x 49 x 77 (244 x 125 x 196)
* Width is 76.8 in (195 cm) with output distribution cabinet	

The distributed floor weight for Liebert® STS2 / PDU is less than 260 lb./sq. ft. (118 kg/m<sup>2</sup>).

The required service access is front and one side of the unit, 250A without output cabinet is front access only. Side access depends on which side the output cabinet is mounted, can be left or right.

The Liebert® STS2 / PDU can be tipped 15° in any direction without falling over.

### 15.2.2 Casters - 250A only

The 250A unit frame includes heavy-duty swivel casters for ease of installation, plus stabilizing feet for final installation.

### 15.2.3 Cooling

The Liebert® STS2 / PDU 250A units utilize convection air cooling for the enclosure with forced air cooling of the heat sinks.

The 400-800A units are fan cooled using low-velocity fans to minimize audible noise. All fans are redundant so that a single fan failure cannot cause temperatures to increase beyond acceptable limits.

Air intake is through screened protective openings in the front of the unit. A standard furnace filter is installed behind the openings.

By opening the front door, the filter can be changed easily without exposing personnel to high voltage. The size of the filter is 1 in. x 25 in. x 25 in. (2.54 cm x 63.5 cm x 63.5 cm).

The air exhaust is through the top of the unit.

### 15.2.4 Access

The Liebert® STS2 / PDU is designed so repairs and maintenance can be done from the front, side or top of the unit. All components that may need repair or replacement during routine field maintenance are safely accessed with the units in bypass without removing power from the unit. These components include:

- All electronic PCB assemblies
- Power supply assemblies
- All control fuses
- All circuit breaker plug-in modules
- Fans
- SCRs

All power connections are designed to maintain proper connection torque over the lifetime of the unit without any maintenance. The integrity of the connections can be checked via infrared scanning safely from the front or top of the unit.

All other components including transformers, power cables and connections, circuit breaker bases, etc., are replaceable from the front, rear or top of the unit, but this requires all power to be removed from the unit for safety. Although routine re-torquing of the power connections is not required, if maintenance of these connections is needed, complete removal of power is required from the unit for safety reasons.



**WARNING! Risk of electric shock. Can cause injury or death.**

**Lethal voltages exist inside the unit during normal operation. Only properly trained and qualified service personnel should perform maintenance on the Liebert® STS2 / PDU.**

**The unit is supplied by more than one power source. The unit contains hazardous voltages if any of the input sources is on, even when the unit is in bypass. To isolate the unit, turn off and lock out all input power sources.**

**Verify that all input power sources are de-energized and locked out before making connections inside unit.**

## 15.2.5 Circuit Breakers

The Vertiv™ Liebert® STS2 / PDU is equipped with two input plug-in circuit breakers and five or six (if CB3A is used) molded-case, plug-in, non-automatic circuit breakers. The breakers are UL listed for use up to 600VAC and CE marked. The plug-in feature of the breaker includes an interlock, which prevents the breaker from being unplugged without being in the OFF (Open) position.

Mechanical interlocks are provided on the breakers to prevent improper maintenance bypassing of the solid-state switch. A bypass breaker cannot be closed unless the solid-state switch is connected to the same input source and only one bypass breaker can be closed at a time. All breakers are equipped with N.O. and N.C. auxiliary switches for monitoring of the breaker positions. The two solid-state static switch input breakers are equipped with 48 VDC shunt trips to allow for control by the Liebert® STS2 / PDU logic. See **Table 8.5** on page 77 through **Table 8.7** on page 78.

## 15.2.6 Cable Entrance

Removable conduit termination plates are provided in the top and bottom of the Liebert® STS2 / PDU for termination of the two source input conduits or raceways and/or the output conduits or raceways. On units with inline panelboards, output conduit or raceways are bottom exit only.

## 15.2.7 Doors

A removable key lock hinged front door provides access to the circuit breakers.

## 15.2.8 Color Graphical Display

The display is located in the front of the unit. Front panel display is an LCD touchscreen display for monitoring and configuring the unit. See **Figure 8.50** on page 77 for a drawing of the touchscreen display.

## 15.2.9 RS-232 Port

The unit is equipped with an RS-232 port for connecting a terminal or PC. See **Figure 8.48** on page 76 for the port's location. See [Using the RS-232 Port](#) on page 101 for instructions on using a PC terminal with the unit.

## 15.2.10 Terminal Port Connections

The system has an asynchronous serial port configured as Data Terminal Equipment for terminal access only (half duplex). The CPU services the terminal port with no handshaking. The serial port conforms to RS-232 levels with a data format of 9600 Baud, 1 start bit, 8 data bits and no parity bits. The serial port is 1000VDC isolated (non-SELV) and ESD protected to 15kV air discharge.

The connector is a 6 Pin MTA plug with connections shown in **Table 15.7** below.

**Table 15.7** MTA Plug Pin-Out

Pin	Signal Name	Function / Comments
1	ISO_GND	Isolated service terminal ground
2	ISO_TXD	Isolated service terminal transmit output
3	ISO_RXD	Isolated service terminal receive input
4	NC	No Connection
5	NC	No Connection
6	NC	No Connection

A DB9 male connector is added and connected parallel to the 6 position header. It is configured as DTE.

**Table 15.8 DB9 Pinout**

Pin	Signal Name	Function / Comments
1	NC	No Connection
2	ISO_RXD	Isolated service terminal transmit output
3	ISO_TXD	Isolated service terminal receive input
4	NC	No Connection
5	ISO_GND	Isolated service terminal ground
6	NC	No Connection
7	NC	No Connection
8	NC	No Connection
9	NC	No Connection

### 15.2.11 RS-232 Interface Parameters

The service terminal interface parameters are the following settings and cannot be changed.

**Table 15.9 RS-232 Settings**

Parameter	Setting
Interface	RS-232 Using EIA Voltage Levels
Baud Rate	9600
Parity	None
Number of Data Bits	8
Number of Stop Bits	1
Hardware Flow Control	Off
Terminator	<CR> <LF>
Handshaking	Not supported
Structure	Full duplex
Local Echo	Off

### 15.2.12 Maintenance Bypass

The Vertiv™ Liebert® STS2 / PDU is configured to allow the unit's electronics to be bypassed to either input source for maintenance without interruption of power to the load.

The Liebert® STS2 / PDU is furnished with key-interlocked maintenance bypass breakers to configure the bypass.

Liebert® STS2 / PDU units have all electronics isolated from the input, output and bypass connections to allow safe servicing of any components without access to hazardous voltages when the unit is in maintenance bypass.

See [Maintenance Bypass](#) on page 90 for instructions.

### 15.2.13 Fuseless Design

All Vertiv™ Liebert® STS2 / PDU™ units are fuseless.

### 15.2.14 Options

The following options are available for the Liebert® STS2 / PDU:

- Panelboards
- Subfeed Breakers
- K-Factor Transformers
- Surge Suppression System (TVSS)
- Redundant Static Switch Output Breaker
- Programmable Relay Board
- Comms Board w/Liebert's® SiteScan® and Modem Interface
- Input Contact Isolator Board
- Vertiv™ Liebert® IntelliSlot™ Unity™ Card
- Remote Source Selection
- Key Lockout Switch
- Export Crating

See [Options](#) on page 19 for more information.

This page intentionally left blank



## 16 Event Message Help Text

### Key

- ALL CAPS = Event message displayed in the Event Display panel in the lower left corner of the LCD.
- Indented text = Help text shown in the Display Panel in the lower right corner of LCD.
- BOLD = Commands that are sent through the RS-232 port.

### S1 SCR SHORT

- Source 1 SCR Short
- One or more of the SCRs for Source 1 has shorted. Transferring between sources has been inhibited.
- Contact technical support; in the United States, call 800-543-2378. Outside the 48 contiguous United States contact Vertiv, if available in your area. For international areas not covered by Vertiv, the Vertiv-authorized distributor can provide technical support.
- Press *SILENCE* on the touchscreen to turn off the audible alarm, if so configured. If you are accessing the Vertiv™ Liebert® STS2 / PDU system from a terminal, type SH and press *RETURN* on your keyboard to turn off the audible alarm.
- This event and the system status surrounding it have been written to a History Log if the History Logs were not already full. This event was also written to the Event Log, if so configured.
- The alarm has triggered a message to be sent to the modem, if so configured.

### S2 SCR SHORT

- Source 2 SCR Short.
- One or more of the SCRs for Source 2 has shorted. Transferring between sources has been inhibited.
- Press *SILENCE* on the touchscreen to turn off the audible alarm, if so configured. If you are accessing the Liebert® STS2 / PDU system from a terminal, type SH and press *RETURN* on your keyboard to turn off the audible alarm.
- This event and the system status surrounding it have been written to a History Log if the History Logs were not already full. This event was also written to the Event Log, if so configured.
- The alarm has triggered a message to be sent to the modem, if so configured.

### S1 SCR OPEN

- Source 1 SCR Open.
- One or more SCRs on Source 1 is open. Transferring between sources has been inhibited.
- Contact technical support; in the United States, call 1-800-543-2378. Outside the 48 contiguous United States contact Vertiv, if available in your area. For international areas not covered by Vertiv, the Liebert authorized distributor can provide technical support.
- Liebert® STS2 / PDU output has been transferred to Source 2.
- Press *SILENCE* on the touchscreen to turn off the audible alarm, if so configured. If you are accessing the Liebert® STS2 / PDU system from a terminal, type SH and press *RETURN* on your keyboard to turn off the audible alarm.
- This event and the system status surrounding it have been written to a History Log if the History Logs were not already full. This event was also written to the Event Log, if so configured.
- The alarm has triggered a message to be sent to the modem, if so configured.

## S2 SCR OPEN

- Source 2 SCR Open.
- One or more SCRs on Source 2 is open. Transferring between sources has been inhibited. Vertiv™ Liebert® STS2 / PDU output has been transferred to Source 1.
- Contact technical support; in the United States, call 800-543-2378. Outside the 48 contiguous United States contact Vertiv, if available in your area. For international areas not covered by Vertiv, the Vertiv authorized distributor can provide technical support.
- Press *SILENCE* on the touchscreen to turn off the audible alarm, if so configured. If you are accessing the Liebert® STS2 / PDU system from a terminal, type SH and press *RETURN* on your keyboard to turn off the audible alarm.
- This event and the system status surrounding it have been written to a History Log if the History Logs were not already full. This event was also written to the Event Log, if so configured.
- The alarm has triggered a message to be sent to the modem, if so configured.

## PRIMARY FAN FAIL

- Primary Fan Failure
- One of the primary cooling fans for the Liebert® STS2 / PDU has failed. The alternate fans are now running. The alternate fans are not monitored.
- Contact technical support; in the United States, call 800-543-2378. Outside the 48 contiguous United States contact Vertiv, if available in your area. For international areas not covered by Vertiv, the Vertiv-authorized distributor can provide technical support.
- Press *SILENCE* on the touchscreen to turn off the audible alarm, if so configured. If you are accessing the Liebert® STS2 / PDU system from a terminal, type SH and press *RETURN* on your keyboard to turn off the audible alarm.
- This event was written to the Event Log, if so configured.
- The alarm has triggered a message to be sent to the modem, if so configured.

## CONTROL MODULE FAIL

- Control logic module has failed.
- One of the control modules on the control board has failed.
- Contact technical support; in the United States, call 800-543-2378. Outside the 48 contiguous United States contact Vertiv, if available in your area. For international areas not covered by Vertiv, the Vertiv-authorized distributor can provide technical support.
- Press *SILENCE* on the touchscreen to turn off the audible alarm, if so configured. If you are accessing the Liebert® STS2 / PDU system from a terminal, type SH and press *RETURN* on your keyboard to turn off the audible alarm.
- This event was written to the Event Log, if so configured.
- The alarm has triggered a message to be sent to the modem, if so configured.
- If configured to be a latching alarm, press *RESET* on the display. If you are accessing the unit from a terminal, type CA and press *RETURN* on your keyboard.

**PWR SPLY DC A FAIL**

- Power Supply DC Bus A Failed
- The primary power supply is no longer providing DC power to the control board and the touchscreen.
- Contact technical support; in the United States, call 800-543-2378. Outside the 48 contiguous United States contact Vertiv, if available in your area. For international areas not covered by Vertiv, the Vertiv-authorized distributor can provide technical support.
- Press *SILENCE* on the touchscreen to turn off the audible alarm, if so configured. If you are accessing the Vertiv™ Liebert® STS2 / PDU system from a terminal, type SH and press RETURN on your keyboard to turn off the audible alarm.
- This event was written to the Event Log, if so configured.
- The alarm has triggered a message to be sent to the modem, if so configured.
- If configured to be a latching alarm, press *RESET* on the display. If you are accessing the unit from a terminal, type CA and press RETURN on your keyboard.

**PWR SPLY DC B FAIL**

- Power Supply DC Bus B Failed
- The secondary power supply is no longer providing DC power to the control board and CAN options.
- Contact technical support; in the United States, call 800-543-2378. Outside the 48 contiguous United States contact Vertiv, if available in your area. For international areas not covered by Vertiv, the Vertiv-authorized distributor can provide technical support.
- Press SILENCE on the touchscreen to turn off the audible alarm, if so configured. If you are accessing the Liebert® STS2 / PDU system from a terminal, type SH and press RETURN on your keyboard to turn off the audible alarm.
- This event was written to the Event Log, if so configured.
- The alarm has triggered a message to be sent to the modem, if so configured.
- If configured to be a latching alarm, press *RESET* on the display. If you are accessing the unit from a terminal, type CA and press RETURN on your keyboard.

**PWR SPLY S1 AC FAIL**

- Power Supply Source 1 AC Failed
- The AC input power to the power supplies from Source 1 has failed. The power supplies are now operating on AC power from Source 2. The AC input from Source 1 is still good.
- Contact technical support; in the United States, call 800-543-2378. Outside the 48 contiguous United States contact Vertiv, if available in your area. For international areas not covered by Vertiv, the Vertiv-authorized distributor can provide technical support.
- Press *SILENCE* on the touchscreen to turn off the audible alarm, if so configured. If you are accessing the Liebert® STS2 / PDU system from a terminal, type SH and press RETURN on your keyboard to turn off the audible alarm.
- This event was written to the Event Log, if so configured.
- The alarm has triggered a message to be sent to the modem, if so configured.
- If configured to be a latching alarm, press *RESET* on the display. If you are accessing the unit from a terminal, type CA and press RETURN on your keyboard.

**PWR SPLY S2 AC FAIL**

- Power Supply Source 2 AC Failed
- The AC input power to the power supplies from Source 2 has failed.
- The power supplies are now operating on AC power from Source 1. The AC input from Source 2 is still good.
- Contact technical support; in the United States, call 800-543-2378. Outside the 48 contiguous United States contact Vertiv, if available in your area. For international areas not covered by Vertiv, the Vertiv-authorized distributor can provide technical support.
- Press *SILENCE* on the touchscreen to turn off the audible alarm, if so configured. If you are accessing the Vertiv™ Liebert® STS2 / PDU system from a terminal, type SH and press *RETURN* on your keyboard to turn off the audible alarm.
- This event was written to the Event Log, if so configured.
- The alarm has triggered a message to be sent to the modem, if so configured.
- If configured to be a latching alarm, press *RESET* on the display. If you are accessing the unit from a terminal, type CA and press *RETURN* on your keyboard.

**PWR SPLY LOGIC FAIL**

- Power Supply Module Failed
- The power supply logic module contained in the primary power supply has failed.
- Contact technical support; in the United States, call 800-543-2378. Outside the 48 contiguous United States contact Vertiv, if available in your area. For international areas not covered by Vertiv, the Vertiv-authorized distributor can provide technical support.
- Press *SILENCE* on the touchscreen to turn off the audible alarm, if so configured. If you are accessing the Liebert® STS2 / PDU system from a terminal, type SH and press *RETURN* on your keyboard to turn off the audible alarm.
- This event was written to the Event Log, is so configured.
- The alarm has triggered a message to be sent to the modem, if so configured.
- If configured to be a latching alarm, press *RESET* on the display. If you are accessing the unit from a terminal, type CA and press *RETURN* on your keyboard.

**OUT VOLT SENSE FAIL**

- Output Voltage Sense Module Failed
- The module contained on the snubber monitoring the output voltage has failed.
- Press *SILENCE* on the touchscreen to turn off the audible alarm, if so configured. If you are accessing the Liebert® STS2 / PDU system from a terminal, type SH and press *RETURN* on your keyboard to turn off the audible alarm.
- Contact technical support; in the United States, call 800-543-2378. Outside the 48 contiguous United States contact Vertiv, if available in your area. For international areas not covered by Vertiv, the Vertiv-authorized distributor can provide technical support.
- This event was written to the Event Log, if so configured.
- The alarm has triggered a message to be sent to the modem, if so configured.
- If configured to be a latching alarm, press *RESET* on the display. If you are accessing the unit from a terminal, type CA and press *RETURN* on your keyboard.

### S1 VOLT SENSE FAIL

- Source 1 Voltage Sense Module Failed
- The module contained on the snubber monitoring the input voltage from Source 1 has failed.
- Press *SILENCE* on the touchscreen to turn off the audible alarm, if so configured. If you are accessing the Vertiv™ Liebert® STS2 / PDU system from a terminal, type SH and press *RETURN* on your keyboard to turn off the audible alarm.
- Contact technical support; in the United States, call 800-543-2378. Outside the 48 contiguous United States contact Vertiv, if available in your area. For international areas not covered by Vertiv, the Vertiv-authorized distributor can provide technical support.
- This event was written to the Event Log, if so configured.
- The alarm has triggered a message to be sent to the modem, if so configured.
- If configured to be a latching alarm, press *RESET* on the display. If you are accessing the unit from a terminal, type CA and press *RETURN* on your keyboard.

### S2 VOLT SENSE FAIL

- Source 2 Voltage Sense Module Failed
- The module contained on the snubber monitoring the input voltage from Source 2 has failed.
- Press *SILENCE* on the touchscreen to turn off the audible alarm, if so configured. If you are accessing the Liebert® STS2 / PDU system from a terminal, type SH and press *RETURN* on your keyboard to turn off the audible alarm.
- Contact technical support; in the United States, call 800-543-2378. Outside the 48 contiguous United States contact Vertiv, if available in your area. For international areas not covered by Vertiv, the Vertiv-authorized distributor can provide technical support.
- This event was written to the Event Log, if so configured.
- The alarm has triggered a message to be sent to the modem, if so configured.
- If configured to be a latching alarm, press *RESET* on the display. If you are accessing the Liebert® STS2 / PDU system from a terminal, type CA and press *RETURN* on your keyboard.

### S1 SCR SENSE FAIL

- Source 1 SCR Sense Module Failed
- The module contained on the snubber monitoring the SCRs for Source 1 has failed.
- Press *SILENCE* on the touchscreen to turn off the audible alarm, if so configured. If you are accessing the Liebert® STS2 / PDU system from a terminal, type SH and press *RETURN* on your keyboard to turn off the audible alarm.
- Contact technical support; in the United States, call 800-543-2378. Outside the 48 contiguous United States contact Vertiv, if available in your area. For international areas not covered by Vertiv, the Vertiv-authorized distributor can provide technical support.
- This event was written to the Event Log, if so configured.
- The alarm has triggered a message to be sent to the modem, if so configured.
- If configured to be a latching alarm, press *RESET* on the display. If you are accessing the Liebert® STS2 / PDU system from a terminal, type CA and press *RETURN* on your keyboard.

**S2 SCR SENSE FAIL**

- Source 2 SCR Sense Module Failed
- The module contained on the snubber monitoring the SCRs for Source 2 has failed.
- Press *SILENCE* on the touchscreen to turn off the audible alarm, if so configured. If you are accessing the Vertiv™ Liebert® STS2 / PDU system from a terminal, type SH and press *RETURN* on your keyboard to turn off the audible alarm.
- Contact technical support; in the United States, call 800-543-2378. Outside the 48 contiguous United States contact Vertiv, if available in your area. For international areas not covered by Vertiv, the Vertiv-authorized distributor can provide technical support.
- This event was written to the Event Log, if so configured.
- The alarm has triggered a message to be sent to the modem, if so configured.
- If configured to be a latching alarm, press *RESET* on the display. If you are accessing the Liebert® STS2 / PDU system from a terminal, type CA and press *RETURN* on your keyboard.

**S1 CURR SENSE FAIL**

- Source 1 Current Sense Failure
- The module monitoring the current from Source 1 has failed. This module is contained on the left side gate driver board.
- Press *SILENCE* on the touchscreen to turn off the audible alarm, if so configured. If you are accessing the Liebert® STS2 / PDU system from a terminal, type SH and press *RETURN* on your keyboard to turn off the audible alarm.
- This event was written to the Events Log, is so configured.
- The alarm has triggered a message to be sent to the modem, if so configured.
- If configured to be a latching alarm, press *RESET* on the display. If you are accessing the Liebert® STS2 / PDU system from a terminal, type CA and press *RETURN* on your keyboard.

**S2 CURR SENSE FAIL**

- Source 2 Current Sense Failure
- The module monitoring the current from Source 2 has failed. This module is contained on the right side gate driver board.
- Press *SILENCE* on the touchscreen to turn off the audible alarm, if so configured. If you are accessing the Liebert® STS2 / PDU system from a terminal, type SH and press *RETURN* on your keyboard to turn off the audible alarm.
- This event was written to the Events Log, is so configured.
- The alarm has triggered a message to be sent to the modem, if so configured.
- If configured to be a latching alarm, press *RESET* on the display. If you are accessing the Liebert® STS2 / PDU system from a terminal, type CA and press *RETURN* on your keyboard.

## S1 GATE DRIVE FAIL

- Source 1 Gate Drive Failure
- The gate drive module for an SCR for Source 1 has failed. This module is contained on the right side gate driver board.
- Press *SILENCE* on the touchscreen to turn off the audible alarm, if so configured. If you are accessing the Vertiv™ Liebert® STS2 / PDU system from a terminal, type SH and press *RETURN* on your keyboard to turn off the audible alarm.
- Contact technical support; in the United States, call 800-543-2378. Outside the 48 contiguous United States contact Vertiv, if available in your area. For international areas not covered by Vertiv, the Vertiv-authorized distributor can provide technical support.
- This event was written to the Event Log, if so configured.
- The alarm has triggered a message to be sent to the modem, if so configured.
- If configured to be a latching alarm, press *RESET* on the display. If you are accessing the Liebert® STS2 / PDU system from a terminal, type CA and press *RETURN* on your keyboard.

## S2 GATE DRIVE FAIL

- Source 1 Gate Drive Failure
- The gate drive module for an SCR for Source 2 has failed. This module is contained on the left side gate driver board.
- Press *SILENCE* on the touchscreen to turn off the audible alarm, if so configured. If you are accessing the Liebert® STS2 / PDU system from a terminal, type SH and press *RETURN* on your keyboard to turn off the audible alarm.
- Contact technical support; in the United States, call 800-543-2378. Outside the 48 contiguous United States contact Vertiv, if available in your area. For international areas not covered by Vertiv, the Vertiv-authorized distributor can provide technical support.
- This event was written to the Event Log, if so configured.
- The alarm has triggered a message to be sent to the modem, if so configured.
- If configured to be a latching alarm, press *RESET* on the display. If you are accessing the unit from a terminal, type CA and press *RETURN* on your keyboard.

## INTERNAL COMM FAIL

- Internal CAN Communications Failed
- Communications have failed in the CAN bus between the control board and the touchscreen control.
- Press *SILENCE* on the touchscreen to turn off the audible alarm, if so configured. If you are accessing the Liebert® STS2 / PDU system from a terminal, type SH and press *RETURN* on your keyboard to turn off the audible alarm.
- Contact technical support; in the United States, call 800-543-2378. Outside the 48 contiguous United States contact Vertiv, if available in your area. For international areas not covered by Vertiv, the Vertiv-authorized distributor can provide technical support.
- This event was written to the Event Log, if so configured.
- The alarm has triggered a message to be sent to the modem, if so configured.
- If configured to be a latching alarm, press *RESET* on the display. If you are accessing the unit from a terminal, type CA and press *RETURN* on your keyboard.

**CB1 SHUNT TRIP FAIL**

- Circuit Breaker 1 Shunt Trip Failure
- Circuit Breaker 1 failed to trip open when the control issued a command for the circuit breaker to trip.
- Press *SILENCE* on the touchscreen to turn off the audible alarm, if so configured. If you are accessing the Vertiv™ Liebert® STS2 / PDU system from a terminal, type SH and press *RETURN* on your keyboard to turn off the audible alarm.
- Contact technical support; in the United States, call 800-543-2378. Outside the 48 contiguous United States contact Vertiv, if available in your area. For international areas not covered by Vertiv, the Vertiv-authorized distributor can provide technical support.
- This event was written to the Event Log, if so configured.
- The alarm has triggered a message to be sent to the modem, if so configured.
- If configured to be a latching alarm, press *RESET* on the display. If you are accessing the unit from a terminal, type CA and press *RETURN* on your keyboard.

**CB2 SHUNT TRIP FAIL**

- Circuit Breaker 2 Shunt Trip Failure
- Circuit Breaker 2 failed to trip open when the control issued a command for the circuit breaker to trip.
- Press *SILENCE* on the touchscreen to turn off the audible alarm, if so configured. If you are accessing the Liebert® STS2 / PDU system from a terminal, type SH and press *RETURN* on your keyboard to turn off the audible alarm.
- Contact technical support; in the United States, call 800-543-2378. Outside the 48 contiguous United States contact Vertiv, if available in your area. For international areas not covered by Vertiv, the Vertiv-authorized distributor can provide technical support.
- This event was written to the Event Log, if so configured.
- The alarm has triggered a message to be sent to the modem, if so configured.
- If configured to be a latching alarm, press *RESET* on the display. If you are accessing the unit from a terminal, type CA and press *RETURN* on your keyboard.

**EQUIPMENT FAN FAILURE**

- Equipment Fan Failure
- One of the equipment fans has failed.
- Contact technical support; in the United States, call 800-543-2378. Outside the 48 contiguous United States contact Vertiv, if available in your area. For international areas not covered by Vertiv, the Vertiv-authorized distributor can provide technical support.
- Press *SILENCE* on the touchscreen to turn off the audible alarm, if so configured. If you are accessing the Liebert® STS2 / PDU system from a terminal, type SH and press *RETURN* on your keyboard to turn off the audible alarm.
- This event and the system status surrounding it have been written to a History Log if the History Logs were not already full. This event was also written to the Event Log, if so configured.
- The alarm has triggered a message to be sent to the modem, if so configured.



## INPUT 1 SURGE FAILURE

- Input 1 Surge Failure
- Source 1 input surge suppression module has failed.
- Contact technical support; in the United States, call 800-543-2378. Outside the 48 contiguous United States contact Vertiv, if available in your area. For international areas not covered by Vertiv, the Vertiv-authorized distributor can provide technical support.
- Press *SILENCE* on the touchscreen to turn off the audible alarm, if so configured. If you are accessing the Vertiv™ Liebert® STS2 / PDU system from a terminal, type SH and press *RETURN* on your keyboard to turn off the audible alarm.
- This event and the system status surrounding it have been written to a History Log if the History Logs were not already full. This event was also written to the Event Log, if so configured.
- The alarm has triggered a message to be sent to the modem, if so configured.

## INPUT 2 SURGE FAILURE

- Input 2 Surge Failure
- Source 2 input surge suppression module has failed.
- Contact technical support; in the United States, call 800-543-2378. Outside the 48 contiguous United States contact Vertiv, if available in your area. For international areas not covered by Vertiv, the Vertiv-authorized distributor can provide technical support.
- Press *SILENCE* on the touchscreen to turn off the audible alarm, if so configured. If you are accessing the Liebert® STS2 / PDU system from a terminal, type SH and press *RETURN* on your keyboard to turn off the audible alarm.
- This event and the system status surrounding it have been written to a History Log if the History Logs were not already full. This event was also written to the Event Log, if so configured.
- The alarm has triggered a message to be sent to the modem, if so configured.

## HEAT SINK OVERTEMP

- Heat Sink Over Temperature
- The system heat sink temperature has exceeded the design limits.
- Take immediate steps to cool the unit. Remove obstructions from the air inlet in the front of the unit. Remove and replace the air filter behind the front door. A standard furnace filter can be used.
- Press *SILENCE* on the touchscreen to turn off the audible alarm, if so configured. If you are accessing the Liebert® STS2 / PDU system from a terminal, type SH and press *RETURN* on your keyboard to turn off the audible alarm.
- This event was written to the Event Log, if so configured.
- The alarm has triggered a message to be sent to the modem, if so configured.

## EQUIPMENT OVERTEMP

- Equipment Over Temperature
- Cabinet has exceeded the recommended temperature.
- Contact technical support; in the United States, call 800-543-2378. Outside the 48 contiguous United States contact Vertiv, if available in your area. For international areas not covered by Vertiv, the Vertiv-authorized distributor can provide technical support.
- Press *SILENCE* on the touchscreen to turn off the audible alarm, if so configured. If you are accessing the Liebert® STS2 / PDU system from a terminal, type SH and press *RETURN* on your keyboard to turn off the audible alarm.

- This event and the system status surrounding it have been written to a History Log if the History Logs were not already full. This event was also written to the Event Log, if so configured.

### S1 UV

- Source 1 Under Voltage (fast detection).
- The input voltage from Source 1 dropped below a set percentage of the nominal voltage, as set in the Fast UV setpoint under the User Settings. An S1 Fail alarm was also issued and source transfer has been inhibited.
- The load of the Vertiv™ Liebert® STS2 / PDU has been transferred to Source 2.
- Press *SILENCE* on the touchscreen to turn off the audible alarm, if so configured. If you are accessing the Liebert® STS2 / PDU system from a terminal, type SH and press *RETURN* on your keyboard to turn off the audible alarm.
- This event was written to the Event Log, if so configured.
- The alarm has triggered a message to be sent to the modem, if so configured.
- If configured to be a latching alarm, press *RESET* on the display. If you are accessing the unit from a terminal, type CA and press *RETURN* on your keyboard.

### S1 UV (RMS)

- Source 1 Under Voltage (slow detection).
- The input voltage from Source 1 remained below a set percentage of the nominal voltage for a designated period, as set in the Slow UV Setting and Slow UV Detection Delay setpoints configured under the User Settings. An S1 Fail alarm was also issued and source transfer has been inhibited.
- The load of the Liebert® STS2 / PDU has been transferred to Source 2.
- Press *SILENCE* on the touchscreen to turn off the audible alarm, if so configured. If you are accessing the Liebert® STS2 / PDU system from a terminal, type SH and press *RETURN* on your keyboard to turn off the audible alarm.
- The alarm is latched and must be reset after the voltage returns to the nominal voltage. If the Reset option is not configured for *AUTO* (automatic reset), then the reset action must be done manually. When the voltage is within acceptable parameters, touch the *RESET* button on the touchscreen. If you are accessing the unit from a terminal, type CA and press *RETURN* on your keyboard.
- This event was written to the Event Log, if so configured.
- The alarm has triggered a message to be sent to the modem, if so configured.

### S1 OV

- Source 1 Over Voltage.
- The input voltage from Source 1 exceeded a set percentage of the nominal voltage, as set in the OV Setting and OV Detection Delay setpoints configured under the User Settings. An S1 Fail alarm was also issued and source transfer has been inhibited.
- The load of the Vertiv™ Liebert® STS2 / PDU has been transferred to Source 2.
- Press *SILENCE* on the touchscreen to turn off the audible alarm, if so configured. If you are accessing the Liebert® STS2 / PDU system from a terminal, type SH and press *RETURN* on your keyboard to turn off the audible alarm.
- This event was written to the Event Log, if so configured.
- The alarm has triggered a message to be sent to the modem, if so configured.
- If configured to be a latching alarm, press *RESET* on the display. If you are accessing the unit from a terminal, type CA and press *RETURN* on your keyboard.

**S1 OF/UF**

- Source 1 Over Frequency/Under Frequency
- The frequency for Source 1 is running outside the acceptable operating range, as set in the Frequency Trip Point under User Settings. An S1 Fail alarm was also issued and source transfer has been inhibited.
- Press *SILENCE* on the touchscreen to turn off the audible alarm, if so configured. If you are accessing the Vertiv™ Liebert® STS2 / PDU system from a terminal, type SH and press *RETURN* on your keyboard to turn off the audible alarm.
- This event was written to the Event Log, if so configured.
- The alarm has triggered a message to be sent to the modem, if so configured.
- If configured to be a latching alarm, press *RESET* on the display. If you are accessing the unit from a terminal, type CA and press *RETURN* on your keyboard.

**S1 FAIL**

- Source 1 Failure
- Source 1 has failed due to under voltage (UV), over voltage (OV) or from running over or under frequency (OF/UF). This alarm is a companion to S1 UV, S1 UV (RMS), S1 OV and S1 OF/UF.
- The load of the Liebert® STS2 / PDU has been transferred to Source 2.
- Press *SILENCE* on the touchscreen to turn off the audible alarm, if so configured. If you are accessing the Liebert® STS2 / PDU system from a terminal, type SH and press *RETURN* on your keyboard to turn off the audible alarm.
- This event has been written to the Event Log, if so configured.
- The alarm has triggered a message to be sent to the modem, if so configured.
- If configured to be a latching alarm, press *RESET* on the display. If you are accessing the unit from a terminal, type CA and press *RETURN* on your keyboard.

**S2 UV**

- Source 2 Under Voltage (fast detection).
- The input voltage from Source 2 dropped below a set percentage of the nominal voltage, as set in the Fast UV setpoint under the User Settings. An S2 Fail alarm was also issued and source transfer has been inhibited.
- The load of the Vertiv™ Liebert® STS2 / PDU has been transferred to Source 1.
- Press *SILENCE* on the touchscreen to turn off the audible alarm, if so configured. If you are accessing the Liebert® STS2 / PDU system from a terminal, type SH and press *RETURN* on your keyboard to turn off the audible alarm.
- This event was written to the Event Log, if so configured.
- The alarm has triggered a message to be sent to the modem, if so configured.
- If configured to be a latching alarm, press *RESET* on the display. If you are accessing the unit from a terminal, type CA and press *RETURN* on your keyboard.

**S2 UV (RMS)**

- Source 2 Under Voltage (slow detection).
- The input voltage from Source 2 remained below a set percentage of the nominal voltage for a designated period, as set in the Slow UV Setting and Slow UV Detection Delay setpoints configured under the User Settings. An S2 Fail alarm was also issued and source transfer has been inhibited.
- The load of the Liebert® STS2 / PDU has been transferred to Source 1.

- Press *SILENCE* on the touchscreen to turn off the audible alarm, if so configured. If you are accessing the Vertiv™ Liebert® STS2 / PDU system from a terminal, type SH and press *RETURN* on your keyboard to turn off the audible alarm.
- The alarm is latched and must be reset after the voltage returns to the nominal voltage. If the Reset option is not configured for *AUTO* (automatic reset), then the reset action must be done manually. When the voltage is within acceptable parameters, touch the *RESET* button on the touchscreen. If you are accessing the unit from a terminal, type CA and press *RETURN* on your keyboard.
- This event was written to the Event Log, if so configured.

## S2 OV

- Source 2 Over Voltage.
- The input voltage from Source 2 exceeded a set percentage of the nominal voltage, as set in the OV Setting and OV Detection Delay setpoints configured under the User Settings. An S2 Fail alarm was also issued and source transfer has been inhibited.
- The load of the Liebert® STS2 / PDU has been transferred to Source 1.
- Press *SILENCE* on the touchscreen to turn off the audible alarm, if so configured. If you are accessing the Liebert® STS2 / PDU system from a terminal, type SH and press *RETURN* on your keyboard to turn off the audible alarm.
- This event was written to the Event Log, if so configured.
- The alarm has triggered a message to be sent to the modem, if so configured.
- If configured to be a latching alarm, press *RESET* on the display. If you are accessing the unit from a terminal, type CA and press *RETURN* on your keyboard.

## S2 UF/OF

- Source 2 Under Frequency/Over Frequency
- The frequency for Source 2 is running outside the acceptable operating range, as set in the Frequency Trip Point under User Settings. An S2 Fail alarm was also issued and source transfer has been inhibited.
- Press *SILENCE* on the touchscreen to turn off the audible alarm, if so configured. If you are accessing the Liebert® STS2 / PDU system from a terminal, type SH and press *RETURN* on your keyboard to turn off the audible alarm.
- This event was written to the Event Log, if so configured.
- The alarm has triggered a message to be sent to the modem, if so configured.
- If configured to be a latching alarm, press *RESET* on the display. If you are accessing the unit from a terminal, type CA and press *RETURN* on your keyboard.

## S2 FAIL

- Source 2 Failure
- Source 2 has failed due to under voltage (UV), over voltage (OV) or running with an over or under frequency (OF/UF).
- This alarm is a companion to S2 UV, S2 UV (RMS), S2 OV and S2 OF/UF. The load of the Liebert® STS2 / PDU has been transferred to Source 1.
- Press *SILENCE* on the touchscreen to turn off the audible alarm, if so configured. If you are accessing the Liebert® STS2 / PDU system from a terminal, type SH and press *RETURN* on your keyboard to turn off the audible alarm.
- This event was written to the Event Log, if so configured.
- The alarm has triggered a message to be sent to the modem, if so configured.

- If configured to be a latching alarm, press *RESET* on the display. If you are accessing the unit from a terminal, type *CA* and press *RETURN* on your keyboard.

### S1 OVERCURRENT

- Source 1 Overcurrent
- Vertiv™ Liebert® STS2 / PDU is running on Source 1 and an overload condition has occurred on one or more phases.

**NOTE: The overload setpoint is a single fixed number—101%. An overload condition is detected when the measured load current is equal to or greater than the setpoint.**

- Press *SILENCE* on the touchscreen to turn off the audible alarm, if so configured. If you are accessing the Liebert® STS2 / PDU system from a terminal, type *SH* and press *RETURN* on your keyboard to turn off the audible alarm.
- This event was written to the Event Log, if so configured.
- The alarm has triggered a message to be sent to the modem, if so configured.
- If configured to be a latching alarm, press *RESET* on the display. If you are accessing the unit from a terminal, type *CA* and press *RETURN* on your keyboard.

### S2 OVERCURRENT

- Source 1 Overcurrent
- Liebert® STS2 / PDU is running on Source 2 and an overload condition has occurred on one or more phases.

**NOTE: The overload setpoint is a single fixed number—101%. An overload condition is detected when the measured load current is equal to or greater than the setpoint.**

- Press *SILENCE* on the touchscreen to turn off the audible alarm, if so configured. If you are accessing the Liebert® STS2 / PDU system from a terminal, type *SH* and press *RETURN* on your keyboard to turn off the audible alarm.
- This event was written to the Event Log, if so configured.
- The alarm has triggered a message to be sent to the modem, if so configured.
- If configured to be a latching alarm, press *RESET* on the display. If you are accessing the unit from a terminal, type *CA* and press *RETURN* on your keyboard.

### S1 I-PEAK

- Current Peak on Source 1
- The peak current from Source 1 has exceeded the setpoint as defined in the I-PK Xfer Lockout setting under User Settings.
- Transferring to Source 2 has been inhibited.
- Press *SILENCE* on the touchscreen to turn off the audible alarm, if so configured. If you are accessing the Liebert® STS2 / PDU system from a terminal, type *SH* and press *RETURN* on your keyboard to turn off the audible alarm.
- This event and the system status surrounding it have been written to a History Log if the History Logs were not already full. This event was also written to the Event Log, if so configured.
- If this alarm is configured to automatically reset under the setpoints for User Settings, the alarm clears itself when the I-Peak condition clears.

- If this alarm is set for manual reset mode, the alarm continues to show as active after the current returns to nominal, still inhibiting transfers. You will need to manually reset the alarm. If configured to be a latching alarm, press *RESET* on the display. If you are accessing the unit from a terminal, type *CA* and press *RETURN* on your keyboard.
- The alarm has triggered a message to be sent to the modem, if so configured.

## S2 I-PEAK

- Current Peak on Source 2
- The peak current from Source 2 has exceeded the setpoint as defined in the I-PK Xfer Lockout setting under User Settings.
- Transferring to Source 1 has been inhibited.
- Press *SILENCE* on the touchscreen to turn off the audible alarm, if so configured. If you are accessing the Vertiv™ Liebert® STS2 / PDU system from a terminal, type *SH* and press *RETURN* on your keyboard to turn off the audible alarm.
- This event and the system status surrounding it have been written to a History Log if the History Logs were not already full. This event was also written to the Event Log, if so configured.
- If this alarm is configured to automatically reset under the setpoints for User Settings, the alarm clears itself when the I-Peak condition clears.
- If this alarm is set for manual reset mode, the alarm continues to show as active after the current returns to nominal, still inhibiting transfers. You will need to manually reset the alarm. If configured to be a latching alarm, press *RESET* on the display. If you are accessing the unit from a terminal, type *CA* and press *RETURN* on your keyboard.
- The alarm has triggered a message to be sent to the modem, if so configured.

## SOURCES OUT OF SYNC

- Sources out of synchronization.
- The phase difference between Source 1 and Source 2 has exceeded the deviation as set for *MANUAL MAX XFER PHASE ANGLE* under User Settings.
- A manual transfer cannot take place while the sources are not synchronized.
- Press *SILENCE* on the touchscreen to turn off the audible alarm, if so configured. If you are accessing the Liebert® STS2 / PDU system from a terminal, type *SH* and press *RETURN* on your keyboard to turn off the audible alarm.
- The event was written to the Event Log, if so configured.
- The alarm has triggered a message to be sent to the modem, if so configured.
- If configured to be a latching alarm, press *RESET* on the display. If you are accessing the unit from a terminal, type *CA* and press *RETURN* on your keyboard.

## LOAD ON ALT SOURCE

- Liebert® STS2 / PDU load on the alternate source.
- The Liebert® STS2 / PDU is running on the alternate power source. Check the Event Log to determine the reason for the transfer from the preferred source.
- Another event has caused the system to transfer to the alternate source. The system returns the load to the preferred source either automatically or manually, depending on how the system is configured.
- In automatic reset mode, the Liebert® STS2 / PDU automatically retransfers to the preferred source after the causal condition clears.
- In manual reset mode, the system remains on the alternate source after the causal event clears until you select *RESET* from the touchscreen or enter *CA* (Clear Alarms) from a service terminal.

**NOTE: Pressing the RESET button returns the unit to the preferred source. Ensure that the condition that triggered the switch has been rectified before returning to the preferred source.**

- Press *SILENCE* on the touchscreen to turn off the audible alarm, if so configured. If you are accessing the Vertiv™ Liebert® STS2 / PDU system from a terminal, type SH and press *RETURN* on your keyboard to turn off the audible alarm.
- This event was written to the Event Log, if so configured.
- The alarm has triggered a message to be sent to the modem, if so configured.

#### AUTO REXFER INHIBIT

- Automatic Retransfer Inhibited.
- The system made five transfers from the preferred source to the alternate source in the last five minutes. As a result, automatic retransfers back to the preferred source is now disabled.
- To clear this alarm condition, assign the alternate source as the preferred source.
- This alarm also is cleared if the unit transfers to the preferred source due to an alternate source AC volt failure (i.e., an emergency transfer.)
- Press *SILENCE* on the touchscreen to turn off the audible alarm, if so configured. If you are accessing the Liebert® STS2 / PDU system from a terminal, type SH and press *RETURN* on your keyboard to turn off the audible alarm.
- The event was written to the Event Log, if so configured.
- The alarm has triggered a message to be sent to the modem, if so configured.
- If configured to be a latching alarm, press *RESET* on the display. If you are accessing the unit from a terminal, type CA and press *RETURN* on your keyboard.

#### CB1 (S1) OPEN

- Circuit Breaker 1 (for Source 1) Open
- Circuit Breaker 1 is not closed. CB1 is only assigned to Source 1. Check that the Circuit Breaker 1 switch is in the desired position.
- Press *SILENCE* on the touchscreen to turn off the audible alarm, if so configured. If you are accessing the Liebert® STS2 / PDU system from a terminal, type SH and press *RETURN* on your keyboard to turn off the audible alarm.
- This event was written to the Event Log, if so configured.
- The alarm has triggered a message to be sent to the modem, if so configured.
- If configured to be a latching alarm, press *RESET* on the display. If you are accessing the unit from a terminal, type CA and press *RETURN* on your keyboard.

#### CB2 (S2) OPEN

- Circuit Breaker 2 (for Source 2) Open
- Circuit Breaker 2 is not closed. CB1 is only assigned to Source 2. Check that the Circuit Breaker 2 switch is in the desired position.
- Press *SILENCE* on the touchscreen to turn off the audible alarm, if so configured. If you are accessing the Liebert® STS2 / PDU system from a terminal, type SH and press *RETURN* on your keyboard to turn off the audible alarm.
- This event was written to the Event Log, if so configured.
- The alarm has triggered a message to be sent to the modem, if so configured.
- If configured to be a latching alarm, press *RESET* on the display. If you are accessing the unit from a terminal, type CA and press *RETURN* on your keyboard.

**CB4 (S1 BYP) CLOSED**

- Circuit Breaker 4 (Source 1 Bypass Breaker) Closed
- Circuit breaker 4 is not open. The input from Source 1 is bypassing the Vertiv™ Liebert® STS2 / PDU.
- Press *SILENCE* on the touchscreen to turn off the audible alarm, if so configured. If you are accessing the Liebert® STS2 / PDU system from a terminal, type SH and press *RETURN* on your keyboard to turn off the audible alarm.
- This event was written to the Event Log, if so configured.
- The alarm has triggered a message to be sent to the modem, if so configured.
- If configured to be a latching alarm, press *RESET* on the display. If you are accessing the unit from a terminal, type CA and press *RETURN* on your keyboard.

**CB5 (S1 BYP) CLOSED**

- Circuit Breaker 5 (Source 2 Bypass Breaker) Closed
- Circuit breaker 5 is not open. The input from Source 2 is bypassing the Liebert® STS2 / PDU.
- Press *SILENCE* on the touchscreen to turn off the audible alarm, if so configured. If you are accessing the Liebert® STS2 / PDU system from a terminal, type SH and press *RETURN* on your keyboard to turn off the audible alarm.
- This event was written to the Event Log, if so configured.
- The alarm has triggered a message to be sent to the modem, if so configured.
- If configured to be a latching alarm, press *RESET* on the display. If you are accessing the unit from a terminal, type CA and press *RETURN* on your keyboard.

**CB3 (OUTPUT) OPEN**

- Circuit Breaker 3 (Output breaker) Open
- Circuit breaker 3 is not closed. This circuit breaker is assigned to the output load. The power flow to the load cannot flow through the Liebert® STS2 / PDU.
- Press *SILENCE* on the touchscreen to turn off the audible alarm, if so configured. If you are accessing the Liebert® STS2 / PDU system from a terminal, type SH and press *RETURN* on your keyboard to turn off the audible alarm.
- This event was written to the Event Log, if so configured.
- The alarm has triggered a message to be sent to the modem, if so configured.
- If configured to be a latching alarm, press *RESET* on the display. If you are accessing the unit from a terminal, type CA and press *RETURN* on your keyboard.

**CB3A (OUTPUT) OPEN**

- Circuit Breaker 3A (Output breaker) is Open (Optional)
- Circuit breaker 3A is not closed. This circuit breaker is assigned to the output load. The power flow to the load cannot flow through the Liebert® STS2 / PDU.
- Press *SILENCE* on the touchscreen to turn off the audible alarm, if so configured. If you are accessing the Liebert® STS2 / PDU system from a terminal, type SH and press *RETURN* on your keyboard to turn off the audible alarm.
- This event was written to the Event Log, if so configured.
- The alarm has triggered a message to be sent to the modem, if so configured.
- If configured to be a latching alarm, press *RESET* on the display. If you are accessing the unit from a terminal, type CA and press *RETURN* on your keyboard.



## S1 PHASE ROT ERROR

- Source 1 Phase Rotation Error
- A phase rotation error condition exists on Source 1. Check the phase sequence (ABC) of Source 1. Transferring to Source 1 has been inhibited.
- Press *SILENCE* on the touchscreen to turn off the audible alarm, if so configured. If you are accessing the Vertiv™ Liebert® STS2 / PDU system from a terminal, type SH and press *RETURN* on your keyboard to turn off the audible alarm.
- This event was written to the Event Log, if so configured.
- The alarm has triggered a message to be sent to the modem, if so configured.
- If configured to be a latching alarm, press *RESET* on the display. If you are accessing the unit from a terminal, type CA and press *RETURN* on your keyboard.

## S2 PHASE ROT ERROR

- Source 2 Phase Rotation Error
- A phase rotation error condition exists on Source 2. Check the phase sequence (ABC) of Source 2. Transferring to Source 1 has been inhibited.
- Press *SILENCE* on the touchscreen to turn off the audible alarm, if so configured. If you are accessing the Liebert® STS2 / PDU system from a terminal, type SH and press *RETURN* on your keyboard to turn off the audible alarm.
- This event was written to the Event Log, if so configured.
- The alarm has triggered a message to be sent to the modem, if so configured.
- If configured to be a latching alarm, press *RESET* on the display. If you are accessing the unit from a terminal, type CA and press *RETURN* on your keyboard.

## TRANSFER INHIBITED

- Transfer Inhibited
- Uninterrupted transfer between sources is inhibited due to input source failure, sources out of sync, switch failure or the unit is in bypass mode.
- Check the Event Log for the event or events that may have caused the alarm.
- Press *SILENCE* on the touchscreen to turn off the audible alarm, if so configured. If you are accessing the Liebert® STS2 / PDU system from a terminal, type SH and press *RETURN* on your keyboard to turn off the audible alarm.
- This event was written to the Event Log, if so configured.
- The alarm has triggered a message to be sent to the modem, if so configured.
- If configured to be a latching alarm, press *RESET* on the display. If you are accessing the unit from a terminal, type CA and press *RETURN* on your keyboard.

## OUTPUT UV

- Output Undervoltage
- The voltage being supplied to the load has dropped below the acceptable nominal voltage. Check the input voltage from both sources.
- This event and the system status surrounding it have been written to a History Log if the History Logs were not already full. This event was also written to the Event Log, if so configured.
- Press *SILENCE* on the touchscreen to turn off the audible alarm, if so configured. If you are accessing the Vertiv™ Liebert® STS2 / PDU system from a terminal, type SH and press *RETURN* on your keyboard to turn off the audible alarm.

- The alarm has triggered a message to be sent to the modem, if so configured.
- If configured to be a latching alarm, press *RESET* on the display. If you are accessing the unit from a terminal, type *CA* and press *RETURN* on your keyboard.

#### HISTORY LOG FROZEN

- History Log Frozen
- Both History Logs have been written and no more history logs can be written without clearing one of the logs.
- Contact technical support; in the United States, call 800-543-2378. Outside the 48 contiguous United States contact Vertiv, if available in your area. For international areas not covered by Vertiv, the Vertiv- authorized distributor can provide technical support.
- Press *SILENCE* on the touchscreen to turn off the audible alarm, if so configured. If you are accessing the Vertiv™ Liebert® STS2 / PDU system from a terminal, type *SH* and press *RETURN* on your keyboard to turn off the audible alarm.
- This event and the system status surrounding it have been written to a History Log if the History Logs were not already full. This event was also written to the Event Log, if so configured.

#### INPUT 1 OVERVOLTAGE

- Input 1 Overvoltage Source 1 is over voltage.
- Contact technical support; in the United States, call 800-543-2378. Outside the 48 contiguous United States contact Vertiv, if available in your area. For international areas not covered by Vertiv, the Vertiv- authorized distributor can provide technical support.
- Press *SILENCE* on the touchscreen to turn off the audible alarm, if so configured. If you are accessing the Liebert® STS2 / PDU system from a terminal, type *SH* and press *RETURN* on your keyboard to turn off the audible alarm.
- This event and the system status surrounding it have been written to a History Log if the History Logs were not already full. This event was also written to the Event Log, if so configured.

#### INPUT 1 UNDERVOLTAGE

- Input 1 Undervoltage Source 1 is under voltage.
- Contact technical support; in the United States, call 800-543-2378. Outside the 48 contiguous United States contact Vertiv, if available in your area. For international areas not covered by Vertiv, the Vertiv- authorized distributor can provide technical support.
- Press *SILENCE* on the touchscreen to turn off the audible alarm, if so configured. If you are accessing the Liebert® STS2 / PDU system from a terminal, type *SH* and press *RETURN* on your keyboard to turn off the audible alarm.
- This event and the system status surrounding it have been written to a History Log if the History Logs were not already full. This event was also written to the Event Log, if so configured.

## INPUT 2 OVERVOLTAGE

- Input 2 Overvoltage Source 2 is over voltage.
- Contact technical support; in the United States, call 800-543-2378. Outside the 48 contiguous United States contact Vertiv, if available in your area. For international areas not covered by Vertiv, the Vertiv- authorized distributor can provide technical support.
- Press *SILENCE* on the touchscreen to turn off the audible alarm, if so configured. If you are accessing the Vertiv™ Liebert® STS2 / PDU system from a terminal, type SH and press *RETURN* on your keyboard to turn off the audible alarm.
- This event and the system status surrounding it have been written to a History Log if the History Logs were not already full. This event was also written to the Event Log, if so configured.

## INPUT 2 UNDERVOLTAGE

- Input 2 Undervoltage Source 2 is under voltage.
- Contact technical support; in the United States, call 800-543-2378. Outside the 48 contiguous United States contact Vertiv, if available in your area. For international areas not covered by Vertiv, the Vertiv- authorized distributor can provide technical support.
- Press *SILENCE* on the touchscreen to turn off the audible alarm, if so configured. If you are accessing the Liebert® STS2 / PDU system from a terminal, type SH and press *RETURN* on your keyboard to turn off the audible alarm.
- This event and the system status surrounding it have been written to a History Log if the History Logs were not already full. This event was also written to the Event Log, if so configured.

## LOAD OVERCURRENT

- Load Overcurrent Output is over current.
- Contact technical support; in the United States, call 800-543-2378. Outside the 48 contiguous United States contact Vertiv, if available in your area. For international areas not covered by Vertiv, the Vertiv- authorized distributor can provide technical support.
- Press *SILENCE* on the touchscreen to turn off the audible alarm, if so configured. If you are accessing the Liebert® STS2 / PDU system from a terminal, type SH and press *RETURN* on your keyboard to turn off the audible alarm.
- This event and the system status surrounding it have been written to a History Log if the History Logs were not already full. This event was also written to the Event Log, if so configured.

## GROUND OVERCURRENT

- Ground Overcurrent Ground is over current.
- Contact technical support; in the United States, call 800-543-2378. Outside the 48 contiguous United States contact Vertiv, if available in your area. For international areas not covered by Vertiv, the Vertiv- authorized distributor can provide technical support.
- Press *SILENCE* on the touchscreen to turn off the audible alarm, if so configured. If you are accessing the Liebert® STS2 / PDU system from a terminal, type SH and press *RETURN* on your keyboard to turn off the audible alarm.
- This event and the system status surrounding it have been written to a History Log if the History Logs were not already full. This event was also written to the Event Log, if so configured.

## NEUTRAL OVERCURRENT

- Neutral Overcurrent Neutral is over current.
- Contact technical support; in the United States, call 800-543-2378. Outside the 48 contiguous United States contact Vertiv, if available in your area. For international areas not covered by Vertiv, the Vertiv- authorized distributor can provide technical support.
- Press *SILENCE* on the touchscreen to turn off the audible alarm, if so configured. If you are accessing the Vertiv™ Liebert® STS2 / PDU system from a terminal, type SH and press *RETURN* on your keyboard to turn off the audible alarm.
- This event was also written to the Event Log, if so configured.

## LOAD VOLTAGE THD

- Load Voltage Total Harmonic Distortion Voltage THD has exceeded the set limit.
- Contact technical support; in the United States, call 800-543-2378. Outside the 48 contiguous United States contact Vertiv, if available in your area. For international areas not covered by Vertiv, the Vertiv- authorized distributor can provide technical support.
- Press *SILENCE* on the touchscreen to turn off the audible alarm, if so configured. If you are accessing the Liebert® STS2 / PDU system from a terminal, type SH and press *RETURN* on your keyboard to turn off the audible alarm.
- This event was also written to the Event Log, if so configured.

## INPUT 1 CB6 OPEN

- Input 1 CB6 Open
- Source 1 input Circuit Breaker 6 is open.
- Contact technical support; in the United States, call 800-543-2378. Outside the 48 contiguous United States contact Vertiv, if available in your area. For international areas not covered by Vertiv, the Vertiv- authorized distributor can provide technical support.
- Press *SILENCE* on the touchscreen to turn off the audible alarm, if so configured. If you are accessing the Liebert® STS2 / PDU system from a terminal, type SH and press *RETURN* on your keyboard to turn off the audible alarm.
- This event was also written to the Event Log, if so configured.

## INPUT 2 CB7 OPEN

- Input 2 CB7 Open
- Source 2 Input Circuit Breaker 7 is open.
- Contact technical support; in the United States, call 800-543-2378. Outside the 48 contiguous United States contact Vertiv, if available in your area. For international areas not covered by Vertiv, the Vertiv- authorized distributor can provide technical support.
- Press *SILENCE* on the touchscreen to turn off the audible alarm, if so configured. If you are accessing the Liebert® STS2 / PDU system from a terminal, type SH and press *RETURN* on your keyboard to turn off the audible alarm.
- This event was also written to the Event Log, if so configured.

**INPUT 1 OF/UF**

- Input 1 Over Frequency/Under Frequency Source 1 is over frequency/under frequency
- Contact technical support; in the United States, call 800-543-2378. Outside the 48 contiguous United States contact Vertiv, if available in your area. For international areas not covered by Vertiv, the Vertiv- authorized distributor can provide technical support.
- Press *SILENCE* on the touchscreen to turn off the audible alarm, if so configured. If you are accessing the Vertiv™ Liebert® STS2 / PDU system from a terminal, type SH and press *RETURN* on your keyboard to turn off the audible alarm.
- This event was also written to the Event Log, if so configured.

**INPUT 2 OF/UF**

- Input 2 Over Frequency/Under Frequency Source 2 is over frequency/under frequency.
- Contact technical support; in the United States, call 800-543-2378. Outside the 48 contiguous United States contact Vertiv, if available in your area. For international areas not covered by Vertiv, the Vertiv- authorized distributor can provide technical support.
- Press *SILENCE* on the touchscreen to turn off the audible alarm, if so configured. If you are accessing the Liebert® STS2 / PDU system from a terminal, type SH and press *RETURN* on your keyboard to turn off the audible alarm.
- This event was also written to the Event Log, if so configured.

**INPUT CONTACT #1**

- Input Contact Isolator #1
- Occurrence of the indicated external event has been detected by Input Contact Isolator #1 of the Open Comms Digital Input option board.
- Press *SILENCE* on the touchscreen to turn off the audible alarm, if so configured. If you are accessing the Liebert® STS2 / PDU system from a terminal, type SH and press *RETURN* on your keyboard to turn off the audible alarm.
- The event, with its assigned name, was written to the Event Log, if so configured. The alarm has triggered a message to be sent to the modem, if so configured.
- If configured to be a latching alarm, press *RESET* on the display. If you are accessing the unit from a terminal, type CA and press *RETURN* on your keyboard.

**INPUT CONTACT #2**

- Input Contact Isolator #2
- Occurrence of the indicated external event has been detected by Input Contact Isolator #2 of the Open Comms Digital Input option board.
- Press *SILENCE* on the touchscreen to turn off the audible alarm, if so configured. If you are accessing the Liebert® STS2 / PDU system from a terminal, type SH and press *RETURN* on your keyboard to turn off the audible alarm.
- The event, with its assigned name, was written to the Event Log, if so configured. The alarm has triggered a message to be sent to the modem, if so configured.
- If configured to be a latching alarm, press *RESET* on the display. If you are accessing the unit from a terminal, type CA and press *RETURN* on your keyboard.

**INPUT CONTACT #3**

- Input Contact Isolator #3
- Occurrence of the indicated external event has been detected by Input Contact Isolator #3 of the Open Comms Digital Input option board.
- Press *SILENCE* on the touchscreen to turn off the audible alarm, if so configured. If you are accessing the Vertiv™ Liebert® STS2 / PDU system from a terminal, type SH and press *RETURN* on your keyboard to turn off the audible alarm.
- The event, with its assigned name, was written to the Event Log, if so configured. The alarm has triggered a message to be sent to the modem, if so configured.
- If configured to be a latching alarm, press *RESET* on the display. If you are accessing the unit from a terminal, type CA and press *RETURN* on your keyboard.

**INPUT CONTACT #4**

- Input Contact Isolator #4
- Occurrence of the indicated external event has been detected by Input Contact Isolator #4 of the Open Comms Digital Input option board.
- Press *SILENCE* on the touchscreen to turn off the audible alarm, if so configured. If you are accessing the Vertiv™ Liebert® STS2 / PDU system from a terminal, type SH and press *RETURN* on your keyboard to turn off the audible alarm.
- The event, with its assigned name, was written to the Event Log, if so configured. The alarm has triggered a message to be sent to the modem, if so configured.
- If configured to be a latching alarm, press *RESET* on the display. If you are accessing the unit from a terminal, type CA and press *RETURN* on your keyboard.

**INPUT CONTACT #5**

- Input Contact Isolator #5
- Occurrence of the indicated external event has been detected by Input Contact Isolator #5 of the Open Comms Digital Input option board.
- Press *SILENCE* on the touchscreen to turn off the audible alarm, if so configured. If you are accessing the Liebert® STS2 / PDU system from a terminal, type SH and press *RETURN* on your keyboard to turn off the audible alarm.
- The event, with its assigned name, was written to the Event Log, if so configured. The alarm has triggered a message to be sent to the modem, if so configured.
- If configured to be a latching alarm, press *RESET* on the display. If you are accessing the unit from a terminal, type CA and press *RETURN* on your keyboard.

**INPUT CONTACT #6**

- Input Contact Isolator #6
- Occurrence of the indicated external event has been detected by Input Contact Isolator #6 of the Open Comms Digital Input option board.
- Press *SILENCE* on the touchscreen to turn off the audible alarm, if so configured. If you are accessing the Liebert® STS2 / PDU system from a terminal, type SH and press *RETURN* on your keyboard to turn off the audible alarm.
- The event, with its assigned name, was written to the Event Log, if so configured. The alarm has triggered a message to be sent to the modem, if so configured.
- If configured to be a latching alarm, press *RESET* on the display. If you are accessing the unit from a terminal, type CA and press *RETURN* on your keyboard.

**INPUT CONTACT #7**

- Input Contact Isolator #7
- Occurrence of the indicated external event has been detected by Input Contact Isolator #7 of the Open Comms Digital Input option board.
- Press *SILENCE* on the touchscreen to turn off the audible alarm, if so configured. If you are accessing the Vertiv™ Liebert® STS2 / PDU system from a terminal, type SH and press RETURN on your keyboard to turn off the audible alarm.
- The event, with its assigned name, was written to the Event Log, if so configured. The alarm has triggered a message to be sent to the modem, if so configured.
- If configured to be a latching alarm, press *RESET* on the display. If you are accessing the unit from a terminal, type CA and press RETURN on your keyboard.

**INPUT CONTACT #8**

- Input Contact Isolator #8
- Occurrence of the indicated external event has been detected by Input Contact Isolator #8 of the Open Comms Digital Input option board.
- Press *SILENCE* on the touchscreen to turn off the audible alarm, if so configured. If you are accessing the Liebert® STS2 / PDU system from a terminal, type SH and press RETURN on your keyboard to turn off the audible alarm.
- The event, with its assigned name, was written to the Event Log, if so configured. The alarm has triggered a message to be sent to the modem, if so configured.
- If configured to be a latching alarm, press *RESET* on the display. If you are accessing the unit from a terminal, type CA and press RETURN on your keyboard.

**CONFIG MODIFIED**

- Configuration Modified
- A setpoint has been updated and saved.
- The event was written to the Event Log, if so configured.

**PASSWORD CHANGED**

- Access Password Changed
- The password for accessing the HMI (touchscreen) options has been updated and saved. The event was written to the Event Log, if so configured.

**TIME REPROGRAMMED**

- System Time Reprogrammed
- The system's time setting has been updated and saved. The event was written to the Event Log, if so configured.

**DATE REPROGRAMMED**

- System Date Reprogrammed
- The system's date setting has been updated and saved. The event was written to the Event Log, if so configured.

**EVENT LOG CLEARED**

- Event Log Cleared
- All past alarms and faults are no longer recorded in the system's event log. This event was written to the Event Log, if so configured.

#### **HIST LOGS CLEARED**

- History Logs Cleared
- Both History Logs have been erased and the logs are now available to record future events. The event was written to the Event Log, if so configured.

#### **TRANSFER COUNTER CLEARED**

- Transfer Counter Cleared Transfer counter reset to 0
- Contact technical support; in the United States, call 800-543-2378. Outside the 48 contiguous United States contact Vertiv, if available in your area. For international areas not covered by Vertiv, the Vertiv- authorized distributor can provide technical support.
- This event was also written to the Event Log, if so configured.

#### **KW-HRS COUNTER CLEARED**

- KW-HRS counter cleared KW-Hrs counter reset to 0
- Contact technical support; in the United States, call 800-543-2378. Outside the 48 contiguous United States contact Vertiv, if available in your area. For international areas not covered by Vertiv, the Vertiv- authorized distributor can provide technical support.
- This event was also written to the Event Log, if so configured.



## 17 Maintenance



**WARNING! Risk of electric shock. Can cause injury or death.**

**Only properly trained and qualified service personnel should perform maintenance on the Vertiv™ Liebert® STS2 / PDU.**

**Lethal voltages exist inside the unit during normal operation.**

**The unit is supplied by multiple AC power sources. Disconnect and lock out all power sources before working inside unit.**

Minimal periodic maintenance of the Liebert® STS2 / PDU is required. As with all electrical distribution components, the system should be regularly inspected for electrical connection integrity, signs of excessive temperatures, dirt accumulation and proper system operation.

### 17.1 Proper Tightening of Nuts and Bolts

The recommended tightening torque for all nuts and bolts is as shown below, unless otherwise labeled. All power connections are designed to remain at proper torque throughout the lifetime of the unit.

**Table 17.1 Proper Tightening of Nuts and Bolts**

Bolt Shaft Size	Grade 5 - Imperial Grade 8.8 - Metric		Electrical Connections with Belleville Washers	
	in-lb (pound-inch)	N-m (Newton-meter)	in-lb (pound-inch)	N-m (Newton-meter)
10-32	25	3	35	4
1/4-20	53	6	80	9.0
5/16-18	107	12	180	20.4
3/8-16	192	22	240	27.1
1/2-13	428	48	480	54.3

**Table 17.2 Branch circuit breakers**

Current Rating	in-lb (pound-inch)	N-m (Newton-meter)
Up to 30 Amp	35	4.0
40 to 100 Amp	45	5.1

### 17.2 Testing the Liebert® STS2/PDU™

The Liebert® STS2/PDU™ includes comprehensive system alarms and fault detection to identify operational problems. To increase the degree of confidence of proper system operation, periodic transfer tests can be easily performed. For instructions for changing the preferred source and switching sources, see [Manual Transfer/ Preferred Source Selection](#) on page 89.

### 17.3 Changing the Air Filter

A standard furnace filter is installed behind the air intake in the front door. The air intake allows air to circulate to cool the unit. Replace the filter when it becomes dirty and impedes air flow. The frequency of changing or cleaning the filter depends on the location in which the unit is located. The size of the filter is 1 x 25 x 25 in. (254 x 635 x 635mm).

This page intentionally left blank

# 18 Customer Settings

## 18.1 Programmable Relay Board Settings

The optional programmable relay board (PRB) has eight channels to report events to an external device. Up to ten (10) events can be programmed to each channel. See [Programmable Relay Board](#) on page 19 for more information on the PRB.

If your Vertiv™ Liebert® STS2 / PDU has the PRB option installed, list the settings below for future reference. If control power is lost in the Liebert® STS2 / PDU, the settings are not saved.

**Table 18.1 Programmable Relay Board Settings Record**

Channel 1		
Channel 2		
Channel 3		
Channel 4		
Channel 5		
Channel 6		
Channel 7		
Channel 8		

**Table 18.1 Programmable Relay Board Settings Record (continued)**

Channel 9		
Channel 10		
PRB Notes		

## 18.2 Input Contact Isolator Settings

The Input Contact Isolator board (ICI) provides a Vertiv™ Liebert® STS2 / PDU module interface for up to eight external user alarm or message inputs to be routed through the Liebert® STS2 / PDU alarm network. See [Input Contact Isolator Board](#) on page 20 for more information on the ICI.

If your Liebert® STS2 / PDU has the ICI option installed, list the settings below for future reference.

If control power is lost in the Liebert® STS2 / PDU, the settings are not saved.

**Table 18.2 Input Contact Isolator Settings Record**

Channel 1	
Channel 2	
Channel 3	
Channel 4	
Channel 5	
Channel 6	
Channel 7	
Channel 8	

### **Connect with Vertiv on Social Media**



<https://www.facebook.com/vertiv/>



<https://www.instagram.com/vertiv/>



<https://www.linkedin.com/company/vertiv/>



<https://www.twitter.com/Vertiv/>



---

Vertiv.com | Vertiv Headquarters, 1050 Dearborn Drive, Columbus, OH, 43085, USA

© 2021 Vertiv Group Corp. All rights reserved. Vertiv™ and the Vertiv logo are trademarks or registered trademarks of Vertiv Group Corp. All other names and logos referred to are trade names, trademarks or registered trademarks of their respective owners. While every precaution has been taken to ensure accuracy and completeness here, Vertiv Group Corp. assumes no responsibility, and disclaims all liability, for damages resulting from use of this information or for any errors or omissions. Specifications, rebates and other promotional offers are subject to change at Vertiv's sole discretion upon notice.

SL-20730\_REV9\_12-21