

SYSTEM OVERVIEW

Description: See Table 1 for descriptions of the configured systems. Refer also to the following.

| Spec. No. | Description | 40 °C Rating | | | 65 °C Rating | | |
|--------------|---|-----------------|-----------------|---------------|-----------------|-----------------|-----------------|
| | | 100 VAC | 120 VAC | 208 / 240 VAC | 100 VAC | 120 VAC | 208 / 240 VAC |
| 582137100101 | -48 VDC 350 A Power System e/w (2) LVLD's and LVBD (no front door and top cover). | N/A | | | 217 A / 10.4 kW | 278 A / 13.3 kW | 350 A / 16.8 kW |
| 582137100102 | -48 VDC 500 A Power System e/w (2) LVLD's and LVBD. | 281 A / 13.5 kW | 360 A / 17.2 kW | 500 A / 24 kW | N/A | | |
| 582137100103 | -48 VDC 350 A Power System e/w no LVD's (no front door and top cover). | N/A | | | 217 A / 10.4 kW | 278 A / 13.3 kW | 350 A / 16.8 kW |
| 582137100104 | -48 VDC 500 A Power System e/w no LVD's. | 281 A / 13.5 kW | 360 A / 17.2 kW | 500 A / 24 kW | N/A | | |
| 582137100105 | -48 VDC 350 A Power System e/w LVBD (no front door and top cover). | N/A | | | 217 A / 10.4 kW | 278 A / 13.3 kW | 350 A / 16.8 kW |
| 582137100106 | -48 VDC 500 A Power System e/w LVBD. | 281 A / 13.5 kW | 360 A / 17.2 kW | 500 A / 24 kW | N/A | | |

Table 1
Configured Systems Descriptions

The Vertiv™ NetSure™ 7100 Compact DC Power System is an integrated power system containing -48 VDC output rectifiers, intelligent control, metering, monitoring, and distribution.

This system is designed to power a load while charging a positive grounded battery. This system is capable of operating in a batteryless installation or off battery for maintenance purposes. The system is designed for operation with the positive output grounded.

This system consists of the following components.

- **NCU (NetSure Control Unit) Controller**

The NCU controller provides power system control (including optional low voltage battery disconnect (LVBD) and optional low voltage load disconnect (LVLD) control), rectifier module control (including a charge control function), metering functions, monitoring functions, local/remote alarm functions, and connections for binary inputs and programmable relay outputs via controller interface boards. The controller also supports rectifier temperature compensation if the system is equipped with a temperature probe(s). Temperature probe(s) may also be designated to monitor ambient temperature and/or battery temperature. The controller also provides data acquisition, system alarm management, and advanced battery and energy management. The controller contains a color TFT display and keypad for local access. The controller provides an Ethernet port and comes with comprehensive webpages for remote access. The controller has SNMP V3 capability for remote system management. The controller supports software upgrade via its USB port. Refer to the NCU Controller Instructions (UM1M830BNA) for more information.

- **Rectifiers**

The system contains nine (9) rectifier mounting positions for the Spec. No. 1R483500e3 rectifier. The rectifiers provide load power, battery float current, and battery recharge current during normal operating conditions. Refer to the Rectifier Instructions (UM1R483500E3) for more information.

- **Distribution**

The system contains a 1-row distribution panel. The distribution panel accepts bullet nose type circuit breakers.

- **Low Voltage Load Disconnect (LVLD) and Low Voltage Battery Disconnect (LVBD)**

Spec. No 582137100101 and 582137100102 provides two (2) LVLD and one (1) LVBD.

Spec. No 582137100103 and 582137100104 provides no LVDs.

Spec. No 582137100105 and 582137100106 provides one (1) LVBD.

Vertiv™ NetSure™ 7100 Compact DC Power System

System Application Guide

582137100101, 582137100103, 582137100105

582137100102, 582137100104, 582137100106

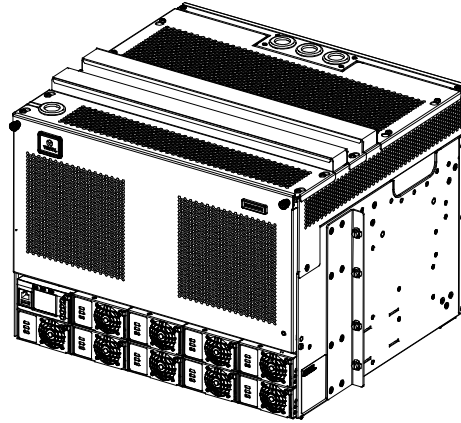
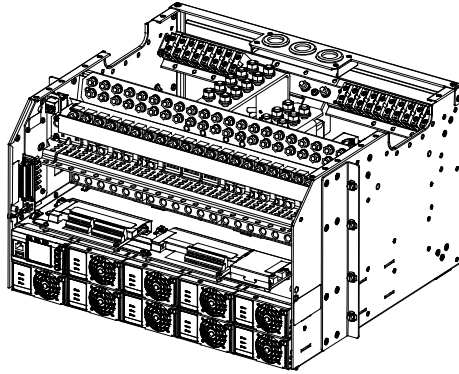

| No Covers | Covers | Low Voltage Disconnect |
|--------------|--------------|------------------------|
| 582137100101 | 582137100102 | (2) LVLVD, (1) LVBD |
| 582137100103 | 582137100104 | No LVD |
| 582137100105 | 582137100106 | (1) LVBD |

General Specifications

See detailed specifications starting on page 38.

| | |
|--------------------------------|---|
| Family: | NetSure™ |
| Spec. Nos.: | 582137100101, 582137100102, 582137100103, 582137100104, 582137100105, 582137100106 |
| Model: | NetSure™ 7100 Compact |
| System AC Input Voltage: | Nominal 208 VAC / 240 VAC, single phase, 50 Hz / 60 Hz, with an operating range of 176 VAC to 275 VAC. Acceptable input frequency range is 45 Hz to 65 Hz. Nominal 100 VAC / 120 VAC, single phase, 50 Hz / 60 Hz, with an operating range of 85 VAC to 132 VAC. Acceptable input frequency range is 45 Hz to 65 Hz. |
| System AC Input Current: | 17.9 A @ 208 VAC, 15.5 A @ 240 VAC (per individual rectifier AC input branch circuit). 18.8 A @ 100 VAC, 19.8 A @ 120 VAC (per individual rectifier AC input branch circuit). |
| DC Output Capacity: | |
| System: | See “Description” on page 1. |
| Distribution Panel: | 500 A, maximum |
| 1R483500e3 Rectifier Rating: | See UM1R483500E3. |
| System Agency Approval: | UL 62368-1 Recognized (“cURus”), NEBS, GR-3108 |
| Framework Type: | Rack Mounted in a Relay Rack or Cabinet (Wall Mounting Option Available) |
| Mounting Width: | See “Mechanical Specifications” starting on page 40. |
| Mounting Depth: | See “Mechanical Specifications” starting on page 40. |
| Access: | Front for Operation and Maintenance Front and Rear for Installation |
| Supplemental Bay(s) Available: | None |
| Control: | Microprocessor |
| Color: | Bay and Module Faceplates: Textured Gray Module Mounting Assembly and Module Bodies: Galvanized Steel |
| Environment: | See “Operating Ambient Temperature Range:” on page 38. |

Vertiv™ NetSure™ 7100 Compact DC Power System

System Application Guide

TABLE OF CONTENTS

| | |
|---|----|
| SYSTEM OVERVIEW | 1 |
| MAIN COMPONENTS ILLUSTRATIONS..... | 5 |
| 582137100101, 52137100103, 582137100105 Configured System..... | 5 |
| 582137100102, 52137100104, 582137100106 Configured System..... | 6 |
| 582137100101, 52137100102, 582137100103, 582137100104, 52137100105, 582137100106 Configured System..... | 7 |
| LIST DESCRIPTIONS | 8 |
| Configured Systems..... | 8 |
| 582137100101: Configured System | 8 |
| 582137100102: Configured System..... | 9 |
| 582137100103: Configured System | 10 |
| 582137100104: Configured System | 11 |
| 582137100105: Configured System | 12 |
| 582137100106: Configured System | 13 |
| ACCESSORY DESCRIPTIONS | 14 |
| Relay Racks | 14 |
| 19" to 23" Wide Relay Rack Mounting Bracket Kit, P/N 553630..... | 14 |
| Optional Wall Mounting Bracket Kit, P/N 565533 | 15 |
| NCU (NetSure Control Unit) Controller, P/N 1M830BNA..... | 15 |
| Optional Temperature Probes..... | 15 |
| Optional SM-Temp Temperature Concentrator | 16 |
| SM-Temp Temperature Concentrator, P/N 547490 | 16 |
| SM-Temp CAN Bus Interface Cable, P/N 562868..... | 17 |
| SM-Temp Jumpers, P/N 552888..... | 17 |
| Rectifier Module, P/N 1R483500e3..... | 17 |
| Module Mounting Position Blank Cover Panel, P/N SXA 110 0035/1..... | 17 |
| Distribution Devices..... | 18 |
| Bullet Nose Type Circuit Breakers..... | 18 |
| Bullet Nose Bypass Busbar, P/N 535015..... | 18 |
| Standard Crimp Lugs, Special Application Crimp Lugs, and Busbar Adapter Kits and Hardware Kits..... | 20 |
| Standard Crimp Lugs | 20 |
| Special Application Crimp Lug / Strap Combination, Busbar Lug Adapters, and Hardware Kits..... | 21 |
| User Replaceable Components..... | 22 |
| RECOMMENDED WIRE SIZES, BRANCH CIRCUIT PROTECTION, CRIMP LUGS, AND WIRING ILLUSTRATIONS..... | 23 |
| Relay Rack / Equipment Cabinet Frame Grounding Requirements | 23 |
| System Shelf and Wall Mount Bracket Frame Grounding Connection | 23 |
| Central Office Grounding Connection..... | 25 |
| Rectifier AC Input Connections | 26 |
| Nominal 100 VAC / 120 VAC / 208 VAC / 240 VAC Input, Single Phase..... | 26 |
| External Alarm, Reference, Monitoring, and Control Connections | 28 |
| General | 28 |
| IB2 (Controller Interface Board) | 28 |
| EIB (Controller Extended Interface Board) | 28 |
| NCU Controller Ethernet Connection (if required) | 31 |
| To NCU Front Panel..... | 31 |
| Load Distribution Connections | 31 |
| General | 31 |
| 582137100101, 582137100102..... | 31 |
| 582137100103, 582137100104..... | 31 |
| 582137100105, 582137100106..... | 31 |
| Input Battery Connections | 37 |
| General | 37 |
| SPECIFICATIONS..... | 38 |
| 1. System..... | 38 |
| 1.1 DC Output Ratings..... | 38 |

Vertiv™ NetSure™ 7100 Compact DC Power System

System Application Guide

| | |
|---|-----------|
| 1.2 AC Input Ratings | 38 |
| 1.3 Environmental Ratings..... | 38 |
| 1.4 Compliance Information..... | 39 |
| 1.5 IB2 and EIB (Controller Interface Board) Ratings..... | 39 |
| 2. Rectifier..... | 39 |
| 3. Controller..... | 39 |
| MECHANICAL SPECIFICATIONS | 40 |
| Overall Dimensions..... | 40 |
| 582137100101, 582137100103, 582137100105 Configured System..... | 40 |
| 582137100102, 582137100104, 582137100106 Configured System..... | 41 |
| System with Optional Wall Mount Bracket Kit, P/N 565533..... | 42 |
| Weights..... | 43 |
| RELATED DOCUMENTATION | 43 |

MAIN COMPONENTS ILLUSTRATIONS

582137100101, 52137100103, 582137100105 Configured System

582137100101, 582137100103, 582137100105

| No Covers | Low Voltage Disconnect |
|--------------|------------------------|
| 582137100101 | (2) LVLD, (1) LVBD |
| 582137100103 | No LVD |
| 582137100105 | (1) LVBD |

Three (3) 1.10" conduit knockouts provided for nominal 3/4" conduit.

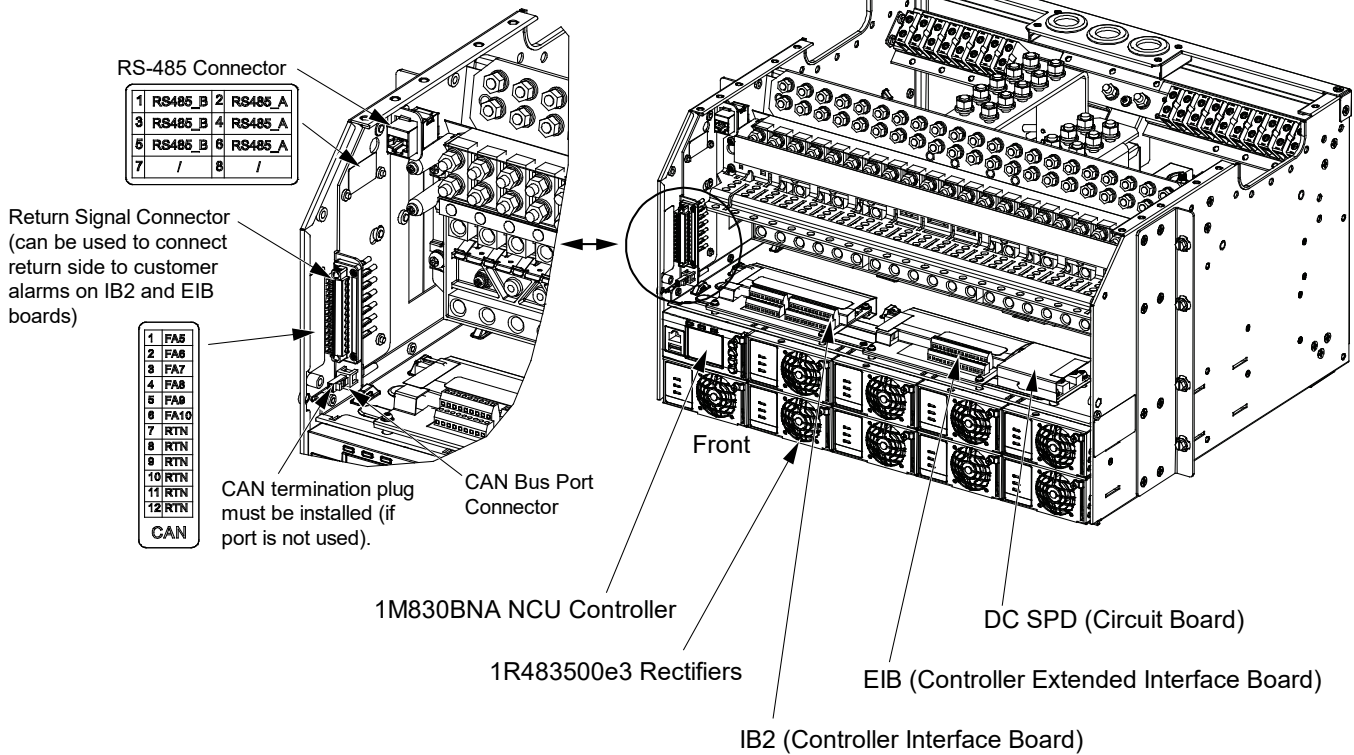

Notes:

1. The controller is not included and must be ordered separately.

Vertiv™ NetSure™ 7100 Compact DC Power System

System Application Guide

582137100102, 52137100104, 582137100106 Configured System

Three (3) 1.10" conduit knockouts provided for nominal 3/4" conduit.

582137100102, 582137100104, 582137100106

| Covers | Low Voltage Disconnect |
|--------------|------------------------|
| 582137100102 | (2) LVLD, (1) LVBD |
| 582137100104 | No LVD |
| 582137100106 | (1) LVBD |

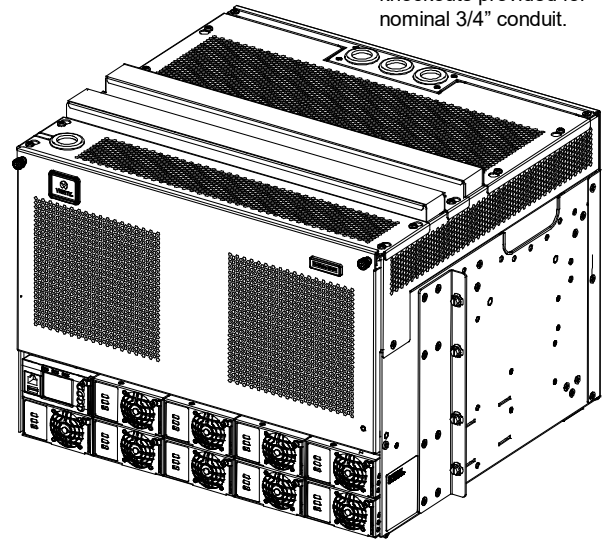

Outside covers removed in illustration for clarity only.

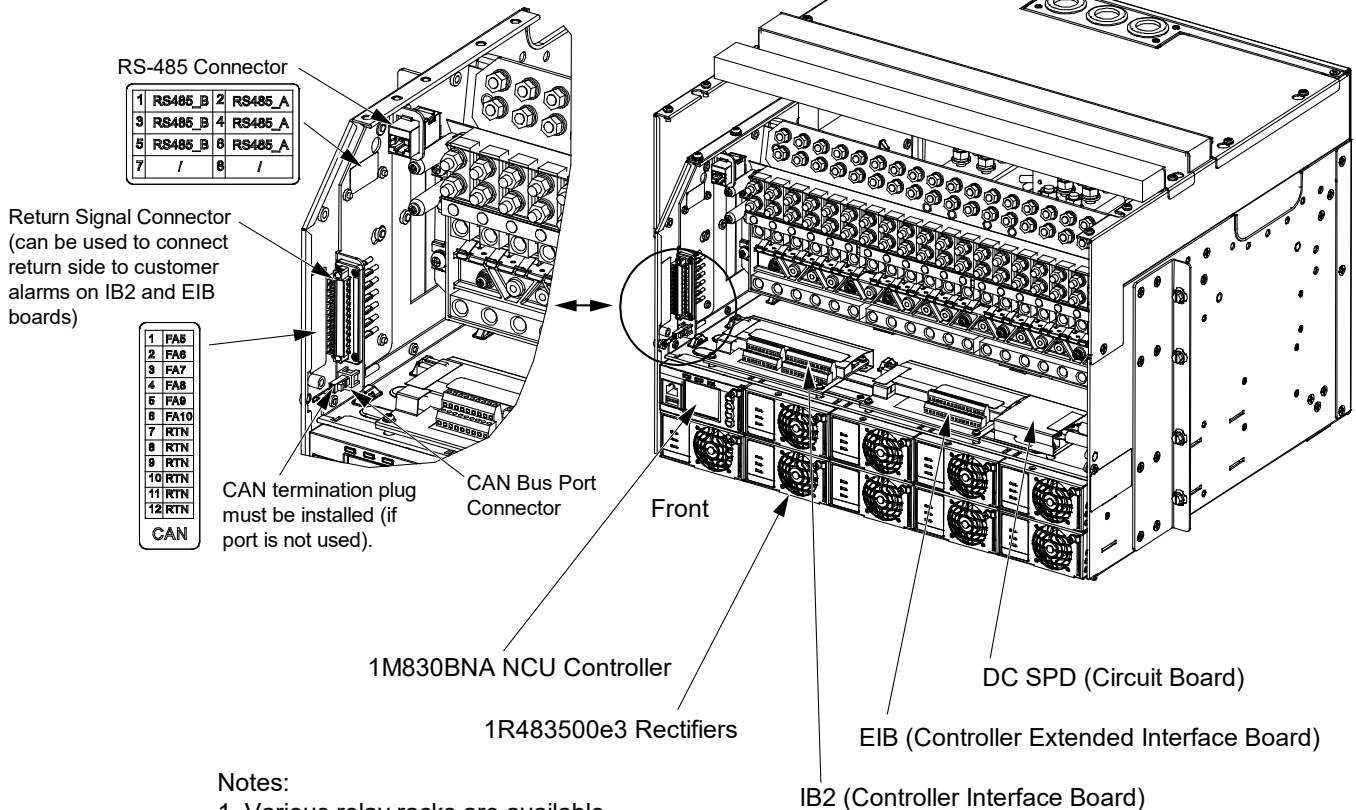

Notes:

1. Various relay racks are available.
2. The controller is not included and must be ordered separately.

Vertiv™ NetSure™ 7100 Compact DC Power System
System Application Guide

582137100101, 52137100102, 582137100103, 582137100104, 52137100105, 582137100106 Configured System

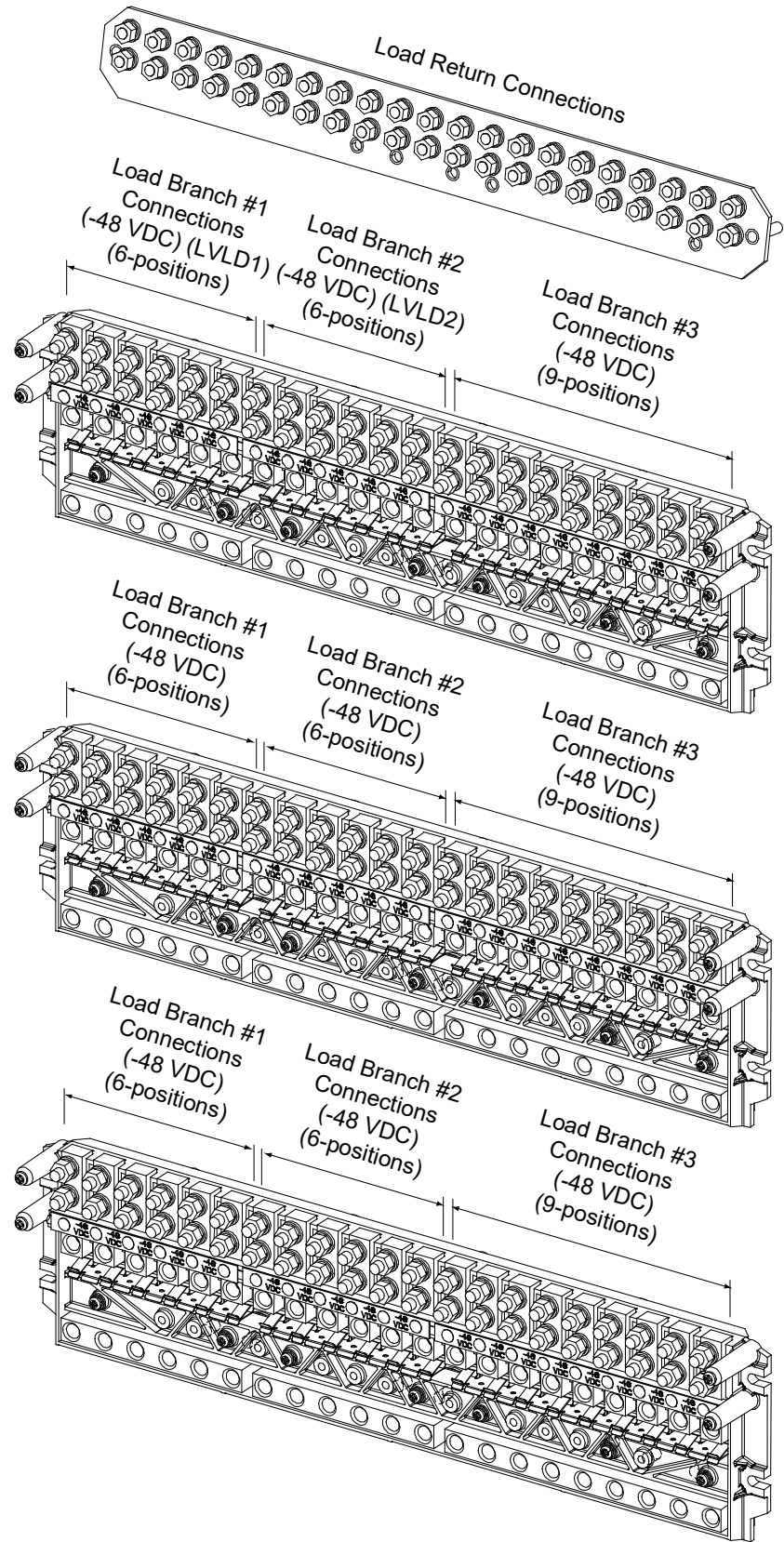

M6 Studs on 5/8" Centers
Maximum Lug Width:
0.625 inches.
Busbar Hardware:
M6 Hex Nut
M6 Lock Washer
M6 Flat Washer
Recommended Torque:
45 in-lbs.

Battery disconnects
with LVBD.

582137100101,
582137100102

DO NOT install multi-pole
devices across load branches.

Each load branch has an
individual 300 A shunt inline
with the distribution positions.

582137100103,
582137100104

Battery disconnects
with LVBD.

582137100105,
582137100106

LIST DESCRIPTIONS

Configured Systems

582137100101: Configured System

Features

- ◆ Provides a -48 VDC 500 A power system e/w (2) LVLD's and LVBD - no front door and top cover.
- ◆ This is a preconfigured power system which is orderable by specifying one List Number. See also "582137100101, 52137100103, 582137100105 Configured System" on page 5.
- ◆ 6RU high, 15.7" deep.
- ◆ Two (2) load LVD's and one (1) battery LVD.
- ◆ Includes a distribution panel with six (6) -48 VDC load distribution circuit breaker mounting positions controlled by LVLD1, six (6) -48 VDC load distribution circuit breaker mounting positions controlled by LVLD2, and nine (9) additional -48 VDC load distribution circuit breaker mounting positions. The battery bus is controlled by LVBD. Accommodates 1 A to 200 A Bullet Nose Type Circuit Breakers.
- ◆ Provides four (4) battery lug landing points on the battery busbar and five (5) battery lug landing points on the return busbar.
- ◆ Includes the IB2 controller interface board. The IB2 provides eight (8) programmable form C- relay outputs, eight (8) programmable binary inputs, and two (2) temperature inputs.
- ◆ Includes the EIB controller extended interface board. The EIB provides five (5) programmable form C- relay outputs, two (2) temperature inputs, three (3) shunt inputs (shunts must be located in the hot -48V bus), and eight (8) battery midpoint inputs.
- ◆ Includes a DC surge protection circuit board factory wired to the DC load bus.
- ◆ Includes a mounting position for an NCU controller.
- ◆ Includes nine (9) mounting position for the Spec. No. 1R483500e3 rectifier.

Restrictions

Does not have a front, top, or rear cover.

For use in an outside plant (OSP) cabinet up to 65 °C.

Maximum lug width, 0.625 inches.

See also "Restrictions" under "Bullet Nose Type Circuit Breakers" on page 18.

Ordering Notes

- 1) Order 582137100101 and the following for a configured system.
- 2) Order NCU controller P/N 1M830BNA (see page 15).
- 3) Order rectifier modules P/N 1R483500e3 as required (see page 17).
- 4) Order a blank rectifier module mounting position cover P/N SXA 110 0035/1 for each unused rectifier mounting position in the system as desired (see page 17).
- 5) Order temperature probes as required (see page 15).
- 6) Order circuit breakers as required per "Distribution Devices" starting on page 18.
- 7) Order battery and load distribution lugs, lug adapters, and lug hardware kits as required per "Standard Crimp Lugs, Special Application Crimp Lugs, and Busbar Adapter Kits and Hardware Kits" starting on page 20.

Vertiv™ NetSure™ 7100 Compact DC Power System

System Application Guide

582137100102: Configured System

Features

- ◆ Provides a -48 VDC 500 A Power System e/w (2) LVLD's and LVBD.
- ◆ This is a preconfigured power system which is orderable by specifying one List Number. See also "582137100102, 52137100104, 582137100106 Configured System" on page 6.
- ◆ 8RU high, 16.1" deep
- ◆ Two (2) load LVD's and one (1) battery LVD.
- ◆ All system components mounted in a relay rack specified when ordered.
- ◆ Includes a distribution panel with six (6) -48 VDC load distribution circuit breaker mounting positions controlled by LVLD1, six (6) -48 VDC load distribution circuit breaker mounting positions controlled by LVLD2, and nine (9) additional -48 VDC load distribution circuit breaker mounting positions. The battery bus is controlled by LVBD. Accommodates 1 A to 200 A Bullet Nose Type Circuit Breakers.
- ◆ Provides four (4) battery lug landing points on the battery busbar and five (5) battery lug landing points on the return busbar.
- ◆ Includes the IB2 controller interface board. The IB2 provides eight (8) programmable form C- relay outputs, eight (8) programmable binary inputs, and two (2) temperature inputs.
- ◆ Includes the EIB controller extended interface board. The EIB provides five (5) programmable form C- relay outputs, two (2) temperature inputs, three (3) shunt inputs (shunts must be located in the hot -48V bus), and eight (8) battery midpoint inputs.
- ◆ Includes a DC surge protection circuit board factory wired to the DC load bus.
- ◆ Includes a mounting position for an NCU controller.
- ◆ Includes nine (9) mounting position for the Spec. No. 1R483500e3 rectifier.

Restrictions

Includes a front, top, and rear cover.

For use in an environment up to 40 °C.

Maximum lug width, 0.625 inches.

See also "Restrictions" under "Bullet Nose Type Circuit Breakers" on page 18.

Ordering Notes

- 1) Order 582137100102 and the following for a configured system.
- 2) Order NCU controller P/N 1M830BNA (see page 15).
- 3) Order rectifier modules P/N 1R483500e3 as required (see page 17).
- 4) Order a blank rectifier module mounting position cover P/N SXA 110 0035/1 for each unused rectifier mounting position in the system as desired (see page 17).
- 5) Order temperature probes as required (see page 15).
- 6) Order circuit breakers as required per "Distribution Devices" starting on page 18.
- 7) Order battery and load distribution lugs, lug adapters, and lug hardware kits as required per "Standard Crimp Lugs, Special Application Crimp Lugs, and Busbar Adapter Kits and Hardware Kits" starting on page 20.
- 8) Order a relay rack as required (see page 14).

Vertiv™ NetSure™ 7100 Compact DC Power System

System Application Guide

582137100103: Configured System

Features

- ◆ Provides a -48 VDC 500 A Power System e/w no LVD's - no front door and top cover.
- ◆ This is a preconfigured power system which is orderable by specifying one List Number. See also "582137100101, 52137100103, 582137100105 Configured System" on page 5.
- ◆ 6RU high, 15.7" deep
- ◆ Does not include any LVD's.
- ◆ Includes a distribution panel with twenty-one (21) -48 VDC load distribution circuit breaker mounting positions. Accommodates 1 A to 200 A Bullet Nose Type Circuit Breakers.
- ◆ Provides four (4) battery lug landing points on the battery busbar and five (5) battery lug landing points on the return busbar.
- ◆ Includes the IB2 controller interface board. The IB2 provides eight (8) programmable form C- relay outputs, eight (8) programmable binary inputs, and two (2) temperature inputs.
- ◆ Includes the EIB controller extended interface board. The EIB provides five (5) programmable form C- relay outputs, two (2) temperature inputs, three (3) shunt inputs (shunts must be located in the hot -48V bus), and eight (8) battery midpoint inputs.
- ◆ Includes a DC surge protection circuit board factory wired to the DC load bus.
- ◆ Includes a mounting position for an NCU controller.
- ◆ Includes nine (9) mounting position for the Spec. No. 1R483500e3 rectifier.

Restrictions

Does not have a front, top, or rear cover.

For use in an outside plant (OSP) cabinet up to 65 °C.

Maximum lug width, 0.625 inches.

See also "Restrictions" under "Bullet Nose Type Circuit Breakers" on page 18.

Ordering Notes

- 1) Order 582137100103 and the following for a configured system.
- 2) Order NCU controller P/N 1M830BNA (see page 15).
- 3) Order rectifier modules P/N 1R483500e3 as required (see page 17).
- 4) Order a blank rectifier module mounting position cover P/N SXA 110 0035/1 for each unused rectifier mounting position in the system as desired (see page 17).
- 5) Order temperature probes as required (see page 15).
- 6) Order circuit breakers as required per "Distribution Devices" starting on page 18.
- 7) Order battery and load distribution lugs, lug adapters, and lug hardware kits as required per "Standard Crimp Lugs, Special Application Crimp Lugs, and Busbar Adapter Kits and Hardware Kits" starting on page 20.

Vertiv™ NetSure™ 7100 Compact DC Power System

System Application Guide

582137100104: Configured System

Features

- ◆ Provides a -48 VDC 500 A Power System e/w no LVD's.
- ◆ This is a preconfigured power system which is orderable by specifying one List Number. See also “582137100102, 52137100104, 582137100106 Configured System” on page 6.
- ◆ 8RU high, 16.1” deep
- ◆ Does not include any LVD's.
- ◆ All system components mounted in a relay rack specified when ordered.
- ◆ Includes a distribution panel with twenty-one (21) -48 VDC load distribution circuit breaker mounting positions. Accommodates 1 A to 200 A Bullet Nose Type Circuit Breakers.
- ◆ Provides four (4) battery lug landing points on the battery busbar and five (5) battery lug landing points on the return busbar.
- ◆ Includes the IB2 controller interface board. The IB2 provides eight (8) programmable form C- relay outputs, eight (8) programmable binary inputs, and two (2) temperature inputs.
- ◆ Includes the EIB controller extended interface board. The EIB provides five (5) programmable form C- relay outputs, two (2) temperature inputs, three (3) shunt inputs (shunts must be located in the hot -48V bus), and eight (8) battery midpoint inputs.
- ◆ Includes a DC surge protection circuit board factory wired to the DC load bus.
- ◆ Includes a mounting position for an NCU controller.
- ◆ Includes nine (9) mounting position for the Spec. No. 1R483500e3 rectifier.

Restrictions

Includes a front, top, and rear cover.

For use in an environment up to 40 °C.

Maximum lug width, 0.625 inches.

See also “Restrictions” under “Bullet Nose Type Circuit Breakers” on page 18.

Ordering Notes

- 1) Order 582137100104 and the following for a configured system.
- 2) Order NCU controller P/N 1M830BNA (see page 15).
- 3) Order rectifier modules P/N 1R483500e3 as required (see page 17).
- 4) Order a blank rectifier module mounting position cover P/N SXA 110 0035/1 for each unused rectifier mounting position in the system as desired (see page 17).
- 5) Order temperature probes as required (see page 15).
- 6) Order circuit breakers as required per “Distribution Devices” starting on page 18.
- 7) Order battery and load distribution lugs, lug adapters, and lug hardware kits as required per “Standard Crimp Lugs, Special Application Crimp Lugs, and Busbar Adapter Kits and Hardware Kits” starting on page 20.
- 8) Order a relay rack as required (see page 14).

Vertiv™ NetSure™ 7100 Compact DC Power System

System Application Guide

582137100105: Configured System

Features

- ◆ Provides a -48 VDC 500 A Power System e/w LVBD - no front door and top cover.
- ◆ This is a preconfigured power system which is orderable by specifying one List Number. See also “582137100101, 52137100103, 582137100105 Configured System” on page 5.
- ◆ 6RU high, 15.7” deep
- ◆ One (1) battery LVD.
- ◆ Includes a distribution panel with twenty-one (21) -48 VDC load distribution circuit breaker mounting positions. The battery bus is controlled by LVBD.
Accommodates 1 A to 200 A Bullet Nose Type Circuit Breakers.
- ◆ Provides four (4) battery lug landing points on the battery busbar and five (5) battery lug landing points on the return busbar.
- ◆ Includes the IB2 controller interface board.
The IB2 provides eight (8) programmable form C- relay outputs, eight (8) programmable binary inputs, and two (2) temperature inputs.
- ◆ Includes the EIB controller extended interface board.
The EIB provides five (5) programmable form C- relay outputs, two (2) temperature inputs, three (3) shunt inputs (shunts must be located in the hot -48V bus), and eight (8) battery midpoint inputs.
- ◆ Includes a DC surge protection circuit board factory wired to the DC load bus.
- ◆ Includes a mounting position for an NCU controller.
- ◆ Includes nine (9) mounting position for the Spec. No. 1R483500e3 rectifier.

Restrictions

Does not have a front, top, or rear cover.

For use in an outside plant (OSP) cabinet up to 65 °C.

Maximum lug width, 0.625 inches.

See also “Restrictions” under “Bullet Nose Type Circuit Breakers” on page 18.

Ordering Notes

- 1) Order 582137100105 and the following for a configured system.
- 2) Order NCU controller P/N 1M830BNA (see page 15).
- 3) Order rectifier modules P/N 1R483500e3 as required (see page 17).
- 4) Order a blank rectifier module mounting position cover P/N SXA 110 0035/1 for each unused rectifier mounting position in the system as desired (see page 17).
- 5) Order temperature probes as required (see page 15).
- 6) Order circuit breakers as required per “Distribution Devices” starting on page 18.
- 7) Order battery and load distribution lugs, lug adapters, and lug hardware kits as required per “Standard Crimp Lugs, Special Application Crimp Lugs, and Busbar Adapter Kits and Hardware Kits” starting on page 20.

Vertiv™ NetSure™ 7100 Compact DC Power System

System Application Guide

582137100106: Configured System

Features

- ◆ Provides a -48VDC 500A Power System e/w LVBD.
- ◆ This is a preconfigured power system which is orderable by specifying one List Number. See also “582137100102, 52137100104, 582137100106 Configured System” on page 6.
- ◆ 8RU high, 16.1” deep
- ◆ One (1) battery LVD.
- ◆ All system components mounted in a relay rack specified when ordered.
- ◆ Includes a distribution panel with twenty-one (21) -48 VDC load distribution circuit breaker mounting positions. The battery bus is controlled by LVBD.
Accommodates 1 A to 200 A Bullet Nose Type Circuit Breakers.
- ◆ Provides four (4) battery lug landing points on the battery busbar and five (5) battery lug landing points on the return busbar.
- ◆ Includes the IB2 controller interface board.
The IB2 provides eight (8) programmable form C- relay outputs, eight (8) programmable binary inputs, and two (2) temperature inputs.
- ◆ Includes the EIB controller extended interface board.
The EIB provides five (5) programmable form C- relay outputs, two (2) temperature inputs, three (3) shunt inputs (shunts must be located in the hot -48V bus), and eight (8) battery midpoint inputs.
- ◆ Includes a DC surge protection circuit board factory wired to the DC load bus.
- ◆ Includes a mounting position for an NCU controller.
- ◆ Includes nine (9) mounting position for the Spec. No. 1R483500e3 rectifier.

Restrictions

Includes a front, top, and rear cover.

For use in an environment up to 40 °C.

Maximum lug width, 0.625 inches.

See also “Restrictions” under “Bullet Nose Type Circuit Breakers” on page 18.

Ordering Notes

- 1) Order 582137100106 and the following for a configured system.
- 2) Order NCU controller P/N 1M830BNA (see page 15).
- 3) Order rectifier modules P/N 1R483500e3 as required (see page 17).
- 4) Order a blank rectifier module mounting position cover P/N SXA 110 0035/1 for each unused rectifier mounting position in the system as desired (see page 17).
- 5) Order temperature probes as required (see page 15).
- 6) Order circuit breakers as required per “Distribution Devices” starting on page 18.
- 7) Order battery and load distribution lugs, lug adapters, and lug hardware kits as required per “Standard Crimp Lugs, Special Application Crimp Lugs, and Busbar Adapter Kits and Hardware Kits” starting on page 20.
- 8) Order a relay rack as required (see page 14).

ACCESSORY DESCRIPTIONS

Relay Racks

Features

- ◆ Relay racks are 19" or 23" (see Table 2) standard mounting.

Ordering Notes

- 1) Order from relay racks listed in Table 2.

| Part Number | Size | Available Mounting Positions (1RU = 1-3/4") | Notes |
|------------------------|----------------------------|---|---------------------|
| 23" Relay Racks | | | |
| 559817 | 51.906"H x 24.376"W x 15"D | 28RU | Welded |
| 559819 | 84.000"H x 25.000"W x 15"D | 45RU | Seismic (Note 1) |
| 559818 | 72.000"H x 24.375"W x 15"D | 37RU | Welded |
| 562353 | 84.000"H x 25.800"W x 18"D | 45RU | Seismic (Note 1, 2) |
| 559820 | 84.000"H x 24.375"W x 15"D | 45RU | Welded |
| 559821 | 90.000"H x 24.375"W x 15"D | 48RU | Welded |
| 559822 | 96.000"H x 24.375"W x 15"D | 51RU | Welded |
| 19" Relay Racks | | | |
| 559824 | 84.000"H x 21.000"W x 15"D | 45RU | Welded |
| 559823 | 84.000"H x 20.375"W x 15"D | 45RU | Seismic (Note 1) |

Note 1: Complies with Bellcore Seismic Zone 4 requirements.

Note 2: For power systems mounted in relay racks with more than one battery tray.

Table 2
Available Relay Racks

19" to 23" Wide Relay Rack Mounting Bracket Kit, P/N 553630

Features

- ◆ Allows mounting the system in a 23" wide relay rack.
- ◆ Mounting hardware included.
- ◆ Field installed.

Ordering Notes

- 1) Order P/N 553630 as required.

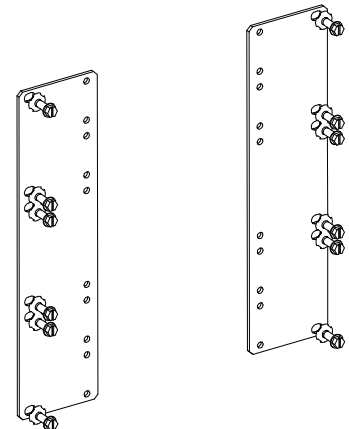

Optional Wall Mounting Bracket Kit, P/N 565533

Features

- ◆ Allows for mounting the system horizontally on a wall.
- ◆ See “System with Optional Wall Mount Bracket Kit, P/N 565533” on page 42 for mounting dimensions.

Restrictions

For horizontal mount only.

Customer must supply mounting fasteners for securing the wall mount bracket to the wall.

Ordering Notes

- 1) Order by P/N 565533 as required.

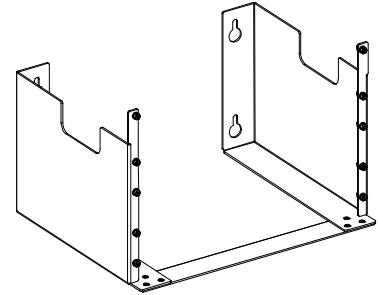

NCU (NetSure Control Unit) Controller, P/N 1M830BNA

Features

- ◆ NCU Controller, Model M830B (Spec. No. 1M830BNA).
- ◆ Factory programmed with the configuration file required for the system configuration ordered.

Note: For custom NCU configurations, contact Vertiv.

Restrictions

Only one (1) controller per power system is required.

Ordering Notes

- 1) Order one (1) NCU controller per power system.
582137100101 and 582137100102, order P/N 1M830BNA10009548.
582137100103 and 582137100104, order P/N 1M830BNA10008994.
582137100105 and 582137100106, order P/N 1M830BNA10008996.

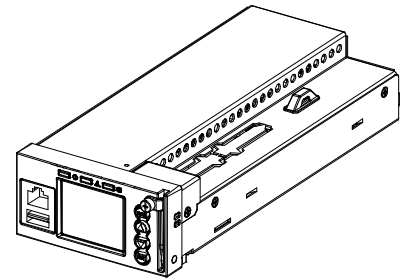

Optional Temperature Probes

Features

- ◆ Up to two (2) temperature probes can be connected to the IB2 (Controller Interface Board). Up to two (2) additional temperature probes can be connected to the EIB (Controller Extended Interface Board). Any combination of the four (4) temperature probes can be programmed to monitor ambient temperature and/or battery temperature. A temperature probe set to monitor battery temperature can also be used for the rectifier battery charge temperature compensation feature, or the battery charge temperature compensation feature can be programmed to use the average or highest value of all battery temperature probes. The battery charge temperature compensation feature allows the controller to automatically increase or decrease the output voltage of the system to maintain battery float current as battery temperature decreases or increases, respectively. Battery life can be extended when an optimum charge voltage to the battery with respect to temperature is maintained. A temperature probe set to monitor battery temperature can also be used for the BTRM (Battery Thermal Runaway Management) feature. The BTRM feature lowers output voltage when a high temperature condition exists to control against battery thermal runaway.
- ◆ The temperature sensor end of the probe contains a tab with a 5/16” clearance hole for mounting.
- ◆ Temperature probes can also be used with the optional “SM-Temp Temperature Concentrator”. See page 16.

Restrictions

A temperature probe programmed to monitor battery temperature should be mounted on the negative post of a battery cell to sense battery temperature. A temperature probe used for battery charge temperature compensation and/or BTRM (Battery Thermal Runaway Management) should also be mounted on the negative post of a battery cell. A temperature probe programmed to monitor ambient temperature should be mounted in a convenient location, away from direct sources of heat or cold.

Vertiv™ NetSure™ 7100 Compact DC Power System

System Application Guide

Ordering Notes

- 1) Order temperature probes as required. Note that each temperature probe consists of two pieces which plug together to make a complete probe (see the following illustration). For a complete temperature probe, order one (1) P/N 552992 (10.3 meters) or one (1) P/N 556155 (3.3 meters). If additional length is required, order temperature probe extension cable P/N 04119122 (10 meters).
- 2) If more probes are desired, order one or more SM-Temp Temperature Concentrator, P/N 547490. See “Optional SM-Temp Temperature Concentrator” on page 16.

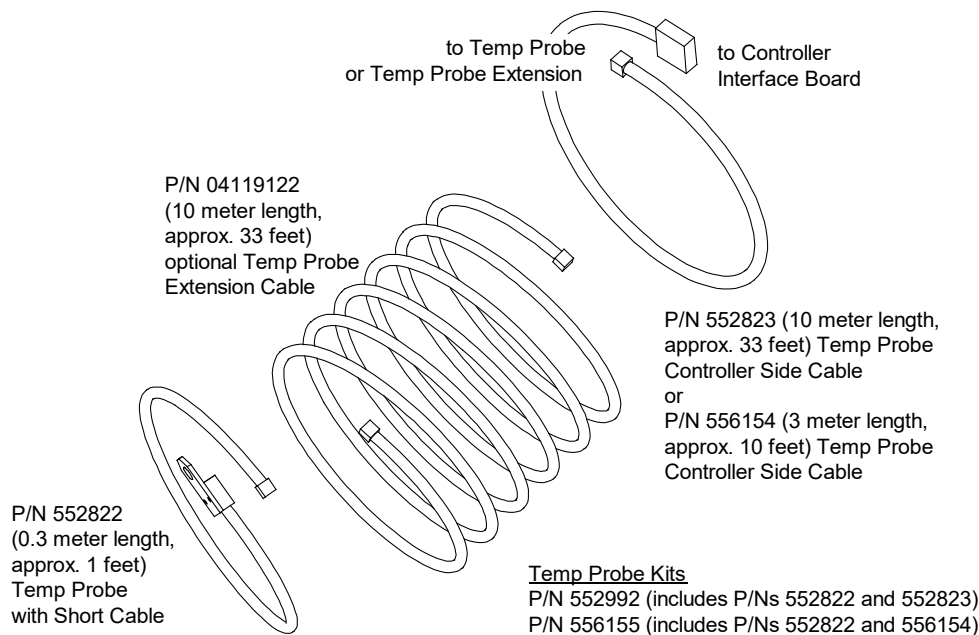

Optional SM-Temp Temperature Concentrator

SM-Temp Temperature Concentrator, P/N 547490

Features

- ◆ Allows for multiple temperature probes to be used for ambient temperature monitoring, battery temperature monitoring, temperature compensation, and/or BTRM (Battery Thermal Runaway Management).
- ◆ Provides (8) temperature probe inputs per SM-Temp unit.
- ◆ Can cascade up to (8) SM-Temp units, connecting up to sixty-four (64) temperature probes.
- ◆ The SM-Temp Concentrator is connected at the end of the NCU CAN bus. Via the CAN Bus, the NCU reads each temperature probe from each SM-Temp Concentrator.
- ◆ Refer to the SM-Temp Temperature Concentrator Instructions (UM547490) for more information.

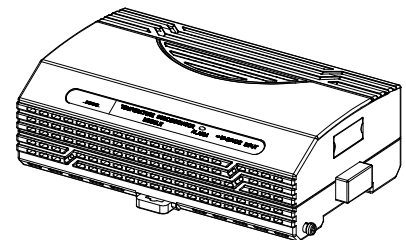

Ordering Notes

- 1) Order SM-Temp Temperature Concentrator, P/N 547490, as required.
- 2) Order up to (8) temperature probes for each concentrator. See “Optional Temperature Probes” on page 15.
- 3) Order one (1) SM-Temp CAN Bus Interface Cable (P/N 562868) to connect the SM-Temp into the controller’s CAN bus. See “SM-Temp CAN Bus Interface Cable, P/N 562868” on page 17.
- 4) Order SM-Temp jumpers (P/N 552888) to interconnect SM-Temp units, as required. See “SM-Temp Jumpers, P/N 552888” on page 17.

Vertiv™ NetSure™ 7100 Compact DC Power System

System Application Guide

SM-Temp CAN Bus Interface Cable, P/N 562868

Features

- ◆ Used to connect the SM-Temp into the controller's CAN bus. Provides approximately 33' of 24 AWG twisted pair cable terminated at one end with an RJ-45 connector and left unterminated at the other end with the W/O and O wires stripped. The W/O (CAN_L) and O (CAN_H) wires are connected to the SM-Temp Concentrator. The RJ-45 connector plugs into the system's CAN port connector.

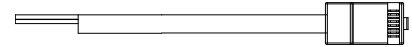

Ordering Notes

- 1) Order P/N 562868 as required.

SM-Temp Jumpers, P/N 552888

Features

- ◆ Provides 20' of 18 AWG solid red / black twisted pair cable and three (3) wire splices for connecting the CAN bus of multiple SM-Temp modules together.

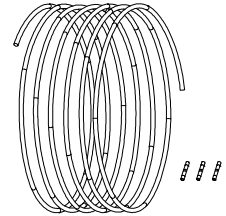

Ordering Notes

- 1) Order P/N 552888 as required.

Rectifier Module, P/N 1R483500e3

Features

- ◆ Model R48-3500e3 (Spec. No. 1R483500e3) 3500 W / -48 VDC rectifier module.
- ◆ Refer to the Rectifier Instructions (UM1R483500e3) for more information.

Ordering Notes

- 1) Order by P/N 1R483500e3 as required. Each power system holds up to nine (9) rectifier modules.

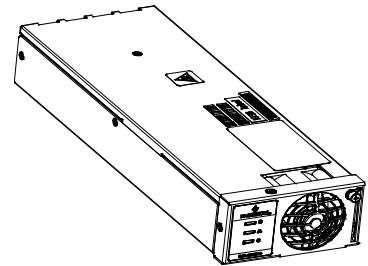

Module Mounting Position Blank Cover Panel, P/N SXA 110 0035/1

Features

- ◆ Covers one (1) unused module mounting position.

Ordering Notes

- 1) Order by P/N SXA 110 0035/1 as required. Order a module mounting position blank cover panel for each empty module mounting position in the system, as desired.

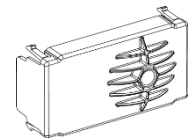

Distribution Devices

Bullet Nose Type Circuit Breakers

Features

- ◆ Each circuit breaker (as listed in Table 3) plugs into one or two distribution panel mounting position(s).

Restrictions

125 A to 200 A circuit breakers are 2-pole devices (occupy two mounting positions).

Load should not exceed 80% of device rating.

Maximum current per load branch should never exceed 190 A for list 102, 104 and 106; and never exceed 133 A for list 101, 103 and 105.

The system load current shall be not more than its rating.

DO NOT install multi-pole devices across load branches.

Ordering Notes

- 1) Order circuit breakers as required per Table 3.
- 2) See Table 10 for recommended battery and load distribution wire sizes and lugs.
- 3) When ordering 2-pole devices, busbar lug adapter kit P/N 563191 may be ordered per device. See Table 7. Other options are shown in Table 6.

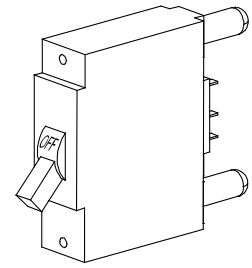

Toggle Handle
Bullet Nose Circuit Breaker

Bullet Nose Bypass Busbar, P/N 535015

Features

- ◆ Replaces a bullet nose circuit breaker when a protective or disconnect device is not required.

Ordering Notes

- 1) Order by P/N 535015 as required.

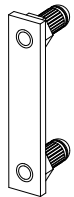

Vertiv™ NetSure™ 7100 Compact DC Power System
System Application Guide

| Ampere Rating | Number of Poles | Number of Mounting Positions Required | Part Number | |
|---|-----------------|---------------------------------------|---|--|
| | | | Electrical Trip ¹ (White Handle) | Electrical/ Mechanical Trip ² (Black Handle) |
| 1 | 1 | 1 | 102272 | 101596 |
| 3 | 1 | 1 | 102273 | 101597 |
| 5 | 1 | 1 | 102274 | 101598 |
| 10 | 1 | 1 | 102275 | 101599 |
| 15 | 1 | 1 | 102276 | 101600 |
| 20 | 1 | 1 | 102277 | 101601 |
| 25 | 1 | 1 | 102278 | 101602 |
| 30 | 1 | 1 | 102279 | 101603 |
| 35 | 1 | 1 | 102280 | 101604 |
| 40 | 1 | 1 | 102281 | 101605 |
| 45 | 1 | 1 | 121998 | 121997 |
| 50 | 1 | 1 | 102282 | 101606 |
| 60 | 1 | 1 | 102283 | 101607 |
| 70 | 1 | 1 | 102284 | 101608 |
| 75 | 1 | 1 | 102285 | 101609 |
| 80 | 1 | 1 | 121996 | 121995 |
| 90 | 1 | 1 ⁽³⁾ | 138887 | 138888 |
| 100 | 1 | 1 ⁽³⁾ | 102286 | 101610 |
| 125 | 2 | 2 ⁽³⁾ | 516991 | 516838 |
| 150 | 2 | 2 ⁽³⁾ | 516993 | 516839 |
| 175 | 2 | 2 ⁽³⁾ | 144883 | 144884 |
| 200 | 2 | 2 ⁽³⁾ | 121831 | 121832 |
| See Table 10 for recommended battery and load distribution wire sizes and lugs. | | | | |
| When ordering 2-pole devices, busbar lug adapter kit P/N 563191 may be ordered per device. See Table 7. Other options are shown in Table 6. | | | | |

Circuit Breaker Alarm Operation:

- ¹ Provides an alarm during an electrical trip condition only.
- ² Provides an alarm during an electrical or manual trip condition.
- ³ The circuit breaker physically requires the listed number of mounting positions. Refer to “Restrictions” under “Bullet Nose Type Circuit Breakers” on page 18 for any required empty mounting positions.

Note: *Electrical Trip only circuit breakers are not typically used for battery disconnect circuit breakers.*

Table 3
Toggle Handle Bullet Nose Type Circuit Breakers

Standard Crimp Lugs, Special Application Crimp Lugs, and Busbar Adapter Kits and Hardware Kits

Standard Crimp Lugs

Refer to Table 4 and Table 5.

| Lead Size | Part Number |
|-----------|-------------|
| 14-10 AWG | 245342300 |
| 8 AWG | 245390200 |
| 6 AWG | 245346700 |
| 4 AWG | 245346800 |
| 2 AWG | 245346900 |

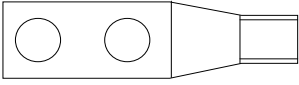

Lugs should be crimped per lug manufacturer’s specifications.

Table 4
Crimp Lug
Two-Hole, 1/4” Bolt Clearance Hole, 5/8” Centers

| Lead Size | Part Number |
|-----------|-------------|
| 6 AWG | 245349900 |
| 4 AWG | 245350000 |
| 2 AWG | 245348200 |
| 1/0 AWG | 245347100 |
| 2/0 AWG | 245347200 |
| 3/0 AWG | 245347300 |
| 4/0 AWG | 245347400 |
| 250 kcmil | 245347500 |
| 300 kcmil | 245347600 |
| 350 kcmil | 245347700 |
| 400 kcmil | 245347800 |
| 500 kcmil | 245347900 |
| 600 kcmil | 245348000 |
| 750 kcmil | 245348100 |

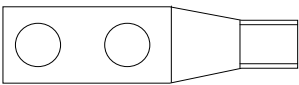

Lugs should be crimped per lug manufacturer’s specifications.

Table 5
Crimp Lug
Two-Hole, 3/8” Bolt Clearance Hole, 1” Centers

Vertiv™ NetSure™ 7100 Compact DC Power System

System Application Guide

Special Application Crimp Lug / Strap Combination, Busbar Lug Adapters, and Hardware Kits

Features

- ◆ See Table 6 and Table 7 for part numbers and descriptions of available items.

Restrictions

See note in Table 6.

Ordering Notes

- 1) Order by part number from Table 6 and Table 7 as required.

| Lead Size | Part Number | Description |
|-----------|-------------|---|
| 1/0 AWG | 245393500 | <p>Special Application Crimp Lug / Strap Combination: Straps two circuit breaker wiring positions together, and provides a crimp-type lug which allows distribution wiring up to 350 kcmil size (maximum size of wire to be connected to a single position is 2 AWG). Designed for use with 125 A and larger bullet nose-type circuit breakers, which require at least two mounting positions.</p> <p>Note: <i>If used with bullet nose-type circuit breakers smaller than 125 A, an empty mounting position is required adjacent to the distribution device.</i></p> |
| 2/0 AWG | 245393600 | |
| 3/0 AWG | 245393700 | |
| 4/0 AWG | 245393800 | |
| 250 kcmil | 514872 | |
| 350 kcmil | 514873 | |

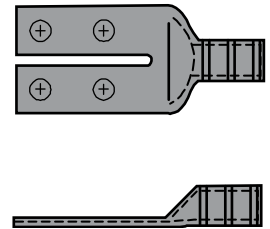

Note: For top exit cables off the return load bar in front, the lug will protrude beyond the plane of the distribution cabinet top surface for 582137100101, 582137100103, and 582137100105.

Lugs should be crimped per lug manufacturer's specifications.

Table 6
Special Application Crimp Lug / Strap Combination
(Two-Hole Lug, 1/4" Bolt Clearance Hole, 5/8" Centers)

Vertiv™ NetSure™ 7100 Compact DC Power System

System Application Guide

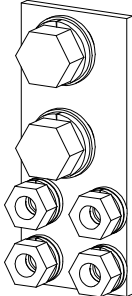
| Part Number | Description | |
|-------------|---|---|
| 563191 | <p>Busbar Lug Adapter Kit: Includes one (1) busbar that mounts on the two lug landing positions of either of the following:</p> <ul style="list-style-type: none"> • a 125 A, 150 A, or 200 A bullet nose circuit breaker. • two landings of the associated ground return bar. <p>This busbar provides a landing for one standard two-hole lug having 3/8" bolt clearance holes on 1" centers.</p> <p>Lug mounting hardware is included. Discard 1/4" hardware.</p> <p>Order two (2) Part No. 563191 per 125 A, 150 A, and 200 A bullet nose circuit breaker ordered, as desired.</p> <p>Restriction: This busbar is intended for field installation only of customer wiring exiting the top of the distribution unit.</p> |  |

Busbar lug adapter kits include hardware shown.

Unless otherwise specified, busbar lug adapter kits are factory installed when ordered with system.

Table 7
Busbar Lug Adapter and Hardware Kits

User Replaceable Components

Ordering Notes

- 1) Refer to Table 8.

| Item | Part Number |
|---|--|
| Rectifier Module | 1R483500e3 |
| NCU Controller | 1M830BNA10009548 (582137100101 and 582137100102) 1M830BNA10008994 (582137100103 and 582137100104) 1M830BNA10008996 (582137100105 and 582137100106) |
| Controller IB2 Interface Board | MA4C5U31 |
| Controller EIB Extended Interface Board | MA455U41 |

Table 8
Replaceable Assemblies

RECOMMENDED WIRE SIZES, BRANCH CIRCUIT PROTECTION, CRIMP LUGS, AND WIRING ILLUSTRATIONS

Relay Rack / Equipment Cabinet Frame Grounding Requirements

For relay rack / equipment cabinet grounding requirements, refer to the current edition of the American National Standards Institute (ANSI) approved National Fire Protection Association's (NFPA) National Electrical Code (NEC), applicable local codes, and your specific site requirements.

A customer's grounding network lead can be attached to the top of each relay rack. Provision is made for installing a lead with a two-hole lug that has 1/4" bolt clearance holes on 5/8" centers. Refer to Table 4 for lug selection.

System Shelf and Wall Mount Bracket Frame Grounding Connection

A frame ground stud is located inside the system shelf (see Figure 1 and Figure 2). For system shelf and wall mount bracket frame grounding requirements, refer to the current edition of the American National Standards Institute (ANSI) approved National Fire Protection Association's (NFPA) National Electrical Code (NEC), applicable local codes, and your specific site requirements.

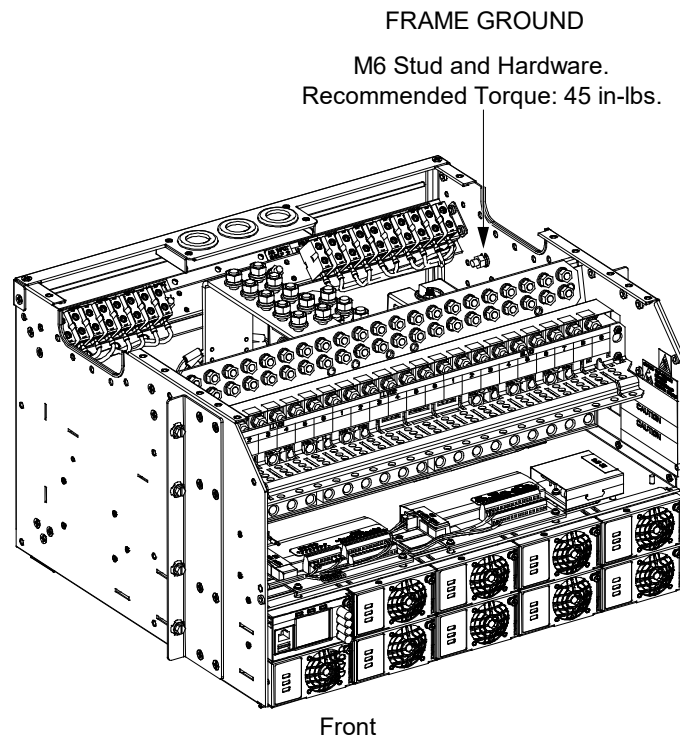

Figure 1

System Shelf and Wall Mount Bracket Frame Grounding Connection Point (582137100101, 582137100103, 582137100105)

Vertiv™ NetSure™ 7100 Compact DC Power System

System Application Guide

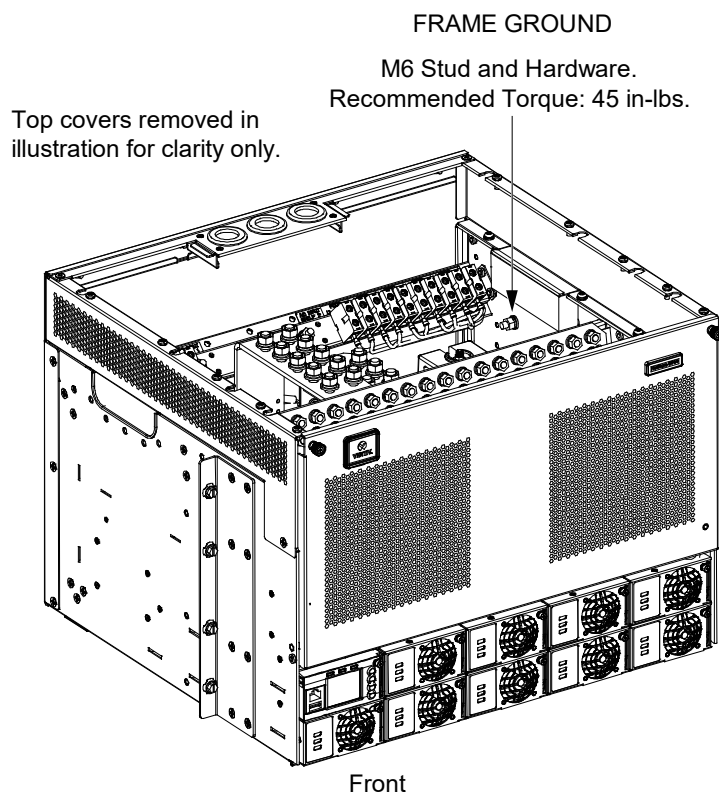

Figure 2

System Shelf and Wall Mount Bracket Frame Grounding Connection Point (582137100102, 582137100104, 582137100106)

Central Office Grounding Connection

Landing points are provided on the battery return bus for a central office ground lead (see Figure 3). For central office grounding requirements, refer to the current edition of the American National Standards Institute (ANSI) approved National Fire Protection Association's (NFPA) National Electrical Code (NEC), applicable local codes, and your specific site requirements.

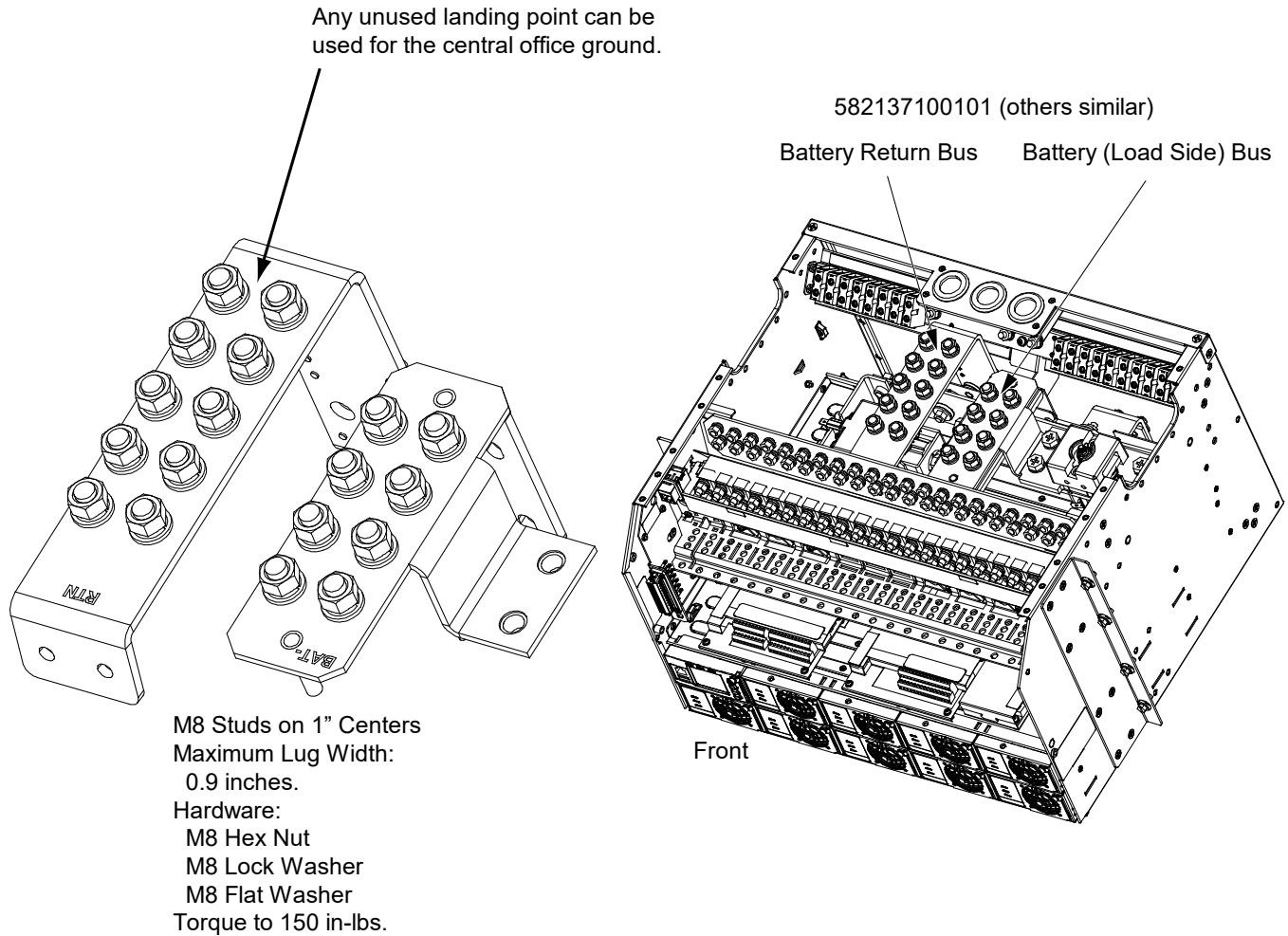

Figure 3
Central Office Ground Connections

Vertiv™ NetSure™ 7100 Compact DC Power System

System Application Guide

Rectifier AC Input Connections

Nominal 100 VAC / 120 VAC / 208 VAC / 240 VAC Input, Single Phase

Refer to Table 9 for recommended wire sizes and branch circuit protection.

Refer to Figure 4 for an illustration.

| Rectifier AC Input | | | | |
|---|------------------------------|---------------------------------------|----------------------------------|-----------------------------|
| Connection Points for Individual Rectifier Module AC Input Branch Circuits are Provided (One AC Input Branch Circuit per Rectifier Module, Nine AC Input Branch Circuits per System) | | | | |
| Input Voltage | Input Current ⁽⁵⁾ | Overcurrent Protection ⁽¹⁾ | 40 °C Ambient Temperature | |
| | | | Wire Size ^{(3) (4) (6)} | Conduit Size ⁽⁷⁾ |
| 100 VAC | 18.8 A | 25 A ⁽²⁾ | 10 AWG | 3/4" |
| 120 VAC | 19.8 A | 25 A ⁽²⁾ | 10 AWG | 3/4" |
| 208 VAC | 17.9 A | 25 A ⁽²⁾ | 10 AWG | 3/4" |
| 240 VAC | 15.5 A | 20 A | 12 AWG | 1/2" |

- ¹ The AC input branch circuit protective device should be of the time-delay or high inrush type.
- ² Maximum over current protection device is 30 A @ 40 °C.
- ³ Wire sizes based on recommendations of the American National Standards Institute (ANSI) approved National Fire Protection Association's (NFPA) National Electrical Code (NEC). Table 310.15 (B) (16) for copper wire at 90 °C conductor temperature. For operation in countries where the NEC is not recognized, follow applicable codes.
- ⁴ Equipment grounding conductors must be provided with the AC input conductors supplied to the assembly. Frame ground terminals must be connected to earth ground, not power system neutral. Equipment grounding conductor size based on recommendations of the NEC Table 250-122 for copper wire. If aluminum or copper clad aluminum grounding conductor is used, refer to Table 250-122 for increased conductor size. For operation in countries where the NEC is not recognized, follow applicable codes.
- ⁵ Input current based on R48-3500e3 rectifier module.
- ⁶ THHN 90°C Wire.
- ⁷ Three (3) rectifiers (6 current and 1 ground wire) per conduit.

Table 9
Recommended AC Input Branch Circuit Protection and Wire Size

RECTIFIER AC INPUT
1 FEED PER 1 RECTIFIER
100 VAC / 120 VAC / 208 VAC / 240 VAC
50 Hz / 60 Hz, SINGLE PHASE

| | | | | | | | | | | | | | | | | | | | | | |
|------|------|------|------|------|------|------|------|------------------|------|------------------|------|------|------|------|------|------|------|------|------|------|------|
| PCU1 | | PCU2 | | PCU3 | | PCU4 | | AC INPUT SHELF 1 | | AC INPUT SHELF 2 | | PCU5 | | PCU6 | | PCU7 | | PCU8 | | PCU9 | |
| L1 | L2/N | L1 | L2/N | L1 | L2/N | L1 | L2/N | L1 | L2/N | L1 | L2/N | L1 | L2/N | L1 | L2/N | L1 | L2/N | L1 | L2/N | L1 | L2/N |

RECTIFIER MODULE
AC INPUT SHELF 1

FRAME GROUND

RECTIFIER MODULE
AC INPUT SHELF 1

Wire Size Capacity:
20 AWG to 6 AWG.
Recommended Torque:
20 in-lbs.

Three (3) M6 x 15 mm Studs and Hardware.
Recommended Torque: 45 in-lbs.

Wire Size Capacity:
20 AWG to 6 AWG.
Recommended Torque:
20 in-lbs.

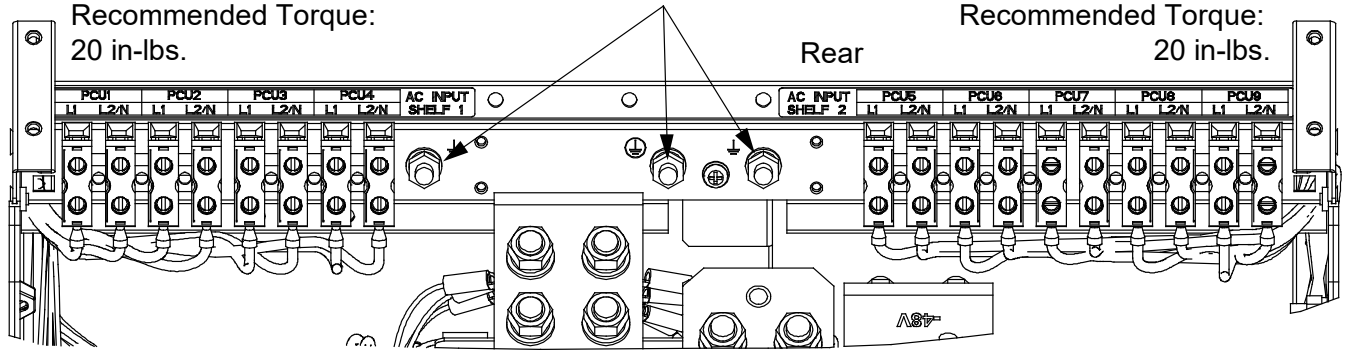

Top View
Three (3) 1.10" conduit knockouts
provided for nominal 3/4" conduit.

Line to Line:
Connect Line 1 to L1.
Connect Line 2 to L2.

Line to Neutral
Connect Line to L1.
Connect Neutral to N.

Covers (if furnished)
not shown.

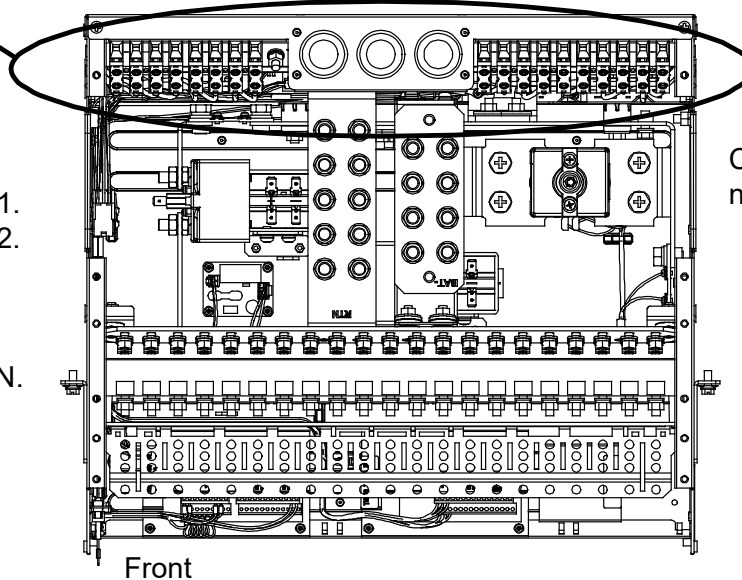

Rectifier modules are numbered left
to right as viewed from the front.

Figure 4
AC Input and Frame Ground Connections

Vertiv™ NetSure™ 7100 Compact DC Power System

System Application Guide

External Alarm, Reference, Monitoring, and Control Connections

General

Recommended wire size is 22 AWG for loop lengths up to 200 ft. and 18 AWG to 20 AWG for loop lengths over 200 ft.

Refer to Figure 5.

IB2 (Controller Interface Board)

Refer to Figure 6.

EIB (Controller Extended Interface Board)

Refer to Figure 7.

582137100101 Shown, others similar

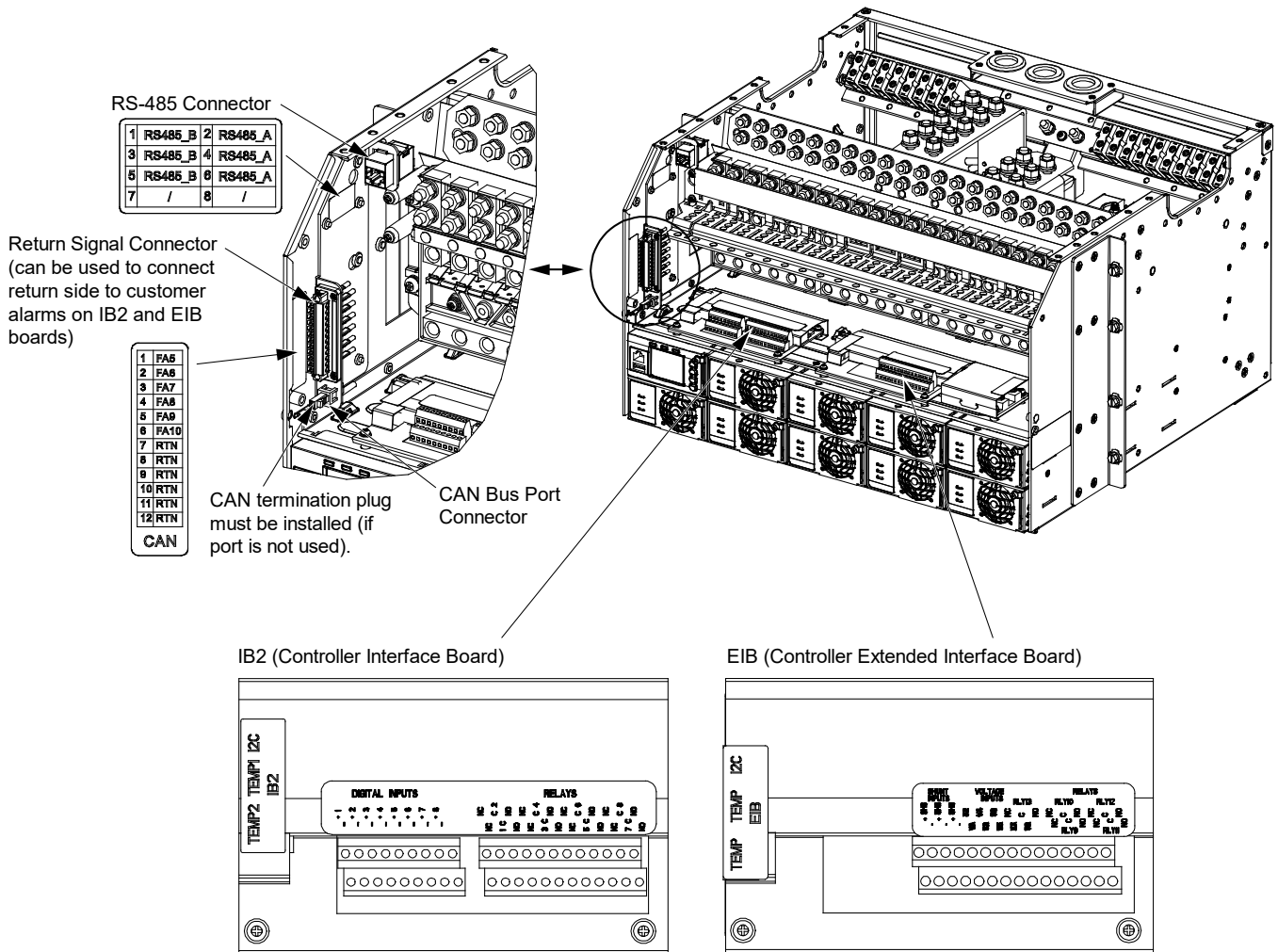

Figure 5
External Alarm, Reference, Monitoring, and Control Connections Locations

Vertiv™ NetSure™ 7100 Compact DC Power System

System Application Guide

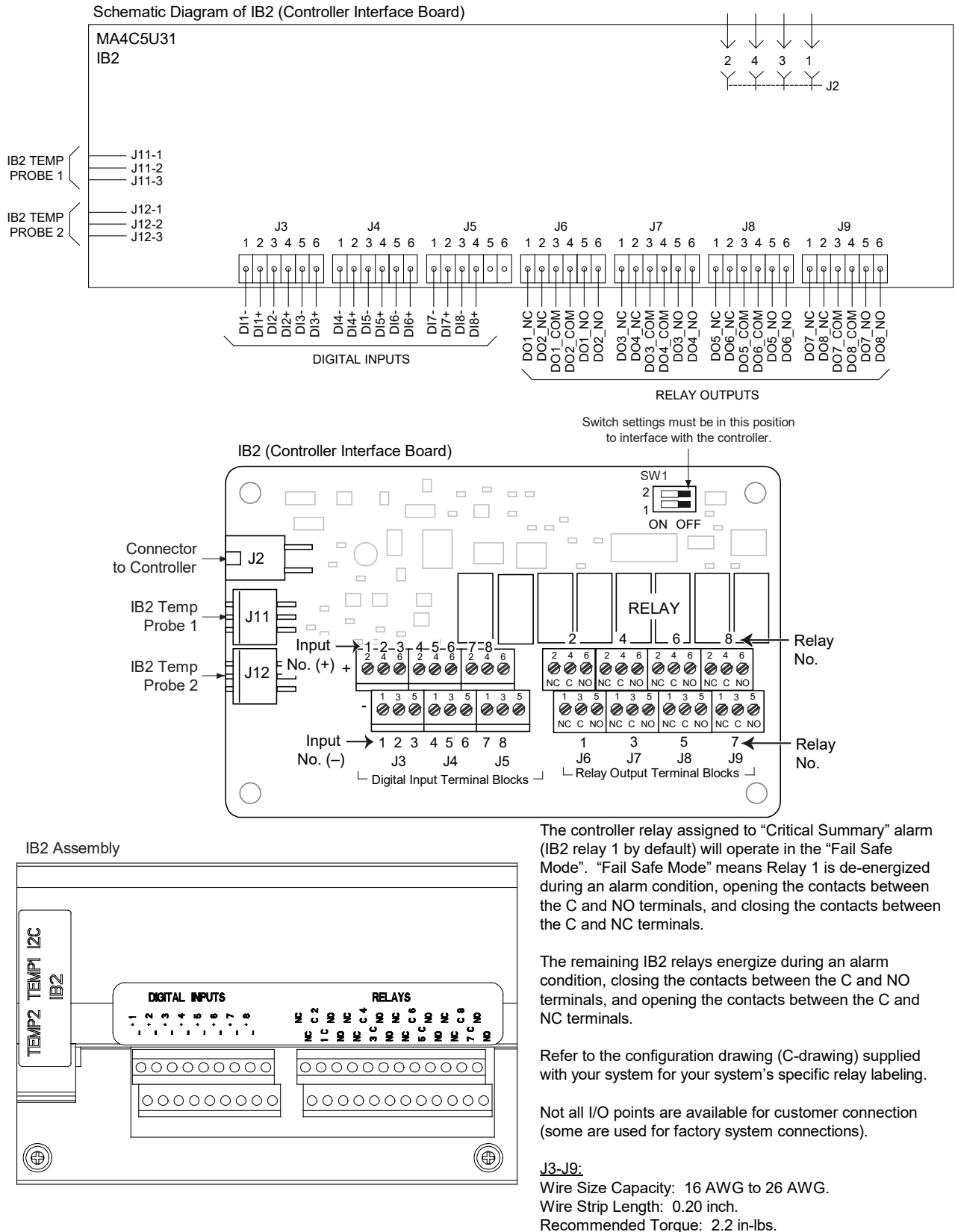
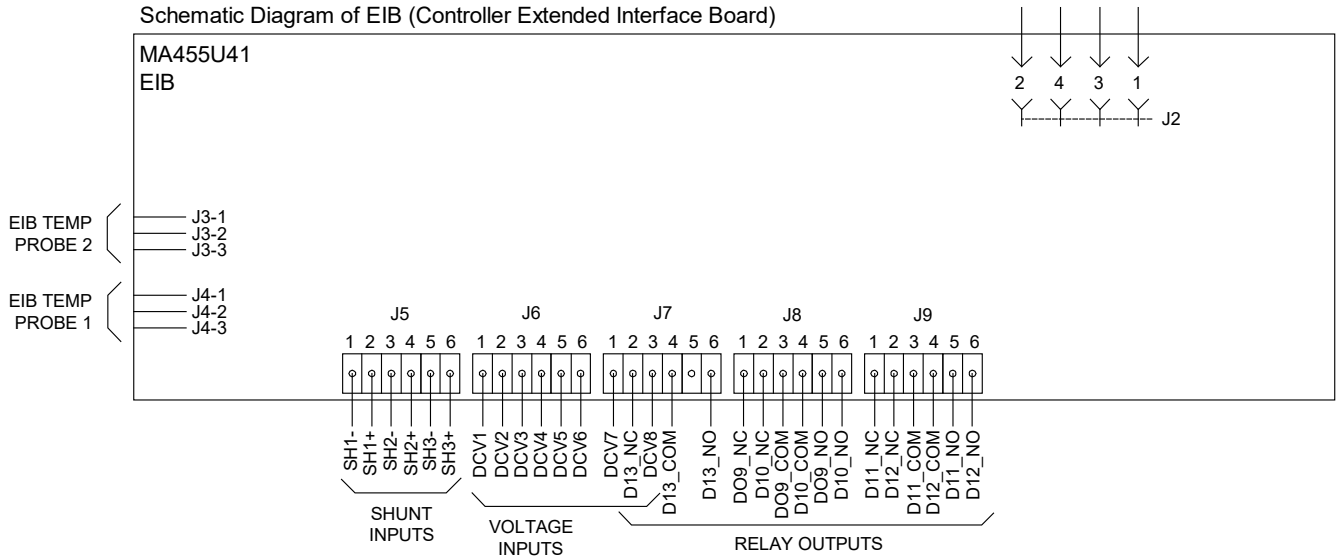

Figure 6
External Alarm, Reference, Monitoring, and Control Connections, IB2 (Controller Interface Board)

Vertiv™ NetSure™ 7100 Compact DC Power System

System Application Guide

Schematic Diagram of EIB (Controller Extended Interface Board)



EIB (Controller Extended Interface Board)

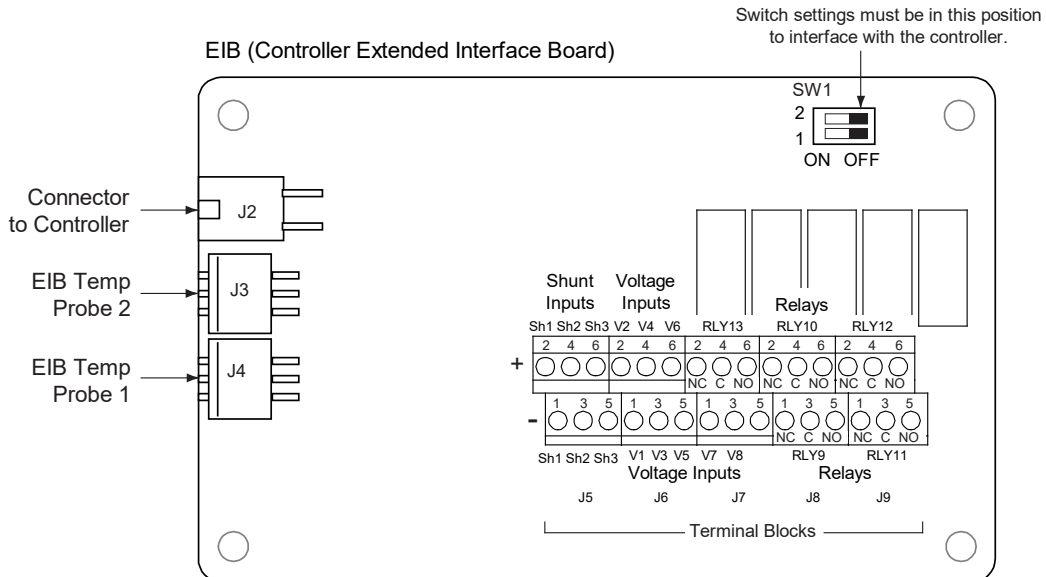

EIB Assembly

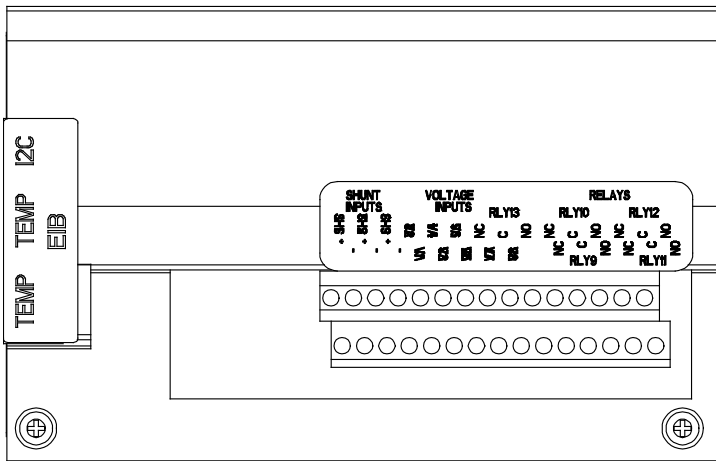

The EIB relays energize during an alarm condition, closing the contacts between the C and NO terminals, and opening the contacts between the C and NC terminals.

Refer to the configuration drawing (C-drawing) supplied with your system for your system's specific relay labeling.

Not all I/O points are available for customer connection (some are used for factory system connections).

J5-J9:

Wire Size Capacity: 16 AWG to 26 AWG.

Wire Strip Length: 0.20 inch.

Recommended Torque: 2.2 in-lbs.

Figure 7

External Alarm, Reference, Monitoring, and Control Connections, EIB (Controller Extended Interface Board)

NCU Controller Ethernet Connection (if required)

To NCU Front Panel

The NCU Controller provides a Web Interface via an Ethernet connection to a TCP/IP network. This interface can be accessed locally on a computer or remotely through a network. An RJ-45 Ethernet jack is provided on the front of the NCU.

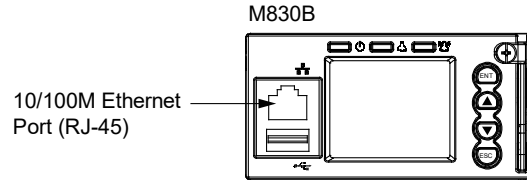

Figure 8
NCU Ethernet Port

Load Distribution Connections

General

Load leads are connected to the individual load busbars located on the distribution panels. Load return leads are connected to the return busbars located at the top of the system cabinet. These busbars provide M6 studs for installation of customer-provided two-hole lugs that have 6 mm bolt clearance holes on 5/8" centers.

Maximum size of wire to be connected to a single circuit breaker position is 2 AWG. Refer to Table 4 for available lugs. For wiring up to 350 kcmil, see "Special Application Crimp Lug / Strap Combination" in Table 6 (restrictions apply, see note in Table 6). Refer also to "Busbar Lug Adapter and Hardware Kits" in Table 7 for other lug options.

The rating of the distribution device determines the load lead wire size requirement. Table 10 can be used to select recommended load distribution wire sizes and lugs for various loop lengths per circuit breaker ampere rating.

582137100101, 582137100102

Refer to Figure 9.

582137100103, 582137100104

Refer to Figure 10.

582137100105, 582137100106

Refer to Figure 11.

Vertiv™ NetSure™ 7100 Compact DC Power System
System Application Guide

| Circuit Breaker Amperage | Recm 90°C Wire Size ⁽¹⁾ | | | | | | | |
|--------------------------------------|------------------------------------|----------------------------|----------------------------|-----------------------------|-----------------------------|-----------------------------|-----------------------------|---------|
| | 14 AWG | 12 AWG | 10 AWG | 8 AWG | 6 AWG | 4 AWG | 2 AWG | 1/0 AWG |
| | Loop Length (feet) ⁽²⁾ | | | | | | | |
| 1, 3, 5, 6, 10 A | 37 ^(3, 4, 5, 6) | 58 ^(3, 4, 5, 6) | 93 ^(3, 4, 5, 6) | 148 ^(3, 4, 5, 6) | 236 ^(3, 4, 5, 6) | 376 ^(3, 4, 5, 6) | 597 ^(3, 4, 5, 6) | -- |
| 15 A | 24 ^(3, 4, 5, 6) | 39 ^(3, 4, 5, 6) | 62 ^(3, 4, 5, 6) | 99 ^(3, 4, 5, 6) | 157 ^(3, 4, 5, 6) | 250 ^(3, 4, 5, 6) | 398 ^(3, 4, 5, 6) | -- |
| 20 A | -- | 29 ^(3, 4, 5, 6) | 46 ^(3, 4, 5, 6) | 74 ^(3, 4, 5, 6) | 118 ^(3, 4, 5, 6) | 188 ^(3, 4, 5, 6) | 298 ^(3, 4, 5, 6) | -- |
| 25 A | -- | -- | 37 ^(3, 4, 5, 6) | 59 ^(3, 4, 5, 6) | 94 ^(3, 4, 5, 6) | 150 ^(3, 4, 5, 6) | 239 ^(3, 4, 5, 6) | -- |
| 30 A | -- | -- | 31 ^(3, 4, 5, 6) | 49 ^(3, 4, 5, 6) | 78 ^(3, 4, 5, 6) | 125 ^(3, 4, 5, 6) | 199 ^(3, 4, 5, 6) | -- |
| 35 A | -- | -- | -- | 42 ^(3, 4, 5, 6) | 67 ^(3, 4, 5, 6) | 107 ^(3, 4, 5, 6) | 170 ^(3, 4, 5, 6) | -- |
| 40 A | -- | -- | -- | 37 ^(3, 4, 5, 6) | 59 ^(3, 4, 5, 6) | 94 ^(3, 4, 5, 6) | 149 ^(3, 4, 5, 6) | -- |
| 45 A | -- | -- | -- | 33 ^(3, 4, 5) | 52 ^(3, 4, 5, 6) | 83 ^(3, 4, 5, 6) | 132 ^(3, 4, 5, 6) | -- |
| 50 A | -- | -- | -- | 29 ^(3, 4) | 47 ^(3, 4, 5, 6) | 75 ^(3, 4, 5, 6) | 119 ^(3, 4, 5, 6) | -- |
| 60 A | -- | -- | -- | -- | 39 ^(3, 4, 5) | 62 ^(3, 4, 5, 6) | 99 ^(3, 4, 5, 6) | -- |
| 70 A | -- | -- | -- | -- | -- | 53 ^(3, 4, 5, 6) | 85 ^(3, 4, 5, 6) | -- |
| 75 A | -- | -- | -- | -- | -- | 50 ^(3, 4, 5) | 79 ^(3, 4, 5, 6) | -- |
| 80 A | -- | -- | -- | -- | -- | 47 ^(3, 4, 5) | 74 ^(3, 4, 5, 6) | -- |
| Recommended Crimp Lug ⁽⁷⁾ | | | | | | | | |
| Lug | 245342300 | 245342300 | 245342300 | 245390200 | 245346700 | 245346800 | 245346900 | -- |

| Circuit Breaker Amperage | Recm 90°C Wire Size ⁽¹⁾ | | | | | | | |
|--------------------------|------------------------------------|-----------------------------|-----------------------------|-----------------------------|--------------------------|-----------------------------|-----------------------|-------------|
| | 2 AWG | 1/0 AWG | 2/0 AWG | 3/0 AWG | 4/0 AWG | 250 kcmil | 350 kcmil | 500 kcmil |
| | Loop Length (feet) ⁽²⁾ | | | | | | | |
| 90 A | 66 ^(3, 4, 5, 6) | 105 ^(3, 4, 5, 6) | 133 ^(3, 4, 5, 6) | -- | -- | -- | -- | -- |
| 100 A | 59 ^(3, 4, 5) | 95 ^(3, 4, 5, 6) | 119 ^(3, 4, 5, 6) | -- | -- | -- | -- | -- |
| 125 A | 47 ⁽³⁾ | 76 ^(3, 4, 5, 6) | 95 ^(3, 4, 5, 6) | 120 ^(3, 4, 5, 6) | -- | -- | -- | -- |
| 150 A | -- | 63 ^(3, 4, 5) | 79 ^(3, 4, 5, 6) | 100 ^(3, 4, 5, 6) | -- | -- | -- | -- |
| 200 A | -- | -- | -- | 75 ^(3, 4) | 95 ^(3, 4, 5) | 112 ^(3, 4, 5, 6) | -- | -- |
| Recommended Crimp Lug | | | | | | | | |
| Lug | 245346900 ⁽⁷⁾ | 245393500 ⁽⁸⁾ | 245393600 ⁽⁸⁾ | 245393700 ⁽⁸⁾ | 245393800 ⁽⁸⁾ | 514872 ⁽⁸⁾ | 514873 ⁽⁸⁾ | See Note 9. |

Table 10 (cont'd on next page)
Recommended Battery and Load Distribution Wire Size and Lug Selection
for Bullet Nose-Type Circuit Breaker

Vertiv™ NetSure™ 7100 Compact DC Power System

System Application Guide

Notes to Table 10:

- ¹ Wire sizes based on recommendations of the American National Standards Institute (ANSI) approved National Fire Protection Association's (NFPA) National Electrical Code (NEC). Table 310.15 (B) (16) for copper wire at 90 °C conductor temperature. For operation in countries where the NEC is not recognized, follow applicable codes.
- ² Recommended wire sizes are sufficient to restrict voltage drop to 1.0 volt or less at listed branch current for the loop lengths shown. Loop length is the sum of the lengths of the positive and negative leads.
- ³ Wire Size / Loop Length Combination Calculated using 40 °C Ambient Operating Temperature.
- ⁴ Wire Size / Loop Length Combination Calculated using 50 °C Ambient Operating Temperature.
- ⁵ Wire Size / Loop Length Combination Calculated using 55 °C Ambient Operating Temperature.
- ⁶ Wire Size / Loop Length Combination Calculated using 65 °C Ambient Operating Temperature.
- ⁷ These lugs are two-hole for 1/4" bolt clearance on 5/8" centers. Lugs should be crimped per lug manufacturer's specifications.
- ⁸ Special application crimp lug / strap combination (restrictions apply, see note in Table 6).
- ⁹ See "Special Application Crimp Lug / Strap Combination, Busbar Lug Adapters, and Hardware Kits" on page 21 and Table 5.

Table 10 (cont'd from previous page)
Recommended Battery and Load Distribution Wire Size and Lug Selection
for Bullet Nose-Type Circuit Breaker

Vertiv™ NetSure™ 7100 Compact DC Power System
System Application Guide

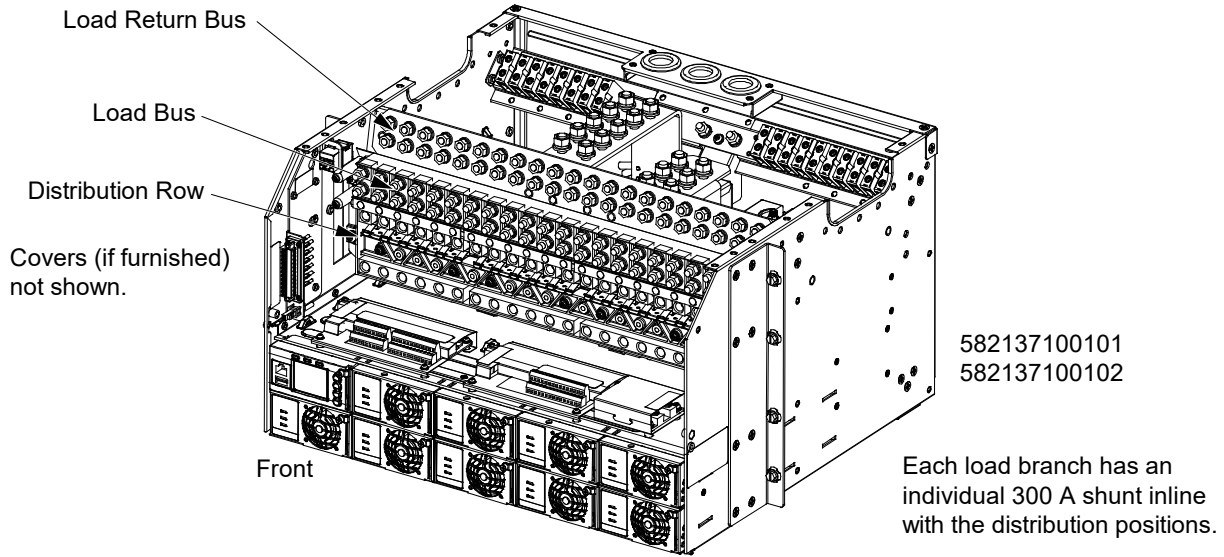

Battery disconnects with LVBD.

DO NOT install multi-pole devices across load branches.

M6 Studs on 5/8" Centers

Maximum Lug Width:
0.625 inches.

Busbar Hardware:
M6 Hex Nut
M6 Lock Washer
M6 Flat Washer

Recommended Torque:
45 in-lbs.

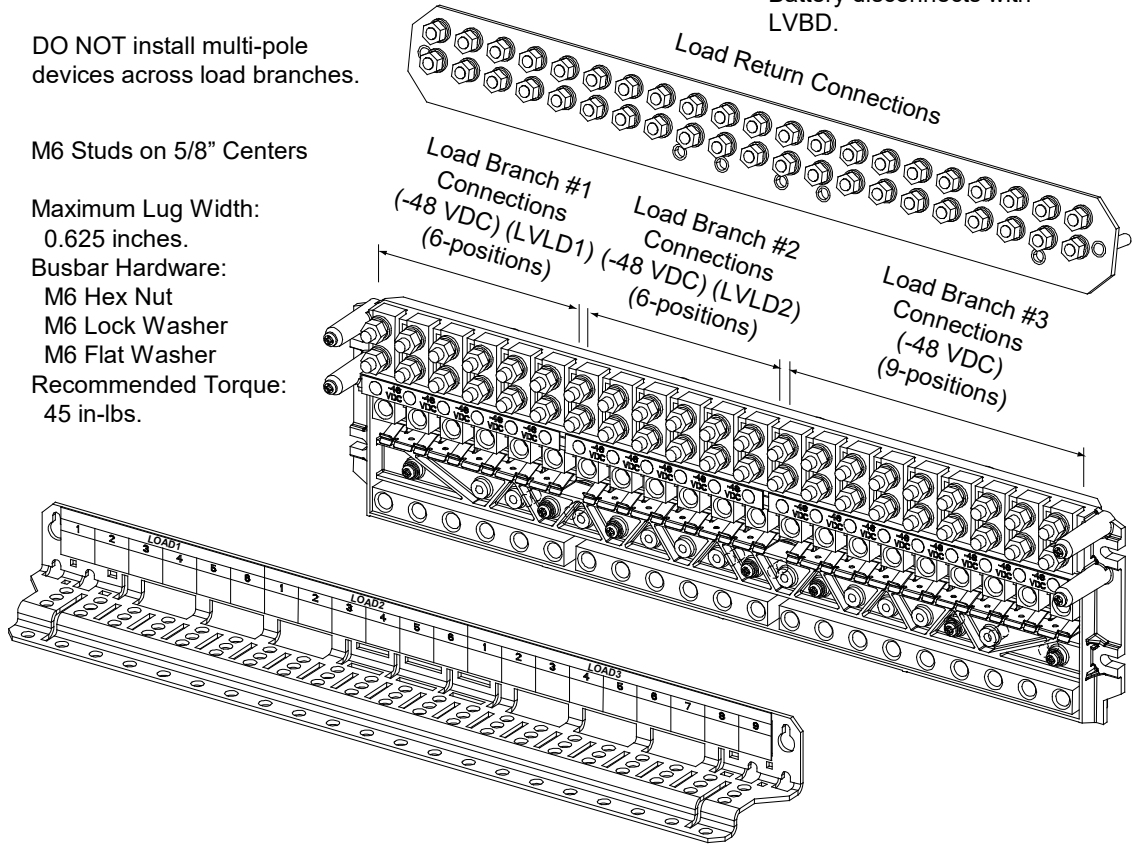
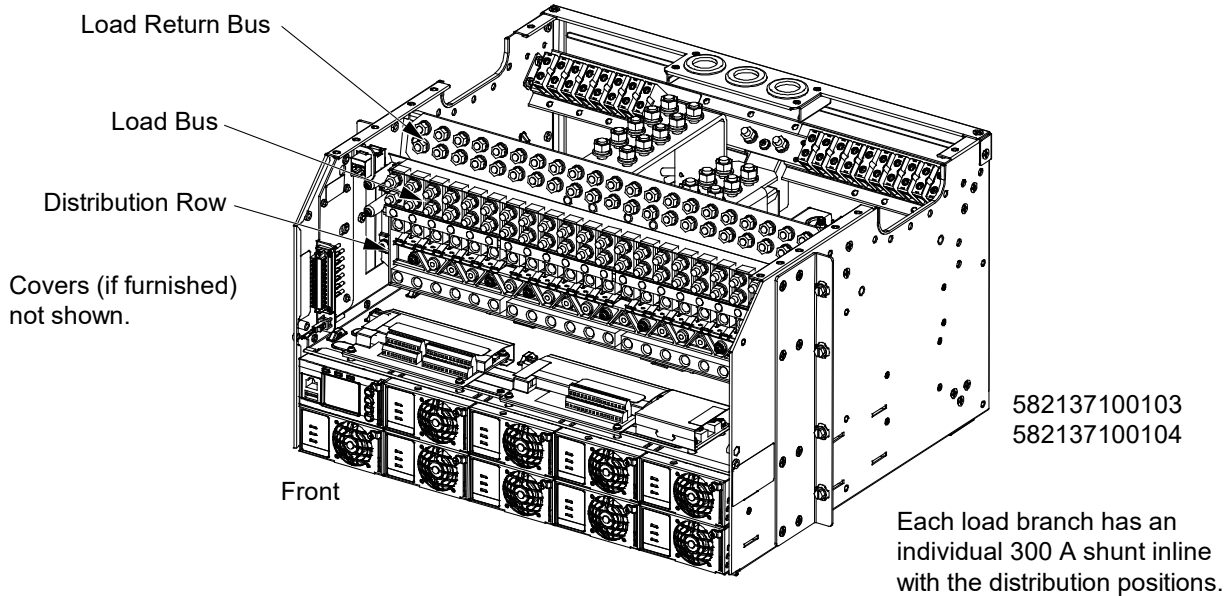

Figure 9
582137100101, 2582137100102 Load Connections

Vertiv™ NetSure™ 7100 Compact DC Power System
System Application Guide



DO NOT install multi-pole devices across load branches.

No LVBD.

M6 Studs on 5/8" Centers

Maximum Lug Width:
0.625 inches.

Busbar Hardware:
M6 Hex Nut
M6 Lock Washer
M6 Flat Washer

Recommended Torque:
45 in-lbs.

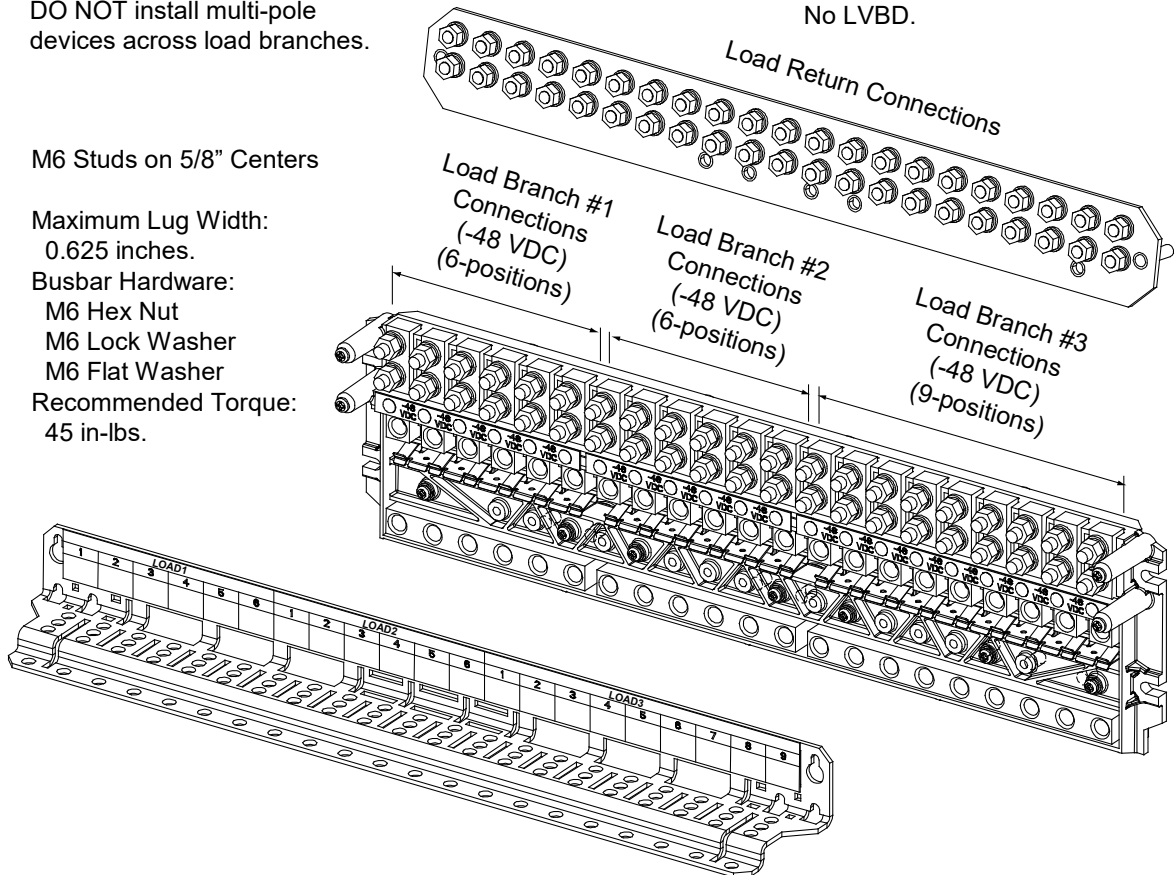
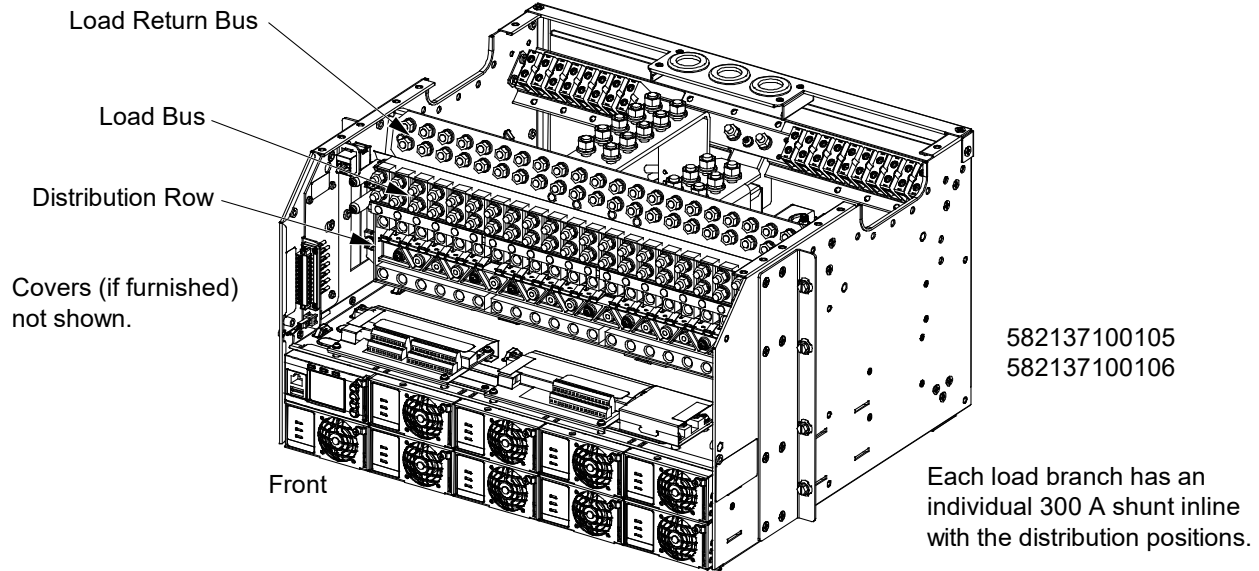

Figure 10
582137100103, 2582137100104 Load Connections

Vertiv™ NetSure™ 7100 Compact DC Power System
System Application Guide



DO NOT install multi-pole devices across load branches.

M6 Studs on 5/8" Centers

Maximum Lug Width:
0.625 inches.

Busbar Hardware:
M6 Hex Nut
M6 Lock Washer
M6 Flat Washer

Recommended Torque:
45 in-lbs.

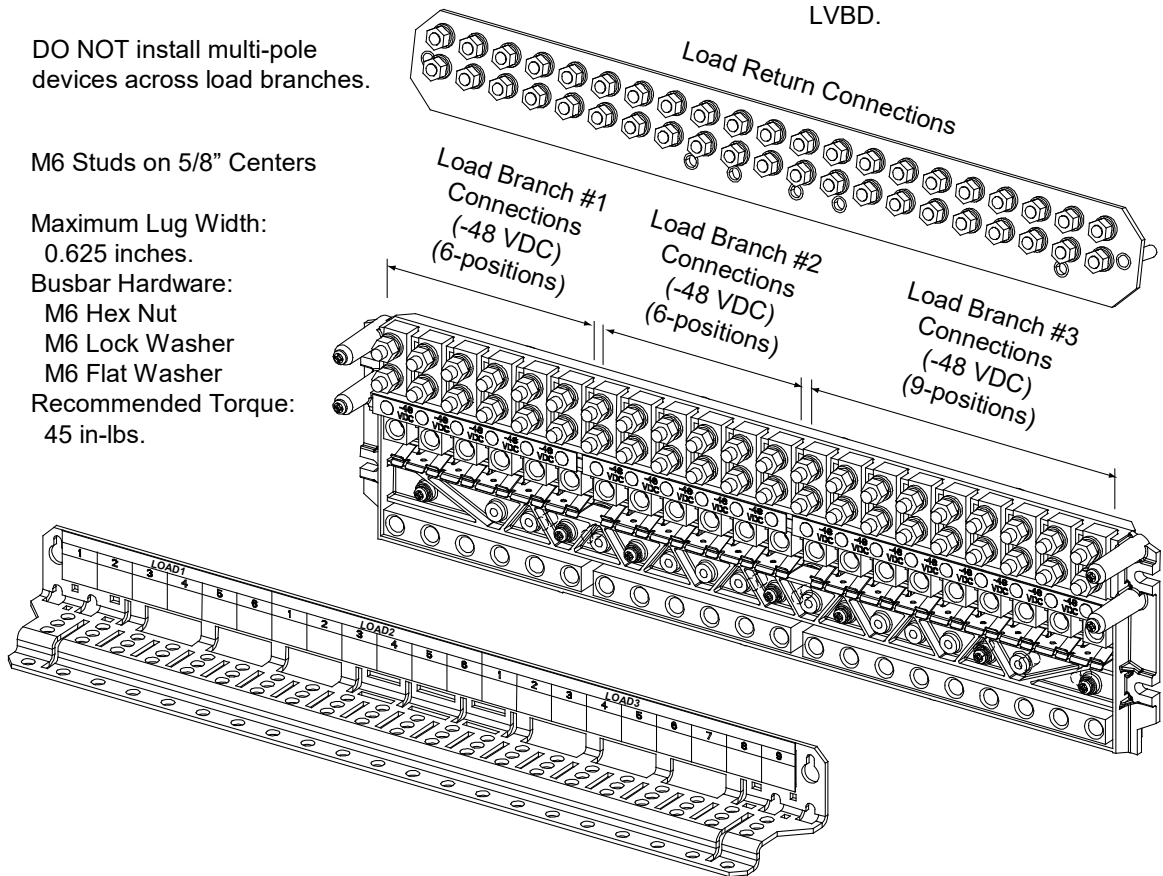

Figure 11
582137100105, 2582137100106 Load Connections

Vertiv™ NetSure™ 7100 Compact DC Power System

System Application Guide

Input Battery Connections

General

Input battery leads are connected to the battery (load side) busbar and battery return busbar. These busbars provide M8 studs for installation of customer provided two hole lugs that have 8 mm bolt clearance holes on 1 inch centers.

Battery wire size and lug requirements are determined by site requirements. See Table 5 for available lugs.

Refer to Figure 12.

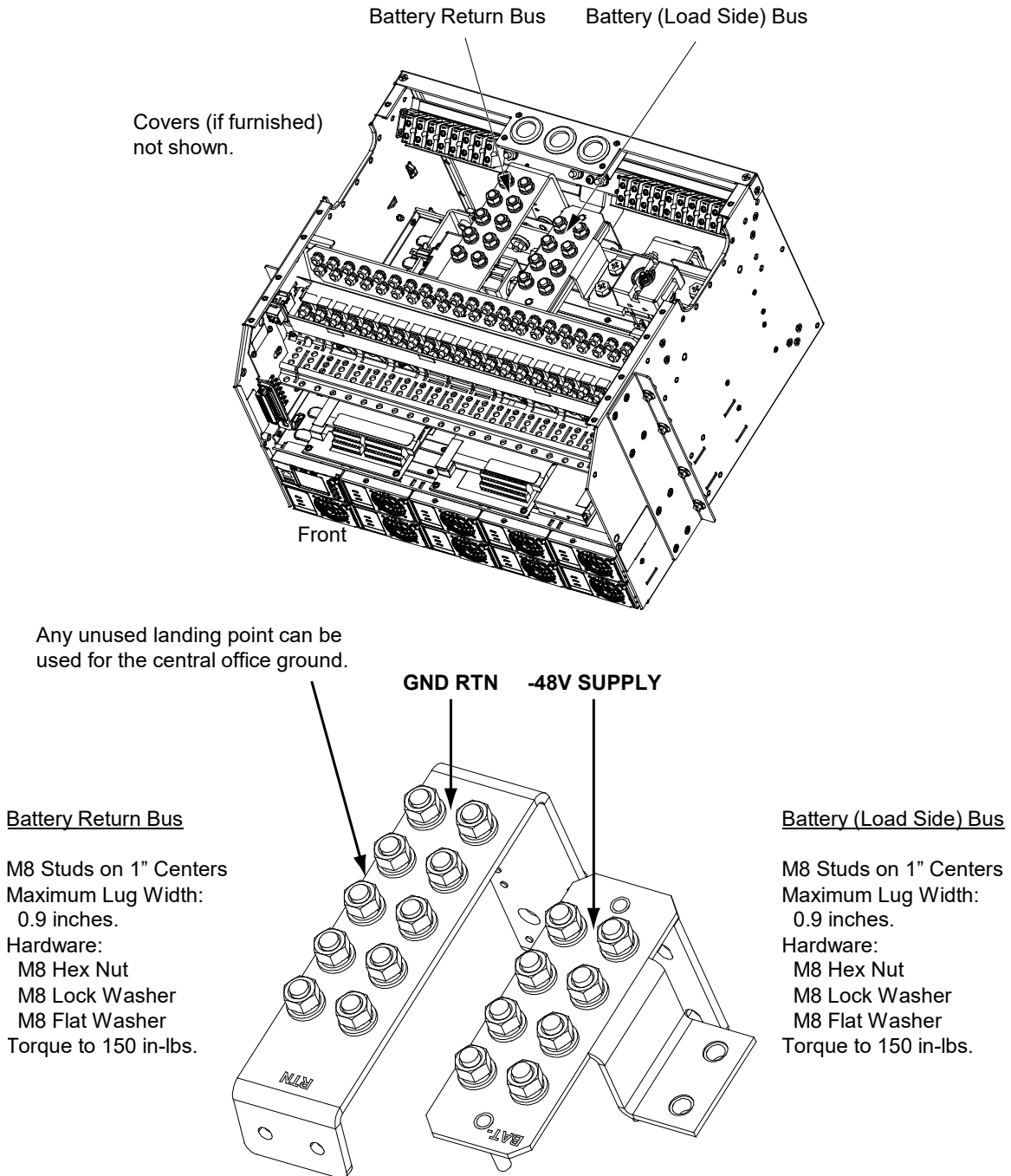

Figure 12
Battery Connections

SPECIFICATIONS

1. SYSTEM

1.1 DC Output Ratings

1.1.1 See page 2.

1.1.2 The product has a short circuit rating of 10,000 DC amperes.

1.2 AC Input Ratings

1.2.1 See page 2.

1.3 Environmental Ratings

1.3.1 Operating Ambient Temperature Range:

(A) Without Front Door, Top Covers, and Rear Covers: -40 °C to +65 °C (-40 °F to +149 °F).

(B) With Front Door, Top Covers, and Rear Covers: -40 °C to +40 °C (-40 °F to +104 °F).

1.3.2 Storage Ambient Temperature Range: -40 °C to +70 °C (-40 °F to +158 °F).

1.3.3 Relative Humidity: Capable of operating in an ambient relative humidity range of 0% to 95%, non-condensing.

1.3.4 Altitude: Capable of operating in an altitude range of -200 feet to 10,000 feet. The maximum operating ambient temperature should be de-rated by 3 °C per 1000 feet above 6562 feet.

1.3.5 EMI/RFI Suppression: This equipment has been tested and found to comply with the limits for a Class B digital device, pursuant to Part 15, Subpart B of the FCC Rules. These limits are designed to provide reasonable protection against harmful interference when the equipment is operated in a residential environment. This equipment generates, uses and can radiate radio frequency energy and, if not installed and used in accordance with the instruction manual, may cause harmful interference to radio communications. However, there is no guarantee that interference will not occur in a particular installation. If this equipment does cause harmful interference to radio or television reception, which can be determined by turning the equipment off and on, the user is encouraged to try and correct the interference by one or more of the following measures.

(A) Reorient or relocate the receiving antenna.

(B) Increase the separation between the equipment and receiver.

(C) Connect the equipment into an outlet on a circuit different from that to which the receiver is connected.

1.3.6 Mounting: This power system is designed to mount in a standard 19" or 23" relay rack or equipment rack having 1" or 1-3/4" multiple drillings. Wall mounting options are also available. Refer to "Overall Dimensions" on page 40 for mounting dimensions.

- This product is intended only for installation in a restricted access location on or above a non-combustible surface.
- This product must be located in a controlled environment with access to crafts persons only.
- This product is intended for installation in network telecommunication facilities (CO, vault, hut, or other environmentally controlled electronic equipment enclosure).
- This product is intended to be connected to the common bonding network in a network telecommunication facility (CO, vault, hut, or other environmentally controlled electronic equipment enclosure).
- The DC return connection to this system can remain isolated from system frame and chassis (DC-I).
- This system is suitable for installation as part of the Common Bonding Network (CBN).
- The system must be mounted in an environment that does not exceed the Operating Ambient Temperature Range stated above.
- Clearance requirements are (relay rack):
 - a) Recommended minimum aisle space clearance for the front of each bay is 2'6".
 - b) Recommended minimum aisle space clearance for the rear of each bay is 2'0".
- Clearance requirements are (cabinet or wall mounting):
 - a) Recommended minimum clearance for the rear of the system is 4".

Vertiv™ NetSure™ 7100 Compact DC Power System

System Application Guide

1.4 Compliance Information

1.4.1 Safety Compliance: UL 62368-1 Recognized (“cURus”). This is a UL Recognized power system for use in Information and Communication Technology Equipment.

1.4.2 NEBS Compliance: Compliance verified by a Nationally Recognized Testing Laboratory (NRTL) per GR-1089-CORE and GR-63-CORE. Contact Vertiv for NEBS compliance reports.

Rectifier Modules: In order to remain compliant during a fan failure condition, the backup battery connection must be utilized to provide sufficient power to the loads for up to eight (8) hours when the system is operated at greater than 50% output power. If no backup battery connection is used, the system must operate with a redundant module installed.

1.4.3 GR-3108: GR-3108 class 2 compliant.

1.5 IB2 and EIB (Controller Interface Board) Ratings

1.5.1 Digital Input Ratings

(A) Maximum Voltage Rating: 60 VDC.

(B) Active High: > 19 VDC.

(C) Active Low: < 1 VDC.

1.5.2 Relay Ratings

(A) Steady State: 0.5 A @ 60 VDC, 1.0 A @ 30 VDC.

(B) Peak: 3 A @ 30 VDC.

2. RECTIFIER

Refer to the Rectifier Instructions (UM1R483500E3).

3. CONTROLLER

Refer to the NCU Controller Instructions (UM1M830BNA).

For controller factory settings, refer to the Controller Configuration Drawing (C-drawing).

MECHANICAL SPECIFICATIONS

Overall Dimensions

582137100101, 582137100103, 582137100105 Configured System

Notes:

1. All dimensions are in inches unless otherwise specified.
2. Finish: Galvanized steel.

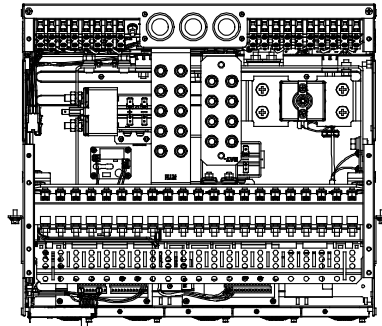

Top View

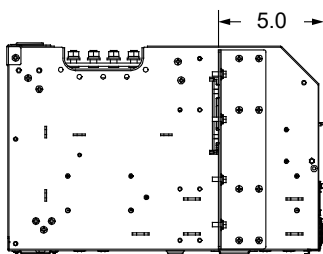

Left Side View

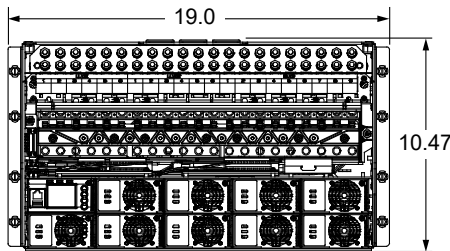

Front View

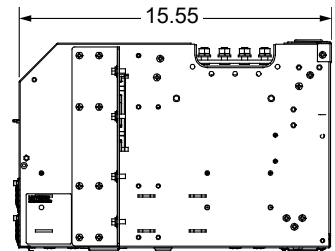

Right Side View

See Mounting Angle Detail

Mounting Angle Detail

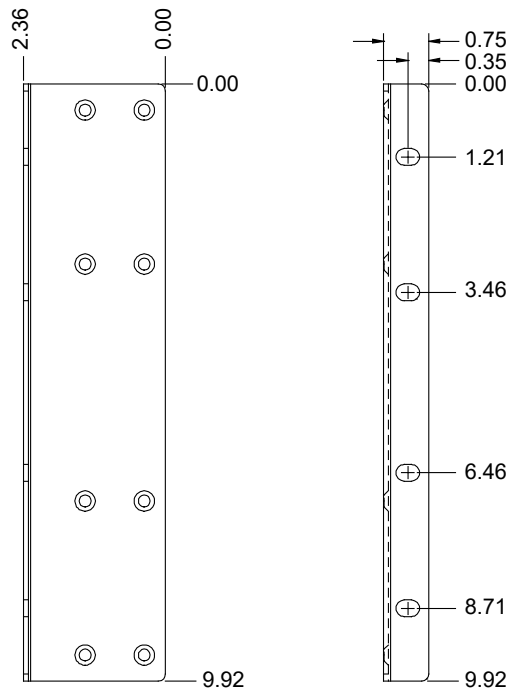

Vertiv™ NetSure™ 7100 Compact DC Power System

System Application Guide

582137100102, 582137100104, 582137100106 Configured System

Notes:

1. All dimensions are in inches unless otherwise specified.
2. Finish: Front door textured dark gray, all other galvanized steel.

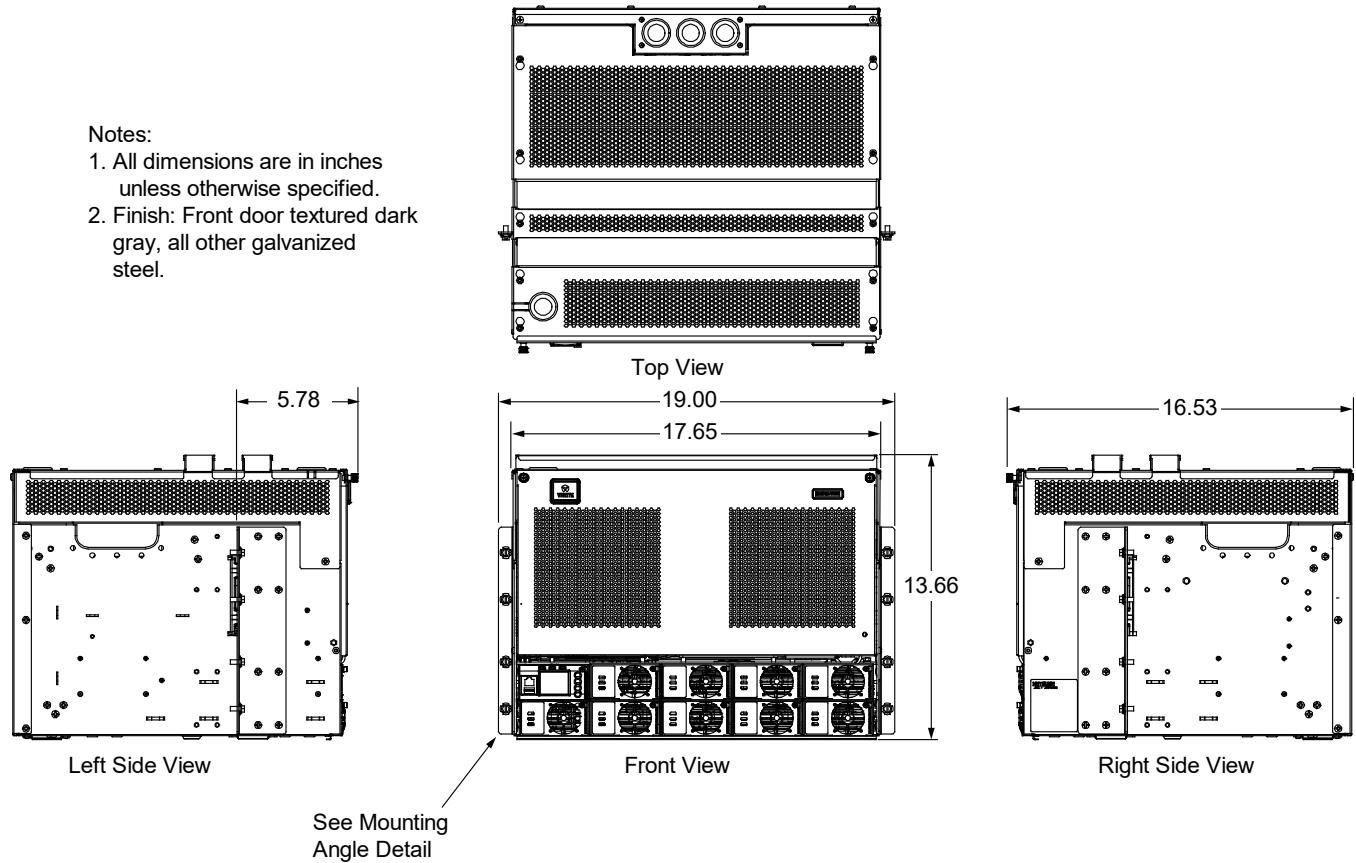

Mounting Angle Detail

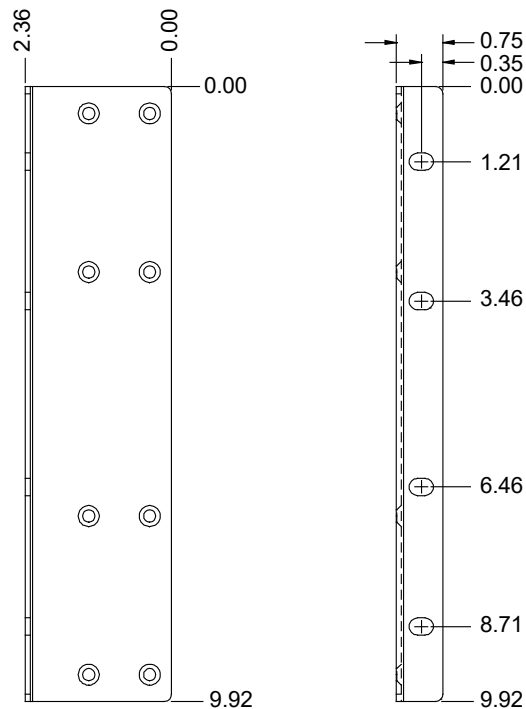

Vertiv™ NetSure™ 7100 Compact DC Power System System Application Guide

System with Optional Wall Mount Bracket Kit, P/N 565533

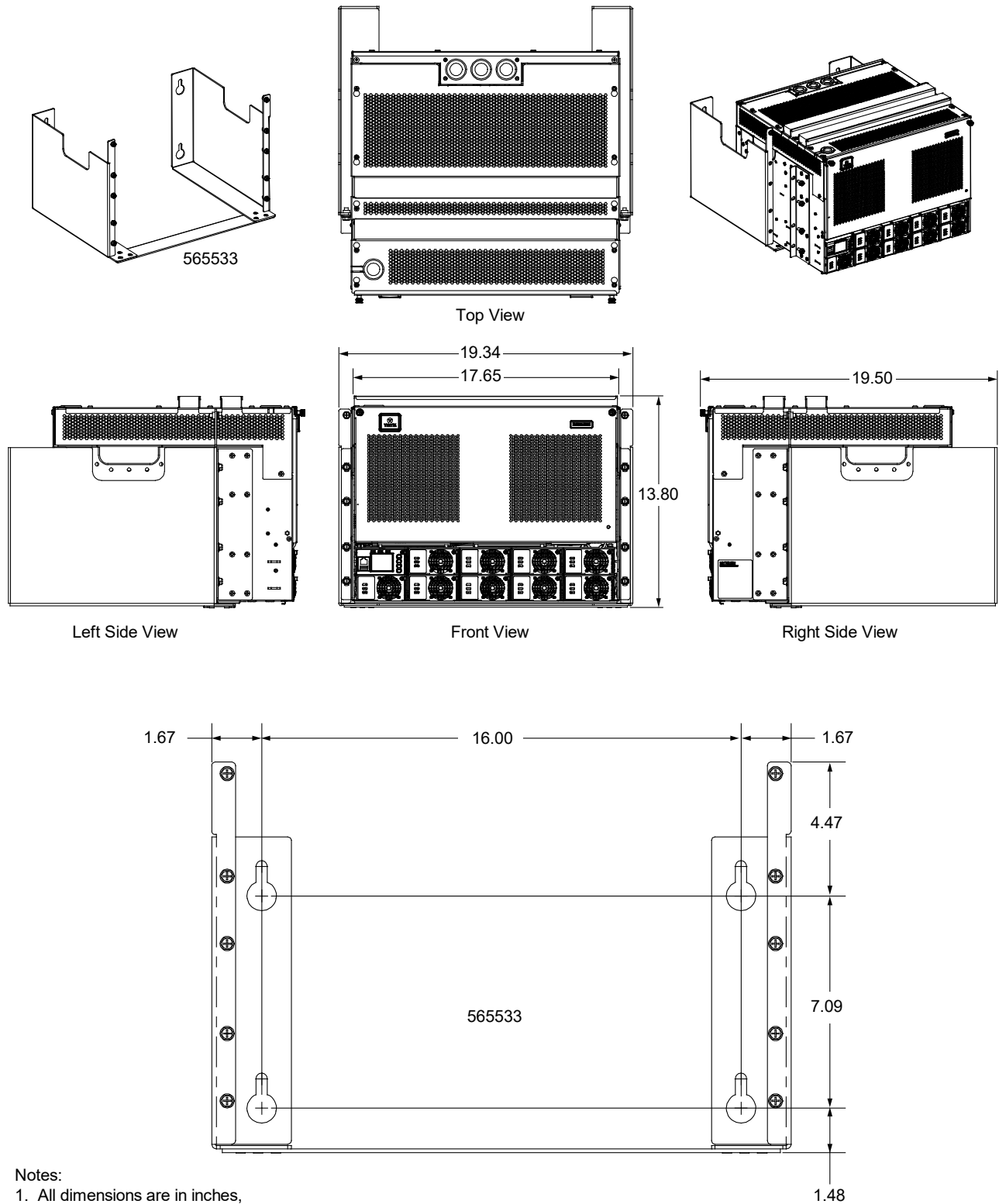

Notes:

1. All dimensions are in inches, unless otherwise specified.
2. Installer to furnish hardware for fastening bracket to wall.

Vertiv™ NetSure™ 7100 Compact DC Power System

System Application Guide

Weights

| List Number or Part Number | Net Weight (lbs), each | Description |
|----------------------------------|---------------------------|-------------------|
| Configured System | | |
| 582137100101 | 49 | Configured System |
| 582137100102 | 54 | Configured System |
| 582137100103 | 42 | Configured System |
| 582137100104 | 47 | Configured System |
| 582137100105 | 46 | Configured System |
| 582137100106 | 51 | Configured System |
| Rectifier | | |
| 1R483500e3 | 3.7 | Rectifier Module |
| Controller | | |
| 1M830BNA | 2.2 | NCU Controller |
| Relay Racks | | |
| 559817 | 51 | Relay Rack |
| 559819 | 156 | Relay Rack |
| 562353 | 229 | Relay Rack |
| 559818 | 103 | Relay Rack |
| 559820 | 113 | Relay Rack |
| 559821 | 81 | Relay Rack |
| 559822 | 123 | Relay Rack |
| 559824 | 93 | Relay Rack |
| 559823 | 167 | Relay Rack |

RELATED DOCUMENTATION

| | |
|---|-------------------------|
| System Installation and User Instructions: | UM582137100101 |
| NCU Controller Instructions: | UM1M830BNA |
| Rectifier Instructions: | UM1R483500E3 |
| Main Schematic Diagrams: | SD582137100101 (System) |
| Main Wiring Diagrams: | T582137100101 (System) |

Vertiv.com | Vertiv Headquarters, 505 N Cleveland Ave, Westerville, OH 43082, USA

© 2023 Vertiv Group Corp. All rights reserved. Vertiv™ and the Vertiv logo are trademarks or registered trademarks of Vertiv Group Corp. All other names and logos referred to are trade names, trademarks or registered trademarks of their respective owners. While every precaution has been taken to ensure accuracy and completeness here, Vertiv Group Corp. assumes no responsibility, and disclaims all liability, for damages resulting from use of this information or for any errors or omissions.

