



# NetSure™ Mini Control Unit Controller

## User Manual

Specification Number: 1M831ANA

Model Number: M831A

Software Version 6.2.40

The information contained in this document is subject to change without notice and may not be suitable for all applications. While every precaution has been taken to ensure the accuracy and completeness of this document, Vertiv assumes no responsibility and disclaims all liability for damages resulting from use of this information or for any errors or omissions. Refer to other local practices or building codes as applicable for the correct methods, tools, and materials to be used in performing procedures not specifically described in this document.

The products covered by this instruction manual are manufactured and/or sold by Vertiv. This document is the property of Vertiv and contains confidential and proprietary information owned by Vertiv. Any copying, use or disclosure of it without the written permission of Vertiv is strictly prohibited.

Names of companies and products are trademarks or registered trademarks of the respective companies. Any questions regarding usage of trademark names should be directed to the original manufacturer.

## Technical Support Site

If you encounter any installation or operational issues with your product, check the pertinent section of this manual to see if the issue can be resolved by following outlined procedures.

Visit <https://www.vertiv.com/en-us/support/> for additional assistance.

Visit <https://www.vertiv.com/en-emea/support/> for additional assistance.

Visit <https://www.vertiv.com/zh-CN/support/> for additional assistance.

## TABLE OF CONTENTS

<b>Admonishments Used in this Document.....</b>	<b>viii</b>
<b>Important Safety Instructions.....</b>	<b>ix</b>
<b>Static Warning .....</b>	<b>x</b>
<b>1 Introduction.....</b>	<b>1</b>
1.1 Preface .....	1
1.2 Overview.....	1
1.3 Function Descriptions.....	2
1.3.1 Rectifier, Solar Converter, Converter, Inverter Control.....	2
1.3.2 System Components Monitoring and System Alarms Generation .....	3
1.3.3 Operating Data Acquisition and Data Logs.....	3
1.3.4 Battery Management .....	4
1.3.5 Energy Management.....	8
1.3.6 Power Split Feature .....	9
1.3.7 AC Generator Function.....	9
1.3.8 Diesel Management Feature.....	10
1.3.9 Hybrid Control Function (Supporting Generator, Solar and Wind Energy Input, and Optimization).....	10
1.3.10 Supervisory Module (SM Modules) Monitoring .....	14
1.3.11 Maximum Current Limit Function.....	14
1.3.12 Communications Function.....	14
1.3.13 FIAMM SoNick (Sodium Nickel) Battery Interface.....	15
1.3.14 Radius Server Feature.....	16
<b>2 Operation .....</b>	<b>17</b>
2.1 Controller Initialization .....	17
2.2 Controller's Front Panel Indicators .....	18
2.3 Controller's Front Panel Menu Navigation Keys and Local Display.....	18
2.4 Passwords and Privilege Levels.....	19
2.5 Multiple Languages Supported .....	19
2.6 Using the Local Keypad and Display.....	19
2.6.1 Local Menu Navigation Keys and Local Display .....	20
2.6.2 Local Display Menus .....	20
2.6.3 Navigating the Local Display Menus.....	20
2.7 Using the Web Interface.....	20
2.7.1 Overview .....	20
2.7.2 Supported Browsers .....	20
2.7.3 Web Interface Screens .....	20
2.7.4 Logging into the Controller via Web Interface Access .....	21
2.8 Setup Procedures.....	22
2.8.1 Setting IPv4 Communications Parameters (if controller not set as DHCP).....	22
2.8.2 Setting IPv6 Communications Parameters (if controller not set as DHCPv6) .....	22
2.8.3 Setting for DHCP and DHCPv6 .....	22
2.8.4 Connecting the Controller to your Local Area Network (LAN) when the System is NOT Equipped with an IB4 Board.....	23

2.8.5	Connecting the Controller to your Local Area Network (LAN) when the System IS Equipped with an IB4 Board.....	23
2.8.6	Connecting a Local Computer Directly to the Controller when the System is NOT Equipped with an IB4 Board.....	23
2.8.7	Connecting a Local Computer Directly to the Controller when the System IS Equipped with an IB4 Board.....	25
2.9	Common Tasks Performed via the Local Keypad and/or Web Interface.....	25
2.9.1	General.....	25
2.9.2	Reset Admin Password Feature.....	25
2.9.3	Viewing Alarms.....	25
2.9.4	Viewing System Status.....	26
2.9.5	Viewing the Controller’s Device Inventory.....	26
2.9.6	Clearing or Resetting Alarms.....	26
2.9.7	Clearing Logs.....	26
2.9.8	Changing the Local LCD Display Orientation.....	26
2.9.9	Disabling the Local Keypad Sound.....	26
2.9.10	Blocking Alarms.....	27
2.9.11	Changing the Date and Time.....	27
2.9.12	Adding, Deleting, and Modifying Users.....	27
2.9.13	Setting IP Communications Parameters (if controller not set as DHCP or DHCPv6).....	27
2.9.14	Setting for DHCP and DHCPv6.....	28
2.9.15	Setting SNMP Parameters.....	28
2.9.16	Setting TL1 Parameters.....	28
2.9.17	Setting Auto Equalize.....	29
2.9.18	Programming the Audible Alarm Feature.....	29
2.9.19	Manually Forcing LVDs.....	29
2.9.20	Manually Forcing Relays.....	29
2.9.21	Assigning Severity Level to Alarms.....	30
2.9.22	Assigning Relays to Alarms.....	30
2.9.23	Placing the System in Float or Equalize Charge Mode.....	30
2.9.24	Viewing/Changing the Float Voltage Setting.....	30
2.9.25	Viewing/Changing the Equalize Voltage Setting.....	30
2.9.26	Setting Battery Parameters.....	31
2.9.27	Setting Battery Capacity Parameters.....	31
2.9.28	Setting Rectifier High Voltage Shutdown.....	31
2.9.29	Setting Solar Converter High Voltage Shutdown.....	31
2.9.30	Setting Rectifier Current Limit.....	31
2.9.31	Checking the Controller’s Current Limit Point after Adding or Removing a Rectifier or Converter Module.....	31
2.9.32	Enabling Solar Mode.....	32
2.9.33	Setting Over Voltage Alarm 1.....	32
2.9.34	Setting Over Voltage Alarm 2.....	32
2.9.35	Setting Under Voltage Alarm 1.....	33
2.9.36	Setting Under Voltage Alarm 2.....	33
2.9.37	Setting Temperature Sensors.....	33



2.9.38	Setting Battery Charge Temperature Compensation .....	34
2.9.39	Setting Battery Thermal Runaway Management (BTRM) Feature .....	34
2.9.40	Configuring the Controller Identification of Rectifiers and Assigning which Input Feed is Connected to the Rectifiers .....	35
2.9.41	Configuring the Controller Identification of Solar Converters .....	35
2.9.42	Configuring the Controller Identification of Converters .....	36
2.9.43	Setting Digital Inputs .....	36
2.9.44	Setting Battery Block and Battery Midpoint Monitoring (if equipped with an EIB Assembly) .....	36
2.9.45	Setting External Shunts (connected to the EIB Assembly) .....	36
2.9.46	Setting External Shunts (connected to the SMDU+ Assembly) .....	37
2.9.47	Setting Shunts (connected to the SMDU Assembly) .....	38
2.9.48	Setting the SM-DUE Parameters (if furnished) .....	38
2.9.49	Setting the System Current Alarm .....	40
2.9.50	Setting the AC Generator Function .....	40
2.9.51	Using the Relay Test Feature .....	40
2.9.52	Clearing the Maintenance Alarm .....	41
2.9.53	Performing a Manual Battery Discharge Test .....	42
2.9.54	Updating the Controller's Device Inventory .....	42
2.9.55	Backing Up the Controller Configuration .....	42
2.9.56	Reloading a Backed-Up Controller Configuration .....	43
2.9.57	Upgrading the Controller Using an Application ("All") Package .....	43
2.9.58	Restoring Factory Default Configuration .....	43
2.9.59	Rebooting the Controller .....	44
2.9.60	Changing the Names of Items Displayed in the LCD and Web-Interface Menus .....	44
2.9.61	Upgrading the Rectifiers Firmware .....	45
2.9.62	Upgrading the Inverters Firmware .....	45
2.10	Power Split Feature .....	46
2.10.1	Overview .....	46
2.11	FIAMM SoNick (Sodium Nickel) Batteries Interface .....	52
2.11.1	FIAMM Battery Installation and User Instructions .....	52
2.12	TL1 Interface .....	54
2.12.1	General .....	54
2.12.2	Controller TL1 Feature .....	55
2.13	Machine-to-Machine HTTP Interface .....	55
2.13.1	Description .....	55
2.13.2	Using the Machine-to-Machine HTTP Interface Option .....	55
2.13.3	EXAMPLE .....	58
2.14	Resolving Alarms .....	58
<b>3</b>	<b>Local Display Menus .....</b>	<b>80</b>
3.1	Overview .....	80
3.2	Factory Default Setpoints .....	80
3.3	Adjustment Range Restrictions .....	80
3.4	Main Screen .....	81
3.5	Information Screens (accessed from the MAIN SCREEN) .....	81

3.6	Main Menu.....	83
3.7	Local Display Menus.....	83
<b>4</b>	<b>Description of Local Display Menu Programmable Parameters.....</b>	<b>95</b>
4.1	Settings Menu.....	95
4.1.1	Maintenance Sub-Menu.....	95
4.1.2	Energy Saving Sub-Menu.....	95
4.1.3	Alarm Setting Sub-Menu.....	96
4.1.4	Rect Settings Sub-Menu.....	96
4.1.5	Batt Settings Sub-Menu.....	96
4.1.6	Batt1 Setting Sub-Menu.....	98
4.1.7	Batt2 Setting Sub-Menu.....	98
4.1.8	LVD Settings Sub-Menu.....	98
4.1.9	AC Settings Sub-Menu.....	99
4.1.10	Other Setting Sub-Menu.....	99
4.1.11	Communication Sub-Menu.....	99
4.1.12	Sys Settings Sub-Menu.....	99
<b>5</b>	<b>Web Interface Screens.....</b>	<b>101</b>
5.1	Overview of Web Function.....	101
5.2	Homepage.....	101
5.3	System Status Information Area.....	102
5.4	System Specifications Information Area.....	102
5.5	Controller Specifications Information Area.....	102
5.6	Site Information Area.....	102
5.7	Alarms Area.....	103
5.8	System Status Area.....	104
5.8.1	Power System Tab.....	104
5.8.2	Energy Sources Status Tab.....	129
5.8.3	General Status Tab.....	130
5.8.4	Custom Input Status Tab.....	131
5.9	Menu Navigation Area.....	132
5.9.1	Settings Menu.....	133
5.9.2	History Log Menu.....	154
5.9.3	System Inventory Menu.....	164
5.9.4	Advanced Settings Menu.....	165
<b>6</b>	<b>Accessing the Controller via a Network Management System (NMS).....</b>	<b>223</b>
6.1	General.....	223
6.2	NMS Supported by SNMP Agent.....	223
6.2.1	NMS Supported by SNMP v2.....	223
6.2.2	NMS Supported by SNMP v3.....	223
6.2.3	Parameter Setting in SNMP Manager.....	224
6.3	MIB Installation.....	225
6.3.1	Installation.....	225
6.3.2	Contents of the Controller's MIB.....	225
6.4	Accessing the Controller through an NMS.....	225

6.4.1	Apply Administrative Privilege.....	225
6.5	ESR Configure.....	225
<b>7</b>	<b>Accessing the Controller via TL1.....</b>	<b>232</b>
7.1	Accessing the TL1 Port.....	232
7.1.1	Port Connection.....	232
7.1.2	TL1 Port Connection Keep-Alive Feature.....	232
7.2	TL1 User Session.....	232
7.2.1	Establishing a Session.....	232
7.2.2	TL1 Autonomous Messages.....	232
7.3	TL1 Port Configuration.....	233
7.4	TL1 Commands, Autonomous Messages, and Error Codes Supported by the Controller.....	233
7.4.1	Format Overview of Required TL1 Messages.....	233
7.4.2	Samples.....	235
7.4.3	Table of TL1 Commands Supported.....	237
7.4.4	Expanded Description of TL1 Commands Supported (in alphabetical order).....	238
7.4.5	TL1 Autonomous Messages Supported (in alphabetical order).....	246
7.4.6	List of Error Codes for TL1 Commands Supported (in alphabetical order).....	250
<b>8</b>	<b>Inverter Only System.....</b>	<b>251</b>
8.1	General.....	251
8.2	Web Interface Screens.....	251
8.2.1	Overview of Web Function.....	251
8.2.2	Homepage.....	251
8.2.3	System Status Information Area.....	252
8.2.4	System Specifications Information Area.....	252
8.2.5	Controller Specifications Information Area.....	252
8.2.6	Site Information Area.....	252
8.2.7	Alarms Area.....	253
8.2.8	System Status Area.....	253
8.2.9	Menu Navigation Area.....	259
<b>9</b>	<b>Replacement Procedures.....</b>	<b>274</b>
9.1	Controller Replacement.....	274
<b>10</b>	<b>Controller Digital Input and Relay Output Connections.....</b>	<b>276</b>
10.1	Controller Digital Inputs.....	276
10.2	Controller Relay Outputs.....	276
10.3	IB2 (Controller Interface Board) and EIB (Controller Extended Interface Board).....	276
<b>11</b>	<b>Specifications.....</b>	<b>277</b>

## Admonishments Used in this Document



**DANGER!** Warns of a hazard the reader **will** be exposed to that will **likely** result in death or serious injury if not avoided. (ANSI, OSHA)



**WARNING!** Warns of a potential hazard the reader **may** be exposed to that **could** result in death or serious injury if not avoided. This admonition is not used for situations that pose a risk only to equipment, software, data, or service. (ANSI)



**CAUTION!** Warns of a potential hazard the reader **may** be exposed to that **could** result in minor or moderate injury if not avoided. (ANSI, OSHA) This admonition is not used for situations that pose a risk only to equipment, data, or service, even if such use appears to be permitted in some of the applicable standards. (OSHA)



**ALERT!** Alerts the reader to an action that **must be avoided** in order to protect equipment, software, data, or service. (ISO)



**ALERT!** Alerts the reader to an action that **must be performed** in order to prevent equipment damage, software corruption, data loss, or service interruption. (ISO)



**FIRE SAFETY!** Informs the reader of fire safety information, reminders, precautions, or policies, or of the locations of fire-fighting and fire-safety equipment. (ISO)



**SAFETY!** Informs the reader of general safety information, reminders, precautions, or policies not related to a particular source of hazard or to fire safety. (ISO, ANSI, OSHA)

# Important Safety Instructions

## Safety Admonishments Definitions

Definitions of the safety admonishments used in this document are listed under “Admonishments Used in this Document” on page viii.

## General Safety



**DANGER!** YOU MUST FOLLOW APPROVED SAFETY PROCEDURES.

Performing the following procedures may expose you to hazards. These procedures should be performed by qualified technicians familiar with the hazards associated with this type of equipment. These hazards may include shock, energy, and/or burns. To avoid these hazards:

- a) The tasks should be performed in the order indicated.
- b) Remove watches, rings, and other metal objects.
- c) Prior to contacting any uninsulated surface or termination, use a voltmeter to verify that no voltage or the expected voltage is present. Check for voltage with both AC and DC voltmeters prior to making contact.
- d) Wear eye protection.
- e) Use certified and well maintained insulated tools. Use double insulated tools appropriately rated for the work to be performed.

## Personal Protective Equipment (PPE)



**DANGER!** ARC FLASH AND SHOCK HAZARD.

Appropriate PPE and tools required when working on this equipment. An appropriate flash protection boundary analysis should be done to determine the “hazard/risk” category, and to select proper PPE.



Only authorized and properly trained personnel should be allowed to install, inspect, operate, or maintain the equipment.

Do not work on LIVE parts. If required to work or operate live parts, obtain appropriate Energized Work Permits as required by the local authority, per NFPA 70E “Standard for Electrical Safety in the Workplace”.

## Handling Equipment Containing Static Sensitive Components



**ALERT!** Installation or removal of equipment containing static sensitive components requires careful handling. Before handling any equipment containing static sensitive components, read and follow the instructions under “Static Warning” on page x.

## Static Warning



This equipment contains static sensitive components. The warnings listed below must be observed to prevent damage to these components. Disregarding any of these warnings may result in personal injury or damage to the equipment.

1. Strictly adhere to the procedures provided in this document.
2. Before touching any equipment containing static sensitive components, discharge all static electricity from yourself by wearing a wrist strap grounded through a one megohm resistor. Some wrist straps have a built-in one megohm resistor; no external resistor is necessary. Read and follow wrist strap manufacturer's instructions outlining use of a specific wrist strap.
3. Do not touch traces or components on equipment containing static sensitive components. Handle equipment containing static sensitive components only by the edges that do not have connector pads.
4. After removing equipment containing static sensitive components, place the equipment only on static dissipative surfaces such as conductive foam or ESD bag. Do not use ordinary Styrofoam or ordinary plastic.
5. Store and ship equipment containing static sensitive components only in static shielding containers.
6. If necessary to repair equipment containing static sensitive components, wear an appropriately grounded wrist strap, work on a conductive surface, use a grounded soldering iron, and use grounded test equipment.

# 1 Introduction

## 1.1 Preface

These instructions describe the complete functionality of the Vertiv™ NetSure™ Mini Control Unit Controller. Some functionality is dependent on hardware connected to the controller. Your system may not utilize all the functionality described.

Refer also to the controller Configuration Drawing (C-drawing) furnished with your system for a list of factory default settings.



**NOTE!** These instructions reflect a controller in a -48 VDC output system. For a controller in a +24 VDC output system, refer to the controller Configuration Drawing (C-drawing) furnished with your system for a list of factory default settings.

When the controller is used in an inverter only system (only inverters are installed in the system), the Web pages are different. Refer to “Inverter Only System” on page 251 for Web page descriptions for an inverter only system.

## 1.2 Overview

The controller performs the following functions:

- Rectifier Control, including an Energy Optimization Mode
- Solar Converter Control
- Converter Control
- Inverter Control
- System Components Monitoring and System Alarms Generation (including recording alarms in logs)
- Operating Data Acquisition and Data Logs
- Battery Management
- Energy Management via Energy Optimization Mode
- Power Split Feature
- AC Generator Function
- Diesel Management Feature
- Hybrid Control Function (Supporting Generator, Solar and Wind Energy Input, and Optimization).
- Supervisory Module (SM Modules) Monitoring
- Maximum Current Limit Function
- Communications Function
- FIAMM SoNick (Sodium Nickel) Battery Interface
- Radius Server Feature

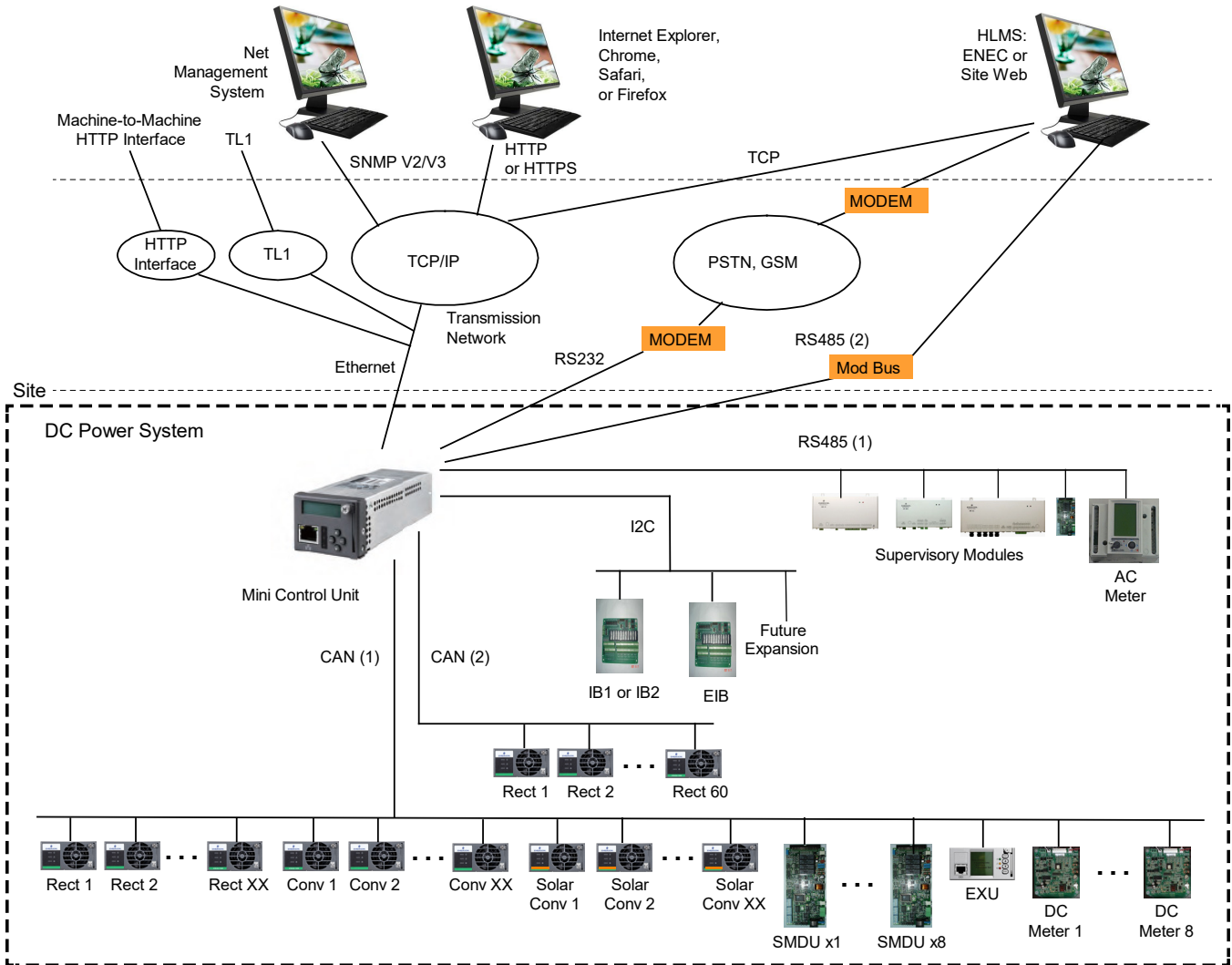
The controller controls the system automatically via configured parameters.

A User can interface with the controller locally using the local keypad and display or locally/remotely using the Web Interface.

The controller can also be accessed via SNMP (v2 and v3) or TL1 (over Ethernet). A machine-to-machine HTTP interface is also available.

Figure 1.1 illustrates the various applications that can be used to interface with the controller.

**Figure 1.1 Interfacing with the Controller**



## 1.3 Function Descriptions

### 1.3.1 Rectifier, Solar Converter, Converter, Inverter Control

The controller controls rectifiers, solar converters, converters, and inverters automatically.



**NOTE!** Solar Mode has to be enabled for controller control of solar converters (see “Enabling Solar Mode” on page 32).



**ALERT!** The controller can be equipped in a system that can either have +24V DC-DC converters installed or -58V DC-DC converters installed. The system cannot have both types of converters installed at the same time.



### 1.3.2 System Components Monitoring and System Alarms Generation

The controller monitors the components comprising the system (such as the rectifiers, solar converters, converters, inverters, and supervisory modules) and generates alarms if a fault condition occurs. The controller also maintains an alarm history log.

The available system alarms are programmed with an Alarm Severity Level. Each Alarm Severity Level has different visual/audible alarm attributes. Available Alarm Severity Levels and their attributes are listed in Table 1.1.

The available system alarms can also be mapped to alarm relays (located on controller interface boards) that can be wired to external alarm circuits.

**Table 1.1 Alarm Severity Levels**

Alarm Severity Levels	Red LED	Yellow LED	Audible Alarm Buzzer
Critical Alarm (CR)	ON	--	ON
Major Alarm (MJ)	ON	--	ON
Minor Alarm (MN)	OFF	ON	OFF
No Alarm (NA)	OFF	OFF	OFF

- **Alarm Status Setting:** Indicates if the alarm is active or not active, and the severity level if active. The available alarm status settings are as follows.
  - **Critical Alarm:** The fault endangers the power systems continued function.
  - **Major Alarm:** The fault reduces the power systems functionality.
  - **Minor Alarm:** Special operating condition.
  - **No Alarm:** The alarm is disabled, and no alarm is given.
- The alarm indicator turns OFF if the fault(s) that triggered the alarm clears.
- The audible alarm can be silenced by pressing any key on the controller's local interface pad. The audible alarm is also silenced if the fault(s) that triggered the alarm clears.
- An audible alarm cutoff feature can be programmed that silences the audible alarm after a preset programmable time period. The audible alarm can also be disabled.

### 1.3.3 Operating Data Acquisition and Data Logs

The controller acquires and analyses real time data from the system's components such as the rectifiers, solar converters, converters, inverters, and supervisory modules.

The controller uses this data to process alarms and also records data in logs. The logs are viewed using the Web Interface and consists of the following. Logs can be saved in the .html (Web page) or .txt (text) format.

Data History Log/Event Log/Alarm History Log: There is a maximum of 60,000 data points recorded between these logs.

- **Alarm History Log:** Records 4000 latest alarms. The Web Interface displays the latest 500 items.
- **Battery Test Log:** Up to ten (10) battery discharge tests can be recorded.
- **Event Log:** Records 4000 latest events. The Web Interface displays the latest 500 items.
- **Data History Log:** The Web Interface displays the latest 500 items, and you can upload a file with up to the latest 6,000 items in a single date range. Use multiple date ranges to upload more than 6,000 items.
- **System Log:** Records 3000 items in run log. The Web Interface displays the latest 500 items.

- **Diesel Test Log:** Records 500 latest diesel test results.



**NOTE!** For all logs except the **Battery Test Log**, once maximum number of log entries is reached, new entries overwrite the oldest entries.

### 1.3.4 Battery Management

The controller provides the following battery management functions.

- Battery Charge Temperature Compensation
- Battery Equalize Charge
- Battery Charge Current Limit
- High and Low Battery Temperature Alarms
- Battery Thermal Runaway Management (BTRM) Feature (Reduces Voltage during a High Battery Temperature Condition)
- Battery Discharge Test
- Battery Test Logs (maximum ten [10] tests saved)
- Battery LVD (Low Voltage Disconnect)
- Battery Capacity Prediction
- Battery Block and Battery Midpoint Monitoring
- Thermal Runway Detection and Management



**NOTE!** Battery management functions are not available for controller configurations that enable controller capability to receive status information sent from FIAMM SoNick (Sodium Nickel) batteries.

#### **Battery Charge Temperature Compensation**

The controller can be programmed to automatically increase or decrease system output voltage to maintain battery float current as battery temperature decreases or increases, respectively. Battery life can be extended when an optimum charge voltage to the battery with respect to temperature is maintained. Temperature is monitored by a sensor mounted on the battery. See your power system documentation for temperature sensor information. You can also set high and low compensation temperature alarms.

#### **Functional Description (See Figure 1.2):**

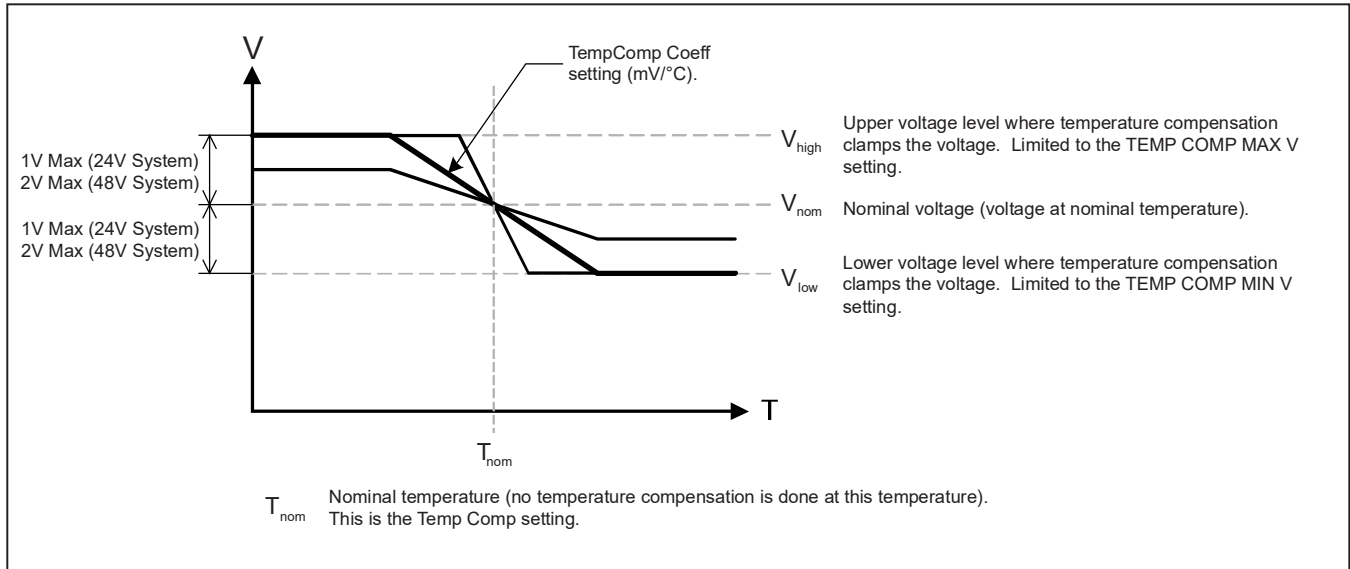
Battery charge temperature compensation adds a correction term, related to the temperature of the batteries, to the nominal value of the system voltage. The degree of regulation (TempComp Coeff), expressed in mV/°C/battery string, can be set per battery manufacturer recommendations.

To protect batteries and voltage-sensitive loads, compensation is automatically limited to a maximum of two volts (48V systems) or one volt (24V systems) above or below the nominal output level (float setting). Temperature compensation can be set to clamp lower than this by enabling the Temperature Compensation Clamp feature. When enabled, temperature compensation will clamp if the battery temperature reaches either the Temp Comp Max Voltage setting or the Temp Comp Min Voltage setting.

Temperature compensation is automatically disabled if communication between the controller and all rectifiers is lost, a DC over or under voltage alarm activates, a low voltage disconnection occurs, manual mode is entered, or the system enters the equalize or test modes.

Refer to “Specifications” on page 277 for temperature probe and reading accuracy.

Figure 1.2 Temperature Compensated Voltage Control



### Battery Equalize Charge and Battery Charge Current Limit

The controller can increase system output voltage for equalizing the charge on all battery cells of a conventional flooded cell battery, or for recharging the battery following a commercial power failure.

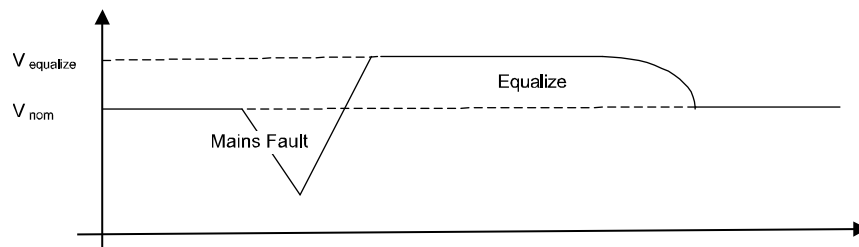
The charging function can be initiated cyclically (scheduled), automatically, or manually.

Refer to the battery manufacturer's instructions for equalize charging instructions.

#### Functional Description (See Figure 1.3):

- Start of Charging:** When the battery charge current exceeds a preset value for three (3) minutes or if the calculated battery capacity has decreased to a preset value (after a commercial AC failure, for example), the charging function of the controller is activated. A charging signal is sent from the controller to the rectifiers to increase the voltage up to the battery charging level  $V_{equalize}$ .
- Battery Current Limitation:** After a commercial AC failure or when some battery cells are permanently damaged, the current to the batteries can be quite extensive. To avoid overheating or further damages to the battery, the controller limits the battery current to a preset level by limiting the charging voltage of the rectifiers. Should the battery current still exceed a higher preset value, an alarm is issued. Battery charge current is limited to the value set in the controller, as long as battery voltage is above 47 VDC.
- End of Charging:** When the charging current drops below a preset value, a defined prolonged charging time is started before the charging is stopped and the voltage of the rectifiers return to the float charging level ( $V_{nom}$ ). For safety, there is an equalized charging limit time that stops the charging after a preset time.

Figure 1.3 Voltage Characteristics on Commercial AC Failure and Automatic Equalize Charging



## High and Low Battery Temperature Alarms

The controller can monitor battery temperature via a temperature sensor mounted on a battery cell. Values for high battery temperature and low battery temperature alarms can then be programmed into the controller.

## Battery Thermal Runaway Management (BTRM) Feature

The Battery Thermal Runaway Management (BTRM) feature reduces voltage during a high battery temperature condition.

You can designate a temperature sensor as the BTRM sensor. The BTRM sensor has High 2 and High 1 BTRM temperature alarm limits. If battery temperature exceeds the “BTRM Temp High 2” setting, system voltage is lowered to the BTRM voltage setting. This feature can also be disabled.

## Battery Discharge Test and Battery Test Logs

The controller can perform battery discharge tests to check the condition of the battery(s). There are three (3) types of battery discharge tests:

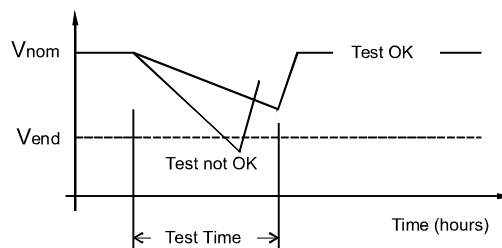
- Battery Test without Constant Current
- Battery Test with Constant Current
- Short Time Test (requires two battery shunts)

A User can manually start a battery discharge test or program the controller to automatically start battery discharge tests at scheduled intervals. Twelve (12) Constant Current Tests can be scheduled by the month-day-hour. A Short Time Test can be scheduled to be performed every 1-365 days. During a battery discharge test, the controller controls the rectifiers output to place the entire load or partial load on the batteries. The controller monitors the discharge of the battery and saves the results in a battery test log. The controller stores ten (10) battery discharge tests.

### Functional Description:

For manual battery discharge tests as well as for scheduled battery discharge tests, the following parameters must be set: End Test Voltage, End Test Time, and End Test Capacity. See Figure 1.4.

Figure 1.4 Battery Test Diagram



### Battery Discharge Test Sequence:

- For a Constant Current Test, the output voltage of the rectifiers is reduced so that the batteries supply the preset Constant Current Test Current to the load.
- If Constant Current is disabled, then the current being delivered by the batteries will be dependent on the load.
- For a Short Time Test, the output voltage of the rectifiers is reduced so that only the batteries power the load. If the batteries fail, the rectifiers power the load.
- The battery test continues until one of the following occurs:
  - The preset End Test Time, see Figure 1.4, expires. The battery has passed the test.
  - The battery capacity drops below the preset End Test Capacity. The battery has passed the test.

- The battery voltage drops below the preset End Test Voltage (Vend) (see Figure 1.4). The battery has not passed the test and the test is interrupted. A bad battery alarm is activated.
  - If a critical alarm occurs during the test or there's not enough load, the battery test is aborted. In such cases a "Battery Test Fail" alarm will be activated (indicating the test couldn't be done). This alarm is different from the "Bad Battery" alarm (meaning the test was completed but the battery didn't pass it).
- A battery test alarm is active during a battery discharge test.
  - If the battery has not passed the test, a bad battery alarm is activated.
  - After the battery discharge test, the output voltage of the rectifiers increases so that the rectifiers supply the system and charge the batteries.



**NOTE!** A procedure for performing a manual battery discharge test is provided on page 42.

### **Battery LVD (Low Voltage Disconnect)**

To prevent serious damage to the batteries during a commercial AC power failure, the batteries can be disconnected by voltage or time control.

The batteries are reconnected automatically when commercial AC power is restored, and a predetermined DC voltage level is reached.

See "LVD Tab Programmable Parameter Descriptions" on page 145 for descriptions of programmable LVD parameters.

### **Battery Capacity Prediction**

The controller can predict battery capacity. When a battery is connected to the system at initial setup or increasing the number of batteries, you need to update the Battery Ah rating. After doing this and making sure the battery is fully charged you need to reset the battery capacity used percentage by performing the "Reset Battery Capacity" command to tell the controller that the batteries are 100% charged. From this point forward the controller will keep track of the battery current and time to predict the battery capacity used.

### **Battery Block and Battery Midpoint Monitoring**

The controller can monitor battery blocks (12 V blocks) or midpoint battery voltage of battery strings connected to the EIB (Controller Extended Interface Board) assembly. An alarm is issued when either battery block voltage or battery midpoint voltage is abnormal.

### **Thermal Runaway Detection and Management**

#### **Functional Description:**

The system uses several control mechanisms to avoid thermal runaway.

- During a short high-rate discharge, the batteries will normally get hot. The controller takes this into consideration. After completion of the discharge duty, the batteries are recharged with a limited current to avoid heating the batteries any further.
- The temperature of the batteries can be monitored, and the controller sets the charge voltage appropriately, as previously described under "Battery Charge Temperature Compensation" on page 4.
- In addition to battery temperature compensation, if battery temperature rises above a set temperature limit, the system stops battery charging completely by lowering the output voltage to the "BTRM Voltage" setting. This allows the batteries to cool down. The system also provides alarm notification of this occurrence. Power supplied to customer equipment is not interrupted. See "Setting Battery Thermal Runaway Management (BTRM) Feature" on page 34 for programming.
- The battery LVD circuits can be programmed to open (disconnect) if a high temperature event occurs (HTD-High Temperature Disconnect). The contactor(s) open when battery temperature rises above a programmable value and close

again when battery temperature falls below another programmable value. See “LVD Tab Programmable Parameter Descriptions” on page 145 for programming.

### 1.3.5 Energy Management

Energy Management consists of an Energy Optimization Mode.

#### **Energy Optimization Mode**

The controller provides an Energy Optimization Mode (ECO) function. Energy Optimization permits an installation to only operate rectifiers as needed to maintain the load and keep batteries in a fully charged condition. As load increases, Energy Optimization turns on additional rectifiers as needed to maintain the load. As load decreases, Energy Optimization places rectifiers in standby to conserve energy usage. Rectifiers which are always operating to maintain any load requirements are cycled through the group of rectifiers controlled by this feature to provide uniform operating times for each rectifier.



**ALERT!** The Energy Optimization Mode should NOT be used in systems that operate without batteries.



**NOTE!** *If the battery is ever disconnected, disable Energy Optimization Mode until the battery is reconnected.*

The following operating conditions apply:

1. The ECO mode is only enabled upon normal system operation. If any of the following alarms occurs, the system cannot enter or will exit the ECO mode.
  - a) Current imbalance (only when imbalance current protection is enabled).
  - b) AC fail.
  - c) Any one rectifier over temp.
  - d) Any one rectifier AC fail.
  - e) Any one rectifier fault.
  - f) Any one rectifier over voltage.
  - g) Any one rectifier fan fault.
  - h) Any one rectifier no response.
  - i) Any one battery fuse open.
  - j) Any one LVD disconnect.
  - k) Battery is in charge or discharge, as defined below:
    - Battery current > [battery rated capacity × 0.005], or battery current > 5A means battery in charge.
    - Battery current < [battery rated capacity × -0.003], or battery current < -2A means battery in discharge.
  - l) Under voltage.
  - m) Any one rectifier in current limit mode.
2. The system load cannot exceed the system energy saving point (default value is 45%). Otherwise the system cannot enter or will exit the ECO mode.

3. When the rectifier load exceeds its optimal operating point, the system will exit the ECO mode and the controller will recalculate and then turn off any unnecessary rectifiers. After that, the system can enter the ECO mode again.
4. If the system enters the ECO mode and then exits for five consecutive times within one hour, an abnormal alarm (ECO Cycle Alarm) will be generated, and the system can no longer enter the ECO mode until the ECO Cycle Alarm is cleared manually or retires automatically after 24 hours.

### 1.3.6 Power Split Feature

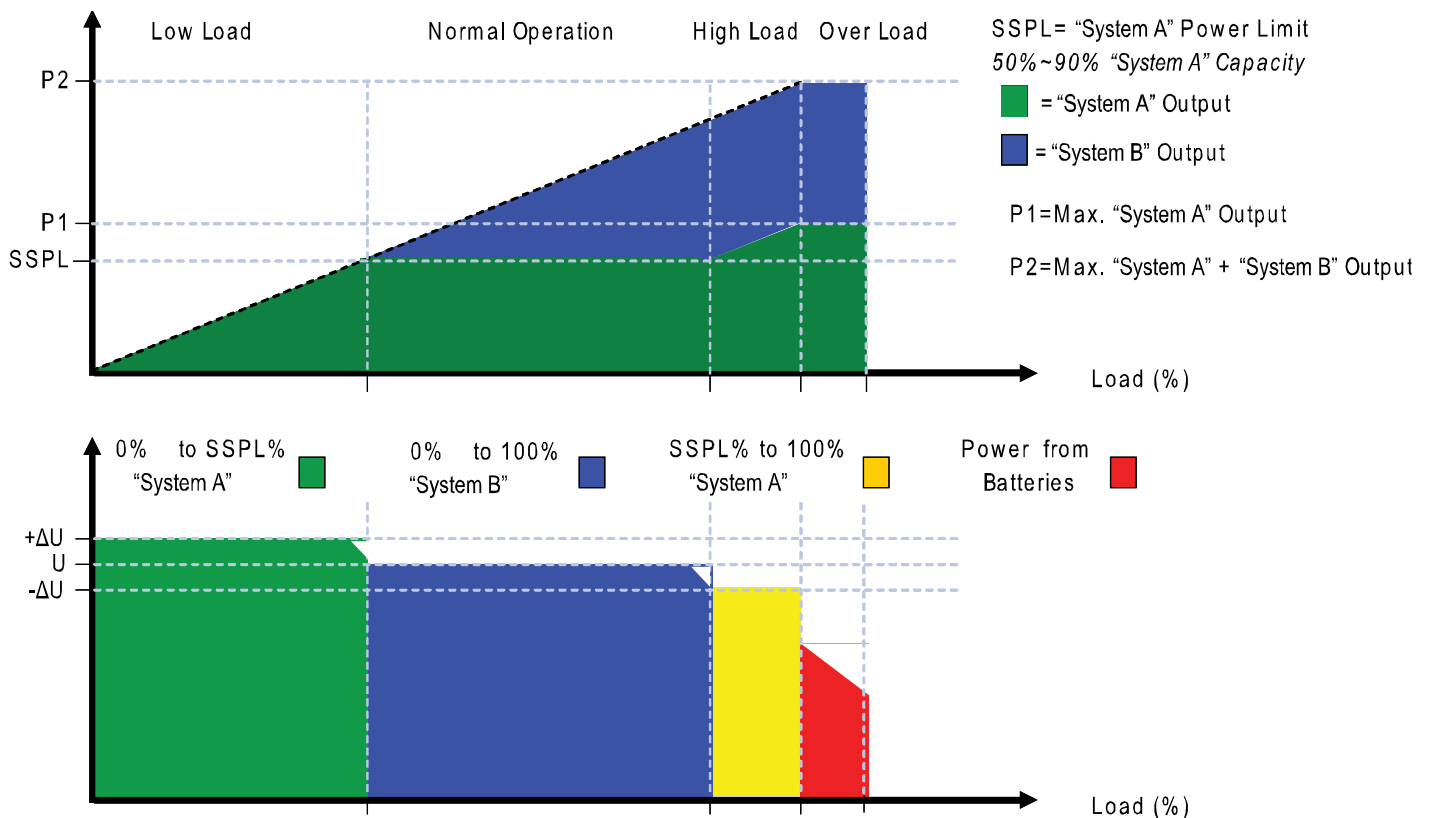
The Power Split feature allows you to connect the power system controlled via the controller to an existing DC power system instead of extending or completely replacing the existing DC power system.

The power system controlled via the controller functions as “System A” to share load (split output) with the existing system (“System B”) that requires expansion. The controller does not require communication with the “System B’s” controller.

The Power Split feature provides for the sharing of total load in a controlled manner between the paralleled power systems.

When Power Split is programmed, the controller adjusts rectifier output voltage per load demands to ensure proper sharing between “System A” and “System B”. See Figure 1.5.

Figure 1.5 Power Split Feature



### 1.3.7 AC Generator Function

This is a special feature to control an AC generator using the controller by either a voltage threshold or a battery capacity threshold. The control occurs from a User designated relay located on the IB2 or EIB board. When this generator relay is activated, this means the generator should turn “On”. Criteria for the generator function is to start the generator when either the output voltage (AC

Generator Start Voltage setting) or battery capacity (AC Generator Start Capacity setting) decreases to the set point. Once this occurs, an alarm called “Automatic AC Generator Run” is activated, the relay changes state, and the generator is told to start. The generator runs for a period of time and is then turned off after the Auto Equalize feature of the controller finishes.

Auto Equalize looks for two (2) specific conditions for activation.

1. Has the recharge current (provided either by the rectifiers or solar converters) exceeded a User settable Equalize Start Current value for three (3) minutes or
2. Has the battery capacity decreased to a User settable value.

If either of the above conditions are reached, Auto Equalize activates and the controller tells the rectifiers and solar converters (if present) to provide their respective output equalize voltages. Auto Equalize will deactivate once the battery recharge current reaches the Equalize Stop current level and the Equalize Stop Delay has been satisfied. Once equalize has finished, the generator will also shut off if it is running.

In addition to the automatic features above, this Generator Function will provide a way to manually run the generator with a setting to run the generator for (10 minutes, 1 hour, 8 hours, or No Limit) when necessary. Although not necessary for operation, the function will also have the capability for recognizing a digital input signal that can be used to send feedback to the controller that the generator is running.

See “**AC Generator Function:**” starting on page 138.

### 1.3.8 Diesel Management Feature

The Diesel Management feature is available when an SM-AC supervisory module is connected to the controller. The Diesel Management feature consists of a Diesel Test. The Diesel Test can be performed at specific intervals, or a User can manually start the Diesel Test. The controller records the test results.

### 1.3.9 Hybrid Control Function (Supporting Generator, Solar and Wind Energy Input, and Optimization)

Hybrid Control is designed for use in new installations or as an upgrade of existing sites powered by a diesel generator(s) when grid power is not available. The Hybrid control is also applicable to sites with highly unreliable or frequently unavailable grid power connection. The primary power source is still considered to be the diesel generator(s). Since grid power is always given priority, the primary power source is still considered to be the grid power.



**NOTE!** *The Hybrid Control function requires a specific configuration. Hybrid Control menus will not normally be displayed unless your controller has been configured by Vertiv for this function. Contact Vertiv for a Hybrid Control configuration.*

#### **General**

Hybrid Control allows the option of selecting one of the following: Fixed Daily Time based operation or Capacity Discharge based operation.

**Fixed Daily Time** based operation is intended to be used with a combination of AC powered active cooling (air conditioners) and DC powered cooling (heat exchangers, etc.). The cycle period is synchronized to the 24hrs day-night cycle. It makes optimum use of the different temperature conditions during the day and the night in order to facilitate Hybrid fuel saving operation.

**Capacity Discharge** based operation is intended for sites utilizing only DC powered cooling (heat exchangers, etc.). The cycle period is determined by User selectable depth of discharge (DOD) of the batteries per cycle, and associated recharge time. It provides optimum Hybrid fuel saving operation.

**Operation from Grid Power** is performed with both Fixed Daily Time and Capacity Discharge modes of operation. Grid power is always given priority when available.



As the two types of control are specific to the hardware configuration of the site, the Fixed Daily Time or Capacity Discharge is a User selectable option on installation.

## Hybrid Operation

**Generator Control:** A potential free relay contact output from the controller interface board controls the start and stop of the diesel generator. The signal will be generated by the controller and operates according to the Hybrid software mode of operation. The default control logic (User selectable) is as follows:

- Energized Output Relay - Generator OFF
- De-energized Output Relay – Generator ON

This is a fail-safe logic to ensure generator operation in all cases where power or control to the relays is lost.

In addition, the type of signal to the Generator can be selected as N/O (Normally Open) or N/C (Normally Closed) by selecting the relevant output pins of the control relay.

**Number of Generator Control Outputs:** The controller Hybrid software can control one or two generators. Each generator control is designated as DG1 or DG2 output. The User can select DG1, or DG2, or DG1 and DG2. When both are selected they will be alternatively used (two generators operation).

**Diesel Fail Alarm:** A diesel fail alarm will be generated if the Diesel Generator ON signal fails to bring the generator to operation and provide the system with AC power. Alarm will be triggered after 60 seconds (default value, settable) from ON signal. If two generator operation is selected, the second Diesel Generator ON signal will be activated simultaneously with the Diesel Fail alarm.

**Battery Fuse Trip Alarm:** In the event of a Battery Fuse trip condition, an alarm will be generated.

### Under Voltage Alarms:

- **Under Voltage Alarm 1:** If voltage decreases below the Under Voltage Alarm 1 setting, an alarm is raised.
- **Under Voltage Alarm 2:** If voltage decreases below the Under Voltage Alarm 2 setting, the Diesel Generator is started and an alarm is raised.

**LVD 1:** Normal loads are disconnected.

**LVD 2:** Priority loads are disconnected.

**Charge Voltage:** Refer to Figure 1.6.

**Equalize Charge:** The battery will be recharged at the equalize voltage. This is the voltage set in the initial phase of battery recharge. See Figure 1.6.

As the voltage limit is reached, the charge current is gradually reduced – this effect is known as current tail. When the current tail falls below a threshold level, additional equalize charge time is added and then the recharge ends.

The equalize charge current tail threshold is settable from 0.002 to 0.02. Default setting is 0.01 (1 A per 100 Ah). The additional equalize charge time is settable from 1 hour to 24 hours (settable in minutes from 0 to 1440), default setting is 3 hours. The duration of the equalize charge is the time from the start of the recharge to the end of the additional time. (Maximum charge time, determined from the time charge starts, is settable in the range of 1 hour to 48 hours, default setting is 18 hours).

The end of recharge is determined by a three (3) step approach:

- Step1 - calculated battery capacity exceeds 90%. Calculation is performed by measurement of battery current and time, in Ah.
- Step 2 - charge current tail threshold is reached.

- Step 3 - additional charge time is completed.

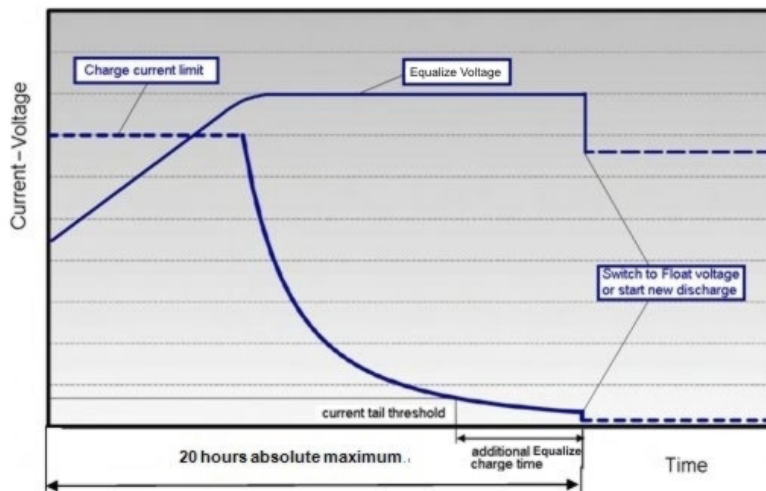
**Float Charge:** Default float voltage is 54.0 V at 20°C with a temperature compensation of 72 mV per °C.

If battery temperature exceeds the BTRM Temp High 2 alarm set point, the charge voltage is reduced to 48 V to reduce gassing and prevent thermal runaway. The same is applicable as well for equalizing charge.

**Equalizing Charge Cycle:** As the cyclic use does not ensure complete battery recharge after every cycle, an equalizing charge cycle is added. The equalizing cycle is settable for every 2 to 365 days intervals, default setting is 100 days. Equalizing charge time is 12 hours independent of discharge time setting. Equalizing charge is performed at equalize voltage until end of additional equalize time and thereafter at float voltage for the remaining time. Also see Figure 1.6.

Equalize charge independently settable 0-1440 min (already set in equalize charge).

**Figure 1.6 Charge Voltage**



### **Early Termination of the Discharge Periods**

**During discharge, over temperature and under voltage conditions will interrupt the discharge and change the operation to charge with the Diesel Generator ON.**

**Over Temperature:** The diesel generator will start and run for a period before it is stopped again. The run time is User selectable in the range 30 to 120 minutes, default setting is 60 minutes. Temperature is referenced to cabinet/shelter ambient temperature sensor connected to controller, not battery temperature. Over temperature start can be disabled completely from the Settings menu.

**Under Voltage:** The under voltage start is triggered by under voltage alarm 2 voltage settings.

The diesel generator will start and run until the normal recharge cycle is due to finish depending on selected mode of operation.

**Under Voltage with Fixed Daily Time:** If the normal recharge cycle is from 7am until 7pm and under voltage has started the Diesel Generator at 5:30am, the effective recharge will be from 5:30am until 7pm.

**Under Voltage with Capacity Discharge:** If this mode is selected, the recharge will terminate.

### **Operation with Grid Power**

Grid power is always used when available. If grid power becomes available during battery discharge, the discharge cycle is terminated and recharge cycle is initiated. If grid power becomes available during diesel generator operation, the diesel generator is switched OFF and operations continue on grid power.

**Battery Recharge with Grid Power:** Battery recharge with grid power can start from the beginning (when grid power becomes available during battery discharge) or can continue from diesel generator recharge, depending on the timing. In both cases, the recharge process will follow the recharge profile shown in Figure 1.6. If battery becomes fully recharged and grid power is still present, the operations will continue to be powered from grid and no battery discharge will be initiated for the duration of grid availability. In this case, battery voltage will revert back to Float voltage.

**Battery Discharge after Grid Failure:** At the point of grid power failure, the battery capacity is unknown as these events occur in random manner. For the purpose of maximizing the use of grid power and in anticipation of grid power becoming available again, the Hybrid operation will continue with battery discharge cycle. Discharge will continue until:

- The preset discharge time elapses (Fixed Daily Time)
- The preset DOD is reached (Capacity Discharge)

In both cases, the discharge can be terminated earlier as described in “Early Termination of the Discharge Periods” on page 12.

### **Relay Assignment – when in Hybrid Mode**

**Relay 1:** Generator Alarm.

No Generator Voltage Alarm. No AC supply, 60 sec delay.

**Relay 2:** Battery Alarms.

Logic alarm generated from: under voltage 1, under voltage 2, LVD1, LVD2, battery high temp, battery very high temp, overvoltage 1, overvoltage 2, battery temp sensor fail, battery fuse alarms and high load alarm.

**Relay 3:** Rectifier Alarms.

Logic alarm generated from: multiple rectifier fail, rectifier fail, rectifier fan failure, rectifier HVSD, rectifier AC failure and rectifier not responding.

**Relay 4:** System Alarms.

Logic alarm generated from: load fuse alarms, high ambient temperature, ambient temp sensor fail; smoke detected, and water detection.

**Relay 5:** Generator Run at High Temp.

Output to intelligent cooling devices linked to AC supply (DG run).

**Relay 6:** Intruder Alarm.

Alarm triggered by dry contact door/motion sensor.

**Relay 7:** Diesel 1 in Operation.

Output to DG1 on site. DG is set on for the duration of the signal.

**Relay 8:** Diesel 2 in operation.

Output to DG2 on site. DG is set on for the duration of the signal.

### **Fixed Daily**

In this mode of operation, the total duration of a complete cycle is 24hrs. This duration is necessary as the operation is synchronized with day-night temperature pattern. When an extended recharge cycle is required, its termination will still follow the 24hrs schedule.

**Cycle Duration:** A complete cycle consists of discharge and charge periods during the combined total of 24hrs. The discharge period starts at 7pm. It is then followed by recharge period (Diesel Generator ON) for the remainder of the 24hrs. The discharge time is User selectable in the range 1hrs to 22hrs, default setting is 12hrs.

**Discharge:** The discharge start time and duration are settable. Discharge period starts at 7pm. The discharge time is User selectable in the range 1hours to 22hours, default setting is 12 hours.

**Recharge:** Recharge period (Diesel Generator ON) follows after discharge for the remainder of the 24hrs. Recharge is performed at equalize voltage until added equalize time elapses and at float voltage for the remaining charge time.

**High Load Alarm:** In order to identify conditions where the load requirements are exceeding the dimensioning of the Hybrid site, an alarm will be generated. The alarm will be triggered when the maximum capacity per discharge cycle is exceeded. The threshold value will be set as default to 40% of battery capacity. It will require capacity measurement per cycle. The alarm will be set once the high load threshold value is reached and is reset at the beginning of the next discharge period. This alarm will help the User identify the root cause of the under voltage condition: high demand load, the loss of capacity due to battery aging, or insufficient charge capacity.

### **Capacity Discharge**

The cycle period is determined by User selectable capacity discharge of the batteries and associated recharge times. The cycle repeats continuously. It does not follow a 24hrs pattern.

**Capacity Discharge and Recharge:** The battery discharge period is determined by the percentage of the nominal battery capacity [Ah] that will be discharged per cycle.

The depth of discharge [DOD] per cycle is User selectable in the range 20% to 80%. Default setting is 60%. The value is set as battery capacity at the end of each discharge period. Therefore, if a 60% discharge is chosen, the discharge value is set to 40%.

The time to recharge to full battery capacity depends on battery capacity at the start of the charge cycle and the available recharge current.

When the additional charge time has been reached; the generator will be stopped, the recharge cycle will end, and discharge cycle will be initiated.

For practical purposes, the battery capacity at the end of every recharge period is set to 100% as long as Step1, Step 2, and Step 3 have elapsed.

If end of charge is not reached within the set maximum hours, the recharge will be terminated and discharge cycle will be initiated.

## **1.3.10 Supervisory Module (SM Modules) Monitoring**

Various devices (supervisory modules) can be connected to the controller to extend its monitoring capabilities.

### **1.3.11 Maximum Current Limit Function**

The current available from the rectifiers can be limited (in AMPS) from 10% to 121% of combined rectifier capacity. The factory setting is 121% unless otherwise specified. The current available from the converters can be programmed (in AMPS) from 50% to 116% of combined converter capacity. The factory setting is 116% unless otherwise specified. Refer to the controller Configuration Drawing (C-drawing) supplied with your system documentation for your system's settings.

See also "Checking the Controller's Current Limit Point after Adding or Removing a Rectifier or Converter Module" on page 31.

### **1.3.12 Communications Function**

The controller is able to communicate with different equipment or, connect to different equipment for communication. See Figure 1.7.

- a) 10M/100M Ethernet Port: The controller can communicate with a supervisory computer or other devices through its 10M/100M Ethernet port. The communication cable shall be a shielded cable. The Ethernet port is located on the front panel of the controller. This port supports Dynamic Host Configuration Protocol (DHCP) function.



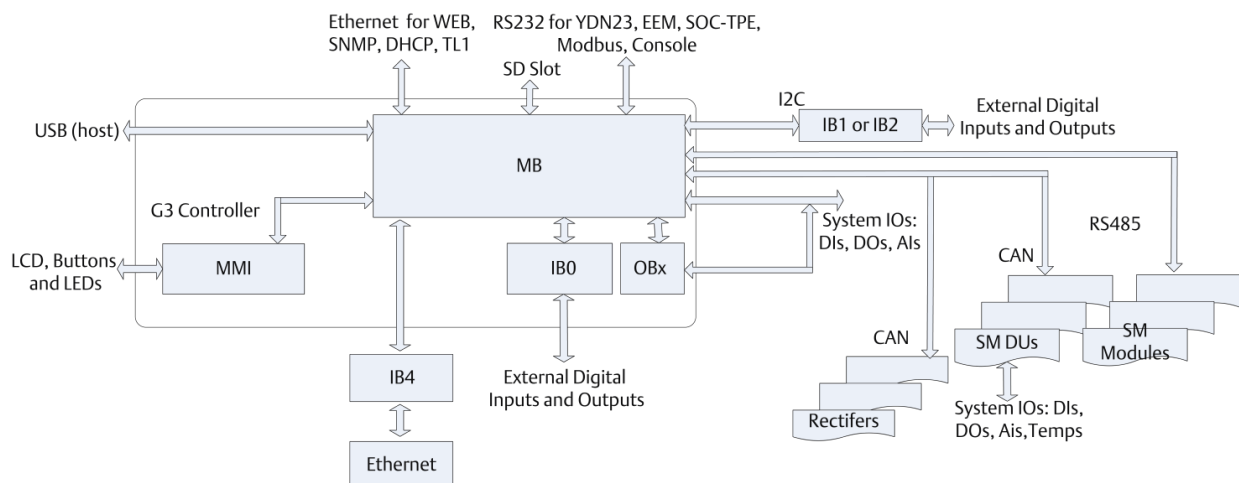
**NOTE!** Some systems may have an IB4 board with a second Ethernet port. The IB4 board is connected to the controller's backplane connector (USB) via a factory provided cable. Refer to your system's documentation for location of the IB4 board (if furnished).

- b) **Controller Digital Inputs:** The controller provides (via system interconnect connectors, refer to your system documentation for location) connections for two (2) programmable binary digital inputs (located on the controller). See also “Controller Digital Input and Relay Output Connections” on page 276.
- c) **Controller Relay Outputs:** The controller provides (via system interconnect connectors, refer to your system documentation for location) connections for four (4) programmable form-C relay outputs (located on the controller). The relay outputs can be connected to customer external alarm circuits. Each relay output can be configured to change state when one or more alarm events occur. The relay outputs can also be connected to customer external equipment, so that the relay output can control or interface with the customer external equipment. See also “Controller Digital Input and Relay Output Connections” on page 276.
- d) **IB2 (Interface Board) and EIB (Extended Interface Board):** Some systems may have an IB2 (Interface Board) and/or EIB (Extended Interface Board) connected to the controller. Each IB2 board provides eight (8) dry relay outputs. Each EIB board provides five (5) dry relay outputs. Every relay output has a set of NC (normally close) and NO (normally open) contacts.
- The relay outputs can be connected to customer external alarm circuits. Each relay output can be configured to change state when one or more alarm events occur.
- The relay outputs can also be connected to customer external equipment, so that the relay output can control or interface with the customer external equipment.
- e) **IB4 (Interface Board 4):** Some systems may have an IB4 board. The IB4 board is a USB to LAN converter for the controller, which includes a USB and an Ethernet port. The IB4 board is connected to the controller’s backplane connector (USB) via a factory provided cable. Refer to your system’s documentation for location of the IB4 board (if furnished).
- f) **RS-485 Port:** The controller can communicate with an SM-AC, SM-Bat, or SMIO through the RS-485 port. The RS-485 port uses the parameters 19200, n, 8, 1.
- g) **Modbus Protocol:** The controller can communicate with an AC Meter using the Modbus protocol.
- h) **TL1:** See “TL1 Interface” starting on page 54.
- i) **Machine-to-Machine HTTP Interface:** See “Machine-to-Machine HTTP Interface” starting on page 55.

### 1.3.13 FIAMM SoNick (Sodium Nickel) Battery Interface

If a special configuration file is furnished, the controller has capability to receive status information sent from FIAMM SoNick (Sodium Nickel) batteries. See “FIAMM SoNick (Sodium Nickel) Batteries Interface” starting on page 52.

**Figure 1.7 The Controller Perspective**



### 1.3.14 Radius Server Feature

When the radius server feature is enabled and a User attempts to login using the LCD or web page, the controller first checks the username/password entered for a match programmed in the controller. If the controller authenticates, then the controller grants the User access. This step is to allow a login in case the radius server is not available, has changed, etc.

If the authentication fails (either not present or wrong password), then the controller checks the username/password entered using the radius interface. If the controller authenticates, then the controller grants the User access. If authentication fails, the controller notifies the User and does not grant the User access.

If an IB4 board is present, the radius messages are sent to the IB4 network interface; otherwise, the radius messages are sent to the front (craft) port.

The controller uses vendor-specific attributes to select the User's level of access. The Vertiv vendor id is 6302. The vendor-specific attribute is VV-Priv, which is a string with 4 possible values:

- Administrator: Administrator
- Browser: Browser
- Operator: Operator
- Engineer: Engineer

Here is the dictionary definition of this Vertiv vendor-specific attribute:

```
VENDOR      Vertiv      6302
BEGIN-VENDOR Vertiv
ATTRIBUTE    VV-Priv     1          string
END-VENDOR   Vertiv
```

If the server responds with an unknown Service-Type, the controller will record the event in the system log and act as though access was rejected, per RFC 2865.

The controller does not support the Access-Challenge response from the server. If this response is received, it is ignored.

The radius server settings are programmed using the Web Interface. Admin privilege level access is required.

## 2 Operation

### 2.1 Controller Initialization

The controller goes through an initialization process when power is initially applied to the system.



**NOTE!** The initialization routine takes several minutes. During that time various alarm indicators may illuminate on the controller's front panel and an audible alarm may sound. Disregard all alarms. An audible alarm can be silenced at any time by momentarily depressing the ENT key on the controller.

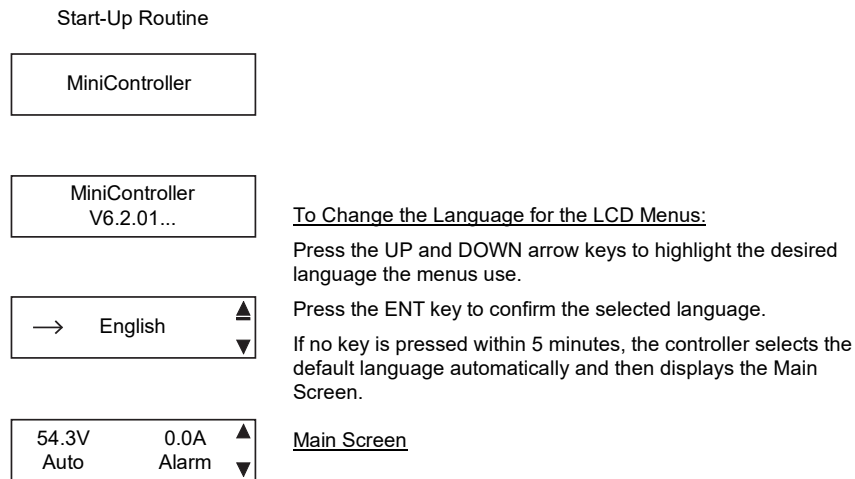


**NOTE!** The controller does not turn off any relay when the controller is reset/replaced. If the relay is active when the controller is reset/replaced, it will stay active whether or not the alarm condition still exists. If possible, the alarm condition should be cleared before the controller is reset/replaced. If the alarm is not cleared, after starting the controller, it may be necessary to manually trigger an alarm condition to clear all alarm relays.

#### Initialization

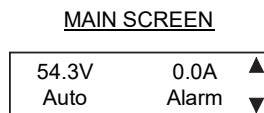
1. After the controller is powered on, it goes through an initialization routine. See Figure 2.1.
2. When initialization is complete, the language screen appears. Press the UP or DOWN arrow key to select the desired language. Press the ENT key to confirm the selection. See Figure 2.1.

Figure 2.1 Controller Start-Up



3. The MAIN SCREEN displays. See Figure 2.2.

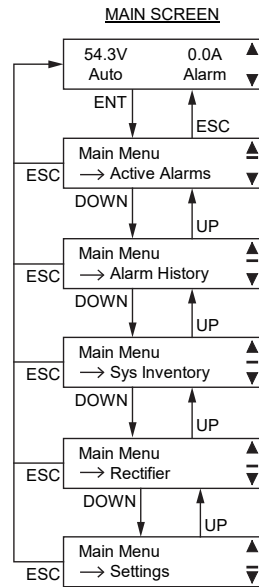
Figure 2.2 Controller Local Display MAIN SCREEN



To reboot the Controller, from the Main Screen press the ENT and ESC keys at the same time. Release both keys. Press ENT to confirm.

4. From the MAIN SCREEN, press the ENT key to go to the MAIN MENU. See Figure 2.3.

Figure 2.3 Controller Local Display MAIN MENU



- From the MAIN MENU, you can press the UP and DOWN arrow keys to select a submenu. Press the ENT key to enter the selected submenu.



**NOTE!** Repeatedly press the ESC key to return in reverse order level by level from any submenu until the MAIN SCREEN appears.

## 2.2 Controller’s Front Panel Indicators

There are three (3) indicators located on the controller’s front panel. Refer to Figure 2.4. Refer to Table 2.2 for the function of the indicators.

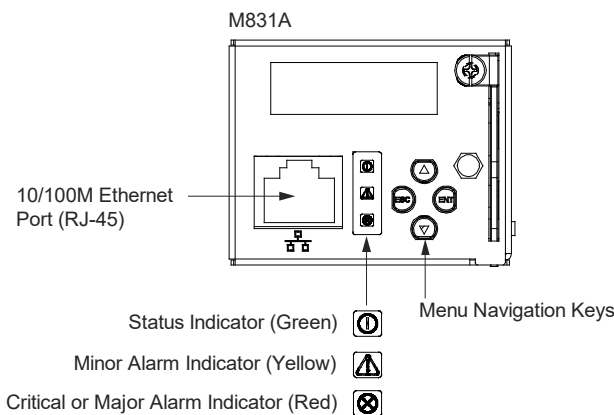
## 2.3 Controller’s Front Panel Menu Navigation Keys and Local Display

There are four (4) menu navigation keys and a local display located on the controller’s front panel. Refer to Figure 2.4. Refer to Table 2.3 for the function of the menu navigation keys.






**NOTE!** When the local display is lit, if no button is pushed for eight (8) minutes, the backlight of the local display extinguishes, and the controller returns to the MAIN SCREEN. Press any key to re-activate the local display.

Figure 2.4 Controller’s Front Panel Indicators and Menu Navigation Keys Locations







**Table 2.2 Controller's Front Panel Indicators**

Indicator	Normal State	Fault State	Fault Cause
 Status (Green)	On	Off	No input power to the controller.
 Minor Alarm (Yellow)	Off	On	The system has one or more active minor alarms. Alarm conditions are programmable.
 Major or Critical Alarm (Red)	Off	On	The system has one or more active major or critical alarms. Alarm conditions are programmable.

**Table 2.3 Controller's Front Panel Menu Navigation Keys**

Key Symbol	Key Name	Function
ESC	Escape	Press this key to go back to a previous menu or to cancel setting a parameter.
ENT	Enter	Press this key to go forward to the next menu, to select a parameter to edit, or to validate a parameter setting change.
	Up Arrow	Press the up or down arrow keys to scroll through the menus or to change the value of a parameter.
	Down Arrow	

Press any key to silence an audible alarm.

## 2.4 Passwords and Privilege Levels

### Local Keypad and Display

Anyone can browse the controller via the local keypad and display. A User Name and Password is required to change settings. User Names and associated passwords are programmed into the controller via the Web Interface. To change settings locally, a User Name and Password for a User with an access level of Level B (Operator) or higher is required. See “Users Tab” on page 166. Once a password is entered locally, it remains in effect for a preset time period to allow navigating between menus without re-entering the password.

### Web Interface

Web interface access always requires a User name and password to be entered to gain access.

**Web Interface User Privilege Levels:** Users are programmed with a “privilege level” (see **Table 5.1** on page 168). Each privilege level gives a User Web access to specific menus, as shown in **Table 5.2** on page 168. A User has access to his/her level menus, plus all menus of the lesser privilege levels.

## 2.5 Multiple Languages Supported

Multiple languages are supported in the Local Interface and Web Interface. Refer to “Language Tab” on page 180.

## 2.6 Using the Local Keypad and Display

See also “Passwords and Privilege Levels” on page 19.

## 2.6.1 Local Menu Navigation Keys and Local Display

See “Controller’s Front Panel Menu Navigation Keys and Local Display” on page 18.

## 2.6.2 Local Display Menus

Refer to “Local Display Menus” on page 80.

## 2.6.3 Navigating the Local Display Menus

### **To Select a Sub-Menu**

From the MAIN SCREEN, press the ENT key to go to the MAIN MENU.

From the MAIN MENU, press the UP and DOWN keys to highlight the desired sub-menu.

Press the ENT key to enter the selected sub-menu.

### **To Select a User and Enter a Password (Settings Menus)**

To select a User, use the UP and DOWN arrow keys to select a User previously programmed into the controller. Press ENT to select the User. Note that only Users programmed into the controller are shown. Users are programmed via the Web Interface.

To enter a password, use the UP and DOWN keys to choose a character. Press ENT to accept and move to the next character. Continue this process until all characters are entered. Press ENT again to accept the password. Default Password: 640275

### **To Change a Parameter (Settings Menus)**

Press the UP and DOWN keys to move up and down the list of parameters.

Press ENT to select the parameter.

Press the UP and DOWN keys to change the parameter.

Press ENT to make the change. Press ESC to cancel the change.

## 2.7 Using the Web Interface

See also “Passwords and Privilege Levels” on page 19.



**NOTE!** *The controller supports a 10/100M Ethernet connection.*

### 2.7.1 Overview

Via the Web Interface, a User (with proper access level) can:

- View real-time operating information (rectifiers, solar converters, converters, inverters, AC, DC, batteries, etc.).
- View and download information recorded in logs.
- Send control commands.
- Set programmable parameters.
- Download and upload the “SettingParam.tar” file.
- Download firmware to the controller.

### 2.7.2 Supported Browsers

Multiple browsers are supported in the Web Interface. The User can use Chrome, Safari, or Firefox.

### 2.7.3 Web Interface Screens

Refer to “Web Interface Screens” on page 101.

## 2.7.4 Logging into the Controller via Web Interface Access

Multiple browsers are supported. The User can use Chrome, Safari, or Firefox.

### Procedure

1. In your browser, enter http:// and the controller's IP address (see "Connecting a Local Computer Directly to the Controller when the System is NOT Equipped with an IB4 Board" on page 23 or "Connecting a Local Computer Directly to the Controller when the System IS Equipped with an IB4 Board" on page 25) and press **ENTER**. If your site requires secure HTTP and you were furnished with a controller configuration with secure HTTP, enter https:// and the controller's IP address and press **ENTER**.
2. If this is the first time the controller is accessed remotely, the following screen appears. This informs a User to change the default password the first time the controller is accessed remotely. If the below procedure was performed, for subsequent logins the window in the next step appears.
  - a) Enter the old password (default 640275).
  - b) Enter a new password.
  - c) Re-enter the new password.
  - d) Click the "Confirm Button".



**NOTE!** By default, the "User Name" is "admin" and the "Password" is "640275". See also "Users Tab" on page 166.

3. The following Web Interface Login window opens. Enter a valid **User Name** and **Password**, then click **LOGIN**.



**NOTE!** Before entering a User Name and password, you can select a local language that the Web Interface menus use from those listed in the top right corner of the login window. See "Language Tab" on page 180.

4. After entering a valid **User Name** and **Password** and clicking **LOGIN**, the Web Interface "HOMEPAGE" window opens. Refer to "Web Interface Screens" on page 101.

## 2.8 Setup Procedures

### 2.8.1 Setting IPv4 Communications Parameters (if controller not set as DHCP)

The controller's IPv4 parameters (IP, subnet mask, and gateway addresses) must be set to match your company's network settings. The default settings for these parameters are shown below.

- IP Address: 192.168.1.2
- Subnet Mask Address: 255.255.255.0
- Gateway Address: 192.168.1.1

#### **Local Menu Navigation:**

Main Menu / Settings / Communication / enter parameters.

#### **Web Menu Navigation:**

Advance Settings Menu / Ethernet Tab / enter parameters.

### 2.8.2 Setting IPv6 Communications Parameters (if controller not set as DHCPv6)

The controller's IPv6 parameters (IPv6 address, IPv6 prefix, and IPv6 gateway address) must be set to match your company's network settings. The default settings for these parameters are shown below.

- Link-Local Address: fe80:209:f5ff:fe09:1002/64
- IPv6 Address: 20fa:fffd:fffc:fffb:ffa:fff9:fff8:fff7
- IPv6 Prefix: 0
- IPv6 Gateway: 20fa:1:fffe:ffff:fffe:ffff:ffff:fffe

#### **Local Menu Navigation:**

Main Menu / Settings / Communication / enter parameters.

#### **Web Menu Navigation:**

Advance Settings Menu / Ethernet Tab / enter parameters.

### 2.8.3 Setting for DHCP and DHCPv6

The DHCP and DHCPv6 functions allow the controller to acquire an IP address automatically. This function can only be enabled or disabled via the local display and keypad. If this function is enabled and the acquisition of an IP address fails, an alarm is generated. If the acquisition of an IP address is successful, you need to record the IP address automatically acquired by the controller to access the controller via the Web Interface. This IP address is displayed on the main system info screen (Main Menu / ESC) in the IP Address field or in the local display menu (Main Menu / Settings Icon / Comm Settings) in the IP Address field below the DHCP setting.

#### **Local Menu Navigation:**

Main Menu / Settings / Communication / DHCP (set to enabled) (can also view acquired IP address).

Main Screen / ESC / ENT (to view acquired IP address).

#### **Web Menu Navigation:**

None.

## 2.8.4 Connecting the Controller to your Local Area Network (LAN) when the System is NOT Equipped with an IB4 Board

An Ethernet port is located on the front panel of the controller. This port supports Dynamic Host Configuration Protocol (DHCP) function.

### Procedure

1. If your system **does not have** an IB4 board, connect the Local Area Network (LAN) to the controller's front panel port. This port can be assigned an IP address or can be set for DHCP. If set for DHCP, it will get its IP address from a DHCP server on the network. Refer to "Setting IPv4 Communications Parameters (if controller not set as DHCP)" on page 22 or "Setting IPv6 Communications Parameters (if controller not set as DHCPv6)" on page 22 to set the port parameters;  
or,  
"Setting for DHCP and DHCPv6" on page 22 to set the port as DHCP or DHCPv6.

## 2.8.5 Connecting the Controller to your Local Area Network (LAN) when the System IS Equipped with an IB4 Board



**NOTE!** Your system may be furnished with an IB4 board. The IB4 board provides a second Ethernet port. The Ethernet port located on the controller's front panel can **ONLY** be used to connect a computer directly to the controller. The Ethernet port located on the IB4 board can be used to connect the controller to your Local Area Network (LAN). Refer to your system's documentation for location of the IB4 board (if furnished).



**NOTE!** If your system has an IB4 board, **DO NOT** connect your Local Area Network (LAN) to the controller front Ethernet port.

Some systems may have an IB4 board with a second Ethernet port. This port supports Dynamic Host Configuration Protocol (DHCP) function. Refer to your system's documentation for location of the IB4 board (if furnished).

### Procedure

1. If your system **has** an IB4 board, connect the Local Area Network (LAN) to the IB4 board port. The IB4 board port can be assigned an IP address or can be set for DHCP. If it is set for DHCP, it will get its IP address from a DHCP server on the network. Refer to "Setting IPv4 Communications Parameters (if controller not set as DHCP)" on page 22 or "Setting IPv6 Communications Parameters (if controller not set as DHCPv6)" on page 22 to set the port parameters;  
or,  
"Setting for DHCP and DHCPv6" on page 22 to set the port as DHCP or DHCPv6.

## 2.8.6 Connecting a Local Computer Directly to the Controller when the System is NOT Equipped with an IB4 Board

An Ethernet port is located on the front panel of the controller. This port supports Dynamic Host Configuration Protocol (DHCP) function.

If your system **does not have** an IB4 board, perform the following procedure.

### Procedure

1. Before connecting your computer directly to the controller's Ethernet port, use the following procedure to record your computer's network settings (so they can be returned to these values when done) and then change these settings in your computer to match the communications settings programmed in the controller.
  - a) Record your computer's network settings.
  - b) Record whether the IP settings are set to automatic (DHCP) or are manually set. If manually set, also record the following:

IP Address: \_\_\_\_\_  
 Subnet Mask: \_\_\_\_\_  
 Default Gateway: \_\_\_\_\_

- c) Record the following controller’s IP parameters. If these parameters were not changed, they should be at the default values as shown in the example section below.

IPv4

IP Address: \_\_\_\_\_  
 Subnet Mask: \_\_\_\_\_  
 Default Gateway: \_\_\_\_\_

Example:

IP Address: 192.168.1.2  
 Subnet Mask: 255.255.255.0  
 Default Gateway: 192.168.1.1

IPv6

IPv6 Address: \_\_\_\_\_  
 IPv6 Prefix: \_\_\_\_\_  
 IPv6 Gateway: \_\_\_\_\_

Example:

IPv6 Address: 20fa:ffff:ffc:ffb:ffa:fff9:fff8:fff7  
 IPv6 Prefix: 0  
 IPv6 Gateway: 20fa:1:ffff:ffff:ffff:ffff:ffff:ffff

- d) Change your local computer’s network settings using the information you acquired in the above step, except that the last part of the IP address needs to be replaced with any different number.

IPv4

IP Address: \_\_\_\_\_  
 Subnet Mask: \_\_\_\_\_  
 Default Gateway: \_\_\_\_\_

Example:

IP Address: 192.168.1.3  
 Subnet Mask: 255.255.255.0  
 Default Gateway: 192.168.1.1

IPv6

IPv6 Address: \_\_\_\_\_  
 IPv6 Prefix: \_\_\_\_\_  
 IPv6 Gateway: \_\_\_\_\_

Example:

IPv6 Address: 20fa:ffff:ffc:ffb:ffa:fff9:fff8:fff7  
 IPv6 Prefix: 0  
 IPv6 Gateway: 20fa:1:ffff:ffff:ffff:ffff:ffff:ffff

- e) Note that you may have to reboot your local computer for the settings to take effect. Follow any instruction you see on the screen.
2. Connect your computer directly to the controller’s Ethernet port (RJ-45 jack located on the front of the controller). See Figure 2.4. The controller’s front panel port is configured with an IP address. Default is 192.168.1.2. This is the address you will type into your Web browser to access the controller’s Web Interface. You will also have to set the properties on your computer (refer to the previous procedure in step 1).
  3. When finished, disconnect your computer from the controller and, if necessary, reset your computer network settings as recorded in step 1.

## 2.8.7 Connecting a Local Computer Directly to the Controller when the System IS Equipped with an IB4 Board



**NOTE!** Your system may be furnished with an IB4 board. The IB4 board provides a second Ethernet port. The Ethernet port located on the controller's front panel can **ONLY** be used to connect a computer directly to the controller. The Ethernet port located on the IB4 board can be used to connect the controller to your Local Area Network (LAN). Refer to your system's documentation for location of the IB4 board (if furnished).

An Ethernet port is located on the front panel of the controller. This port supports Dynamic Host Configuration Protocol (DHCP) function.

Some systems may have an IB4 board with a second Ethernet port. Refer to your system's documentation for location of the IB4 board (if furnished).

If your system **has** an IB4 board, perform the following procedure.

### **Procedure**

1. Connect your computer directly to the controller's Ethernet port (RJ-45 jack located on the front of the controller). See Figure 2.4. The controller's front panel port will have the following IPv4 Address: 192.168.100.100. Enter the address 192.168.100.100 in your Web browser to access the controller's Web Interface via IPv4. The controller's front panel port will have the following IPv6 Address. IPv6 Link-Local Address: fe80::209:f5ff:fe09:1002/64 or IPv6 Address: 20fa:fffd:fffc:fffb:ffa:fff9:fff8:fff7. Enter the IPv6 Link-Local Address: [fe80::209:f5ff:fe09:1002/64] or IPv6 Address: [20fa:fffd:fffc:fffb:ffa:fff9:fff8:fff7] to access the controller's Web Interface via IPv6.
2. When finished, disconnect your computer from the controller.

## 2.9 Common Tasks Performed via the Local Keypad and/or Web Interface

### 2.9.1 General

Refer also to "Local Display Menus" on page 80 and "Web Interface Screens" on page 101 for menu item descriptions.



**NOTE!** Ensure current configuration is backed up prior to changing settings (see "Backing Up the Controller Configuration" on page 42). Create new backup files after every successful update for your records and in case of controller failure.



**NOTE!** If you add or remove hardware from the system (except rectifiers, solar converters, converters, and inverters), update the inventory via the "Auto Config" menu item (see "Updating the Controller's Device Inventory" on page 42).



**NOTE!** Some settings are restricted by other settings. Refer to Figure 3.1 for setting restrictions.

### 2.9.2 Reset Admin Password Feature

The factory sets the controller's "Reset Admin Password" feature when the controller is shipped. This feature reminds a User to reset the factory password when the controller is first initialized and also prevents a User from logging in remotely until the default password is changed. Once the default password is changed, this feature turns off automatically. If it is desired to re-activate this feature, from the local display, press the ESC and Down Arrow buttons at the same time. Press ENTER when prompted to activate this feature.

### 2.9.3 Viewing Alarms

#### **Local Menu Navigation:**

Main Menu / Active Alarms / ENT.

**Web Menu Navigation:**

Active alarms are listed at the top of the window. Click on an alarm category to expand the alarm list.

## 2.9.4 Viewing System Status

**Local Menu Navigation:**

Main Screen.

**Web Menu Navigation:**

System status is displayed in the right window pane of the Home page. Select the Power System tab and use the interactive links to view the various device group status pages. See “Device Group Status Pages” starting on page 107.

## 2.9.5 Viewing the Controller’s Device Inventory

**Local Menu Navigation:**

Main Menu / Sys Inventory / ENT to view Inventory.

**Web Menu Navigation:**

System Inventory Menu.

## 2.9.6 Clearing or Resetting Alarms

**Local Menu Navigation:**

Main Menu / Settings / Alarm Setting / select alarm to clear or reset.

**Web Menu Navigation:**

Settings Menu / navigate the various device tabs to select an alarm to clear.

## 2.9.7 Clearing Logs

**Local Menu Navigation:**

None.

**Web Menu Navigation:**

Advance Settings Menu / Clear Data Tab / select log to clear.

## 2.9.8 Changing the Local LCD Display Orientation

The rotation of the text in the local menus can be changed to allow the controller to be mounted in different orientations. If the text is not in the proper orientation for your application, change the LCD Rotation setting.

**Local Menu Navigation:**

None.

**Web Menu Navigation:**

Settings Menu / System Tab / LCD Rotation.

## 2.9.9 Disabling the Local Keypad Sound

**Local Menu Navigation:**

Main Menu / Settings / Sys Settings / Keypad Voice.

**Web Menu Navigation:**

None.



## 2.9.10 Blocking Alarms

### **Local Menu Navigation:**

Main Menu / Settings / Alarm Setting / Alarm Blocked.

### **Web Menu Navigation:**

Settings Menu / System Tab / Outgoing Alarms Blocked.

## 2.9.11 Changing the Date and Time

### **Local Menu Navigation:**

Main Menu / Settings / Sys Settings / Date.

Main Menu / Settings / Sys Settings / Time.

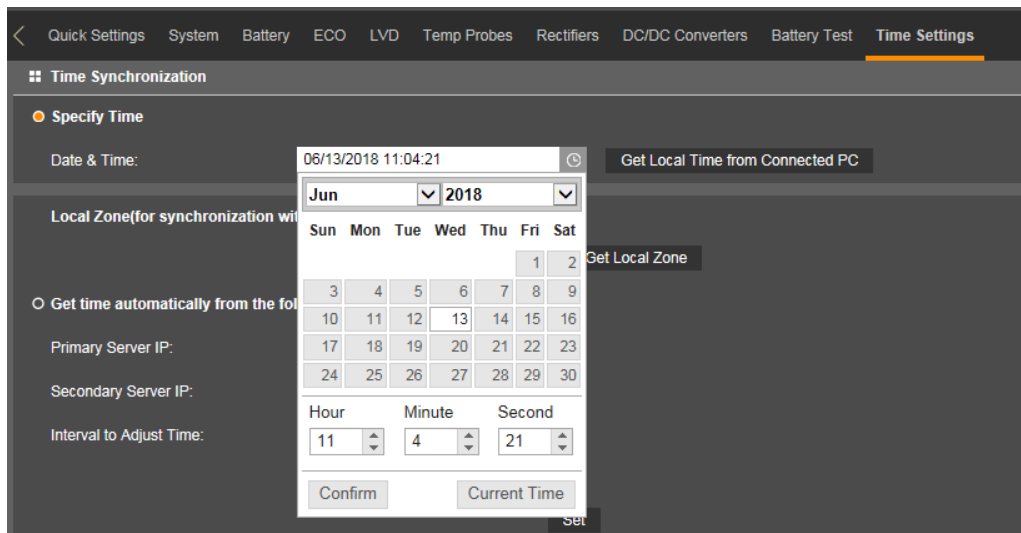
To enter a Date or Time, press ENT. Use the UP and DOWN keys to choose a character. Press ENT to accept and move to the next character. Continue this process until all characters are entered. Press ENT again to accept the date or time. Press ESC to cancel.

### **Web Menu Navigation:**

Settings Menu / Time Settings Tab.

In the Specify Time section, click on "Get Local Time from Connected PC" and then "Set" to automatically set the date and time. To manually set the date and time, click on "the clock symbol" and enter the date and time. See Figure 2.5. Then select the "Confirm" button. Then click on "Set" to save the change.

**Figure 2.5 Manual Date and Time Menu**



## 2.9.12 Adding, Deleting, and Modifying Users

### **Local Menu Navigation:**

None.

### **Web Menu Navigation:**

Advance Settings Menu / Users Tab.

## 2.9.13 Setting IP Communications Parameters (if controller not set as DHCP or DHCPv6)

See also "Setting IPv4 Communications Parameters (if controller not set as DHCP)" on page 22 and "Setting IPv6 Communications Parameters (if controller not set as DHCPv6)" on page 22.

**Local Menu Navigation:**

Main Menu / Settings / Communication / enter parameters.

**Web Menu Navigation:**

Advance Settings Menu / Ethernet Tab / enter parameters.

## 2.9.14 Setting for DHCP and DHCPv6

**Local Menu Navigation:**

See “Setting for DHCP and DHCPv6 on page 22.

**Web Menu Navigation:**

None.

## 2.9.15 Setting SNMP Parameters

**Local Menu Navigation:**

None.

**Web Menu Navigation:**

Advance Settings Menu / SNMP Tab.

## 2.9.16 Setting TL1 Parameters

Refer to the following procedures.

### **Setting TL1 Protocol Parameters**

**Local Menu Navigation:**

None.

**Web Menu Navigation:**

Advance Settings Menu / Monitor Protocol Tab (set to TL1), then click the “Valid after Restart” button. Set the TL1 protocol parameters as described under “TL1 Protocol” on page 217.

### **Setting TL1 Access Identifiers and Sub-Access Identifiers**

**Local Menu Navigation:**

None.

**Web Menu Navigation:**

Advance Settings Menu / TL1 AID Group Tab. Set the TL1 access identifiers and sub-access identifiers as described under “TL1 AID Group Tab” on page 219.

### **Enabling/Disabling and Configuring Pre-Defined TL1 Signals**

**Local Menu Navigation:**

None.

**Web Menu Navigation:**

Advance Settings Menu / TL1 AID Signal Tab. Assign signals to the TL1 access identifiers as described under “TL1 AID Signal Tab” on page 221.

## 2.9.17 Setting Auto Equalize

### **Local Menu Navigation:**

Main Menu / Settings / Batt Settings / Auto EQ.

Also enter additional parameters from Web Interface (Settings Menu / Battery Tab / enter parameters)

### **Web Menu Navigation:**

Settings Menu / Battery Tab / Automatic Equalize (set to Yes) then enter the following parameters.

- Equalize Start Current
- Equalize Start Capacity
- Equalize Stop Current
- Equalize Stop Delay Time
- Maximum Equalize Charge Time

## 2.9.18 Programming the Audible Alarm Feature

### **Local Menu Navigation:**

Main Menu / Settings / Alarm Setting / Audible Alarm.

### **Web Menu Navigation:**

Settings Menu / System Tab / LCD Audible Alarm.

## 2.9.19 Manually Forcing LVDs

### **Local Menu Navigation:**

Main Menu / Settings / Maintenance / “Auto/Man” State (change to Manual).

then

Main Menu / Settings / Maintenance / LVD 1 Control or LVD 2 Control (select the other state).

then

Main Menu / Settings / Maintenance / LVD 1 Control or LVD 2 Control (select the original state).

then

Main Menu / Settings / Maintenance / “Auto/Man” State (change to Auto).

### **Web Menu Navigation:**

Settings Menu / System Tab / “Auto/Manual” State (change to Manual).

then

Settings Menu / LVD Tab / LVD 1 Control or LVD 2 Control (select the other state).

then

Settings Menu / LVD Tab / LVD 1 Control or LVD 2 Control (select the original state).

then

Settings Menu / System Tab / “Auto/Manual” State (change to Auto).

## 2.9.20 Manually Forcing Relays

After completing the following steps, the relay will momentarily toggle to the chosen state. The relay then reverts back to being controlled by the controller.



**NOTE!** This may take a few minutes.

See also “Using the Relay Test Feature” on page 40.

**Local Menu Navigation:**

None.

**Web Menu Navigation:**

Settings Menu / System Tab / “Auto/Manual” State (change to Manual).

then

Advance Settings Menu / DO (relay) / Relay (select the other state) then press the SET button.

then

Settings Menu / System Tab / Power System / “Auto/Manual” State (change to Auto).

## **2.9.21 Assigning Severity Level to Alarms**

**Local Menu Navigation:**

None.

**Web Menu Navigation:**

Advance Settings Menu / Alarms Tab and DI Alarms Tab.

## **2.9.22 Assigning Relays to Alarms**

**Local Menu Navigation:**

None.

**Web Menu Navigation:**

Advance Settings Menu / Alarms Tab and DI Alarms Tab.

## **2.9.23 Placing the System in Float or Equalize Charge Mode**

**Local Menu Navigation:**

Main Menu / Settings / Maintenance / “EQ/FLT Control”.

**Web Menu Navigation:**

Settings Menu / Battery Tab / “Equalize/Float” Charge Control.

## **2.9.24 Viewing/Changing the Float Voltage Setting**

**Local Menu Navigation:**

Main Menu / Settings / Batt Settings / Float Voltage.

**Web Menu Navigation:**

Settings Menu / Battery Tab / Float Charge Voltage.

## **2.9.25 Viewing/Changing the Equalize Voltage Setting**

**Local Menu Navigation:**

Main Menu / Settings / Batt Settings / EQ Voltage.

**Web Menu Navigation:**

Settings Menu / Battery Tab / Equalize Charge Voltage.

## 2.9.26 Setting Battery Parameters



**NOTE!** Some parameters are not available for controller configurations that enable controller capability to receive status information sent from FIAMM SoNick (Sodium Nickel) batteries.

### **Local Menu Navigation:**

Main Menu / Settings / Batt Settings / navigate menus and enter parameters.

### **Web Menu Navigation:**

Settings Menu / Battery Tab / enter parameters.

## 2.9.27 Setting Battery Capacity Parameters



**NOTE!** After setting the battery capacity, the User should also reset the battery capacity (battery must be fully charged). (from the Web Interface; Settings Menu / Battery Tab / Reset Battery Capacity) (from the Local Interface; Settings Menu / Batt Settings / Reset Batt Cap).

### **Local Menu Navigation:**

Main Menu / Settings / Batt1 Setting or Batt2 Setting / Rated Capacity.

### **Web Menu Navigation:**

Settings Menu / Battery Tab / Batt1 Rated Capacity.

or

See “Individual Battery Settings Page” on page 126.

## 2.9.28 Setting Rectifier High Voltage Shutdown

### **Local Menu Navigation:**

None.

### **Web Menu Navigation:**

Settings Menu / Rectifiers Tab / HVSD (set to enabled) then set HVSD Limit.

## 2.9.29 Setting Solar Converter High Voltage Shutdown

### **Local Menu Navigation:**

None.

### **Web Menu Navigation:**

Settings Menu / Solar Tab / HVSD Limit.

## 2.9.30 Setting Rectifier Current Limit

### **Local Menu Navigation:**

Main Menu / Settings / Rect Settings / Current Limit (set to enabled) then set Curr Limit Pt.

### **Web Menu Navigation:**

Settings Menu / Rectifiers Tab / Current Limit (set to enabled) then set Current Limit Point.

## 2.9.31 Checking the Controller’s Current Limit Point after Adding or Removing a Rectifier or Converter Module

If a rectifier or converter module is added; the respective current limit point in amps will automatically increase to maintain the same percentage. For example, if the current limit was set to 100% of combined capacity and a module is added, the new current limit setpoint will be 100% of the combined capacity including the new module.

If a rectifier or converter is removed from the system (and the Rect Comm Fail or Conv Comm Fail alarm is cleared); the respective current limit point will remain unchanged unless the capacity of the remaining rectifiers or converters is not sufficient to maintain this current limit point. If that happens, the current limit point will automatically decrease to the maximum (121% of the remaining rectifiers or 116% of the remaining converters).

It is recommended that the current limit point be checked whenever a rectifier or converter module is added to or removed from the power system.

When setting total rectifier or total converter current limit, the set point to each unit is the total set point divided by the number of units. For example, if the system contains five rectifiers and the current limit is set to 150 amps then each rectifier has a current limit set point of 30 amps. If one or more rectifiers or converters are removed or fails, it will take several seconds for the individual set points to the remaining rectifiers or converters to be reset. In the example given, if one rectifier is removed the current limit set point will drop to 120 amps (30 amps times four remaining rectifiers) until the controller can send updated set points to the remaining rectifiers. This takes a couple communication cycles (several seconds) after which each rectifier would have a new set point of 37.5 amps for a total of 150 amps. The total current limit of the rectifiers and converters should not be set such that the loss of the redundant rectifiers or converters will cause this temporary set point to drop below the actual maximum expected load. If batteries are used on the rectifier output, the batteries should support the load until the current limit set points can be re-established due to loss of a rectifier.

### 2.9.32 Enabling Solar Mode

When solar converters are all installed prior to applying power and starting system, the controller will NOT communicate with solar converters until SOLAR MODE is enabled. To enable SOLAR MODE, refer to the following procedure.

#### **Local Menu Navigation:**

None.

#### **Web Menu Navigation:**

Settings / System Tab / Solar Mode / set to “SOLAR” or “RECT-SOLAR” or “Disabled”. Reboot the controller (see “Rebooting the Controller” on page 44).

If you have both rectifiers and solar converters in the system, you have an option to set Solar Mode to “RECT-SOLAR”. In the Battery Settings tab you set the “Float Charge Voltage (Solar)” parameter to the desired float setting. The parameter “Float Charge Voltage (Rect)” setting **MUST** be set 0.3 V lower than the “Float Charge Voltage (Solar)” parameter setting for solar converters to operate properly.

### 2.9.33 Setting Over Voltage Alarm 1

#### **Local Menu Navigation:**

Main Menu / Settings / Other Setting / Over Voltage 1.

#### **Web Menu Navigation:**

Settings Menu / System Tab / Over Voltage 1.

### 2.9.34 Setting Over Voltage Alarm 2

#### **Local Menu Navigation:**

Main Menu / Settings / Other Setting / Over Voltage 2.

#### **Web Menu Navigation:**

Settings Menu / System Tab / Over Voltage 2.

## 2.9.35 Setting Under Voltage Alarm 1

### **Local Menu Navigation:**

Main Menu / Settings / Other Setting / Under Voltage 1.

### **Web Menu Navigation:**

Settings Menu / System Tab / Under Voltage 1.

## 2.9.36 Setting Under Voltage Alarm 2

### **Local Menu Navigation:**

Main Menu / Settings / Other Setting / Under Voltage 2.

### **Web Menu Navigation:**

Settings Menu / System Tab / Under Voltage 2.

## 2.9.37 Setting Temperature Sensors

Temperature sensors may be connected to the...

- System Temperature Ports 1, 2, 3 (if available),
- Temp1 and Temp2 ports on an IB2 Interface Board,
- Temp1 and Temp2 ports on an EIB Interface Board,
- Temp1 through Temp8 ports of up to eight (8) SM-Temp modules, and
- The input block monitoring ports on the SM-DUE modules. See also “Setting the SM-DUE Parameters (if furnished)” on page 38.



**NOTE!** Only the SM DUE designated as SMDUE1 and SMDUE2 via the addressing switches can have temperature probes connected to them.

Each port (sensor) may be set as None, Battery, or Ambient.

A temperature sensor set as an ambient temperature sensor may also be set as the sensor which displays the ambient temperature on the Web Interface’s Homepage.

A temperature sensor set as a battery temperature sensor may also be set as the temperature compensation sensor (in addition, the temperature compensation sensor is the sensor which displays the battery temperature on the Web Interface’s Battery Device Group Status Page).

A temperature sensor set as a battery temperature sensor may also be set as the BTRM (Battery Thermal Runaway Management) sensor (in addition, the BTRM sensor is the sensor which is used for the High Temperature Disconnect [HTD] Feature.)

### **Procedure**

1. Set each temperature sensor in the system to None, Battery, or Ambient.

### **Local Menu Navigation:**

None.

### **Web Menu Navigation:**

Settings Menu / Temp Probes Tab.

Also enter values for the temp probe temperature alarms from the Web Interface (Settings Menu / Temp Probes Tab).

2. If desired, set a temperature sensor set as an ambient temperature sensor as the sensor which displays the ambient temperature on the Web Interface's Homepage.

**Local Menu Navigation:**

None.

**Web Menu Navigation:**

Settings Menu / System Tab / Main Ambient Temp Sensor.

Also enter values for the ambient temperature alarms from the Web Interface (Settings Menu / System Tab).

3. If desired, set a temperature sensor set as a battery temperature sensor as the battery temperature compensation sensor.

**Local Menu Navigation:**

Main Menu / Settings / Batt Settings / TempComp Sensor.

**Web Menu Navigation:**

Settings Menu / Battery Tab / Temp Compensation Probe.

Also enter values for the compensation temperature alarms from the Web Interface (Settings Menu / Battery Tab).

4. If desired, set a temperature sensor set as a battery temperature sensor as the BTRM sensor.

**Local Menu Navigation:**

None.

**Web Menu Navigation:**

Settings Menu / Battery Tab / BTRM Temp Sensor.

Also enter values for the BTRM temperature alarms from the Web Interface (Settings Menu / Battery Tab).

## 2.9.38 Setting Battery Charge Temperature Compensation

The following need to be set for the Battery Charge Temperature Compensation feature.

See above for selecting the battery temperature compensation temperature sensor (or select maximum or average) and setting compensation temperature alarms.

Refer to "Specifications" on page 277 for temperature probe and reading accuracy.

**Local Menu Navigation:**

Main Menu / Settings / Batt Settings / Enter values for TempComp Center and Temp Comp Coeff.

**Web Menu Navigation:**

Settings Menu / Battery Tab.

Enter values for the following parameters:

Temp Compensation Center, Temp Comp Coefficient (slope), Temp Comp Voltage Clamp, Temp Comp Max Voltage, and Temp Comp Min Voltage (note that you have to enable "Temp Comp Voltage Clamp" to set the Temp Comp Max Voltage and Min Voltage values).

## 2.9.39 Setting Battery Thermal Runaway Management (BTRM) Feature

The following need to be set for the Battery Thermal Runaway Management (BTRM) feature.



See above for selecting the Battery Thermal Runaway Management (BTRM) temperature sensor and setting BTRM temperature alarms.

**Local Menu Navigation:**

None.

**Web Menu Navigation:**

Settings Menu / Battery Tab.

Enter values for the following parameters:

“BTRM Action” and “BTRM Voltage”.

**BTRM Temp Delta Alarm**

Set the BTRM feature as described above.

Set an ambient temperature sensor as the sensor which displays the ambient temperature on the Web Interface’s Homepage (see “Setting Temperature Sensors” on page 33).

Enter values for the following parameters:

“BTRM Temp Sensor”, “BTRM Temp High 2”, “BTRM Temp High1”, “BTRM Temp Delta Over Ambient”, “BTRM Temp Delta Alarm”, “BTRM Action” and “BTRM Voltage”.

## **2.9.40 Configuring the Controller Identification of Rectifiers and Assigning which Input Feed is Connected to the Rectifiers**

When rectifiers are all installed prior to applying power and starting the system, the order in which the controller identifies the rectifiers is by serial number (lowest serial number is Rect 1, next lowest is Rect 2, etc.). If you prefer the controller to identify the rectifiers by position in the system, perform the following procedure.

Upon power up, the controller arbitrarily assigns Feed AC1, AC2, or AC3 to each rectifier. This assignment is used to display rectifier AC input feed voltage(s). The User may reassign the feed to each rectifier per your specific installation by following the procedure below.

**Local Menu Navigation:**

None.

**Web Menu Navigation:**

See “Individual Rectifier Settings Page” on page 110 and set the Rectifier ID and AC Feed (repeat for every rectifier).

then

Settings Menu / Rectifiers Tab / “Confirm Rect ID/Feed”.

## **2.9.41 Configuring the Controller Identification of Solar Converters**

When solar converters are all installed prior to applying power and starting the system, the order in which the controller identifies the solar converters is by serial number (lowest serial number is Solar Conv 1, next lowest is Solar Conv 2, etc.). If you prefer the controller to identify the solar converters by position in the system, perform the following procedure.



**NOTE!** See also “Enabling Solar Mode” on page 32.

**Local Menu Navigation:**

None.

**Web Menu Navigation:**

See “Individual Solar Converter Settings Page” on page 113 and set the Solar Converter ID (repeat for every solar converter).  
then  
Settings Menu / Solar Converters Tab / Confirm Solar Converter ID.

**2.9.42 Configuring the Controller Identification of Converters**

When converters are all installed prior to applying power and starting the system, the order in which the controller identifies the converters is by serial number (lowest serial number is Conv 1, next lowest is Conv 2, etc.). If you prefer the controller to identify the converters by position in the system, perform the following procedure.

**Local Menu Navigation:**

None.

**Web Menu Navigation:**

See “Individual Converter Settings Page” on page 116 and set the Converter ID (repeat for every converter).  
then  
Settings Menu / “DC/DC” Converters Tab / Confirm Converter ID.

**2.9.43 Setting Digital Inputs**

**Local Menu Navigation:**

None.

**Web Menu Navigation:**

Advance Settings Menu / DI Alarms Tab

**2.9.44 Setting Battery Block and Battery Midpoint Monitoring (if equipped with an EIB Assembly)**

**Local Menu Navigation:**

None.

**Web Menu Navigation:**

Settings Menu / Battery Tab / and enter the following parameters.

**Parameters**

- EIB-# Voltage Type
- EIB-# Block In-Use Num
- EIB-# Block Voltage Diff or Block Voltage Diff (Mid)

**2.9.45 Setting External Shunts (connected to the EIB Assembly)**

**Local Menu Navigation:**

None.

**Web Menu Navigation:**

Advance Settings Menu / Shunts Tab / EIB-# / press “Modify/View” and enter the following parameters. When done, press “Set”.

**Parameters**

- Set As (Not Used, General, Load, Battery, Source)
- Signal Full Name

- Signal Abbr Name
- Full Scale Current
- Full Scale Voltage
- Break Value (Device Rating)
- High 1 Curr Limit Alarm (% of Breaker Value)
- High 1 Curr Alarm Severity
- High 1 Curr Alarm Relay
- High 2 Curr Limit Alarm (% of Breaker Value)
- High 2 Curr Alarm Severity
- High 2 Curr Alarm Relay

**WEB Menu Navigation (for shunts set as battery):**

See “Individual Battery Settings Page” on page 126.

**Parameters**

- EIB#Battery #, Rated Capacity

**2.9.46 Setting External Shunts (connected to the SMDU+ Assembly)**

**Local Menu Navigation:**

None.

**Web Menu Navigation:**

Advance Settings Menu / Shunts Tab / SMDUP # / press “Modify/View” and enter the following parameters. When done, press “Set”.

**Parameters**

- Set As (enabled, disabled)
- Signal Full Name
- Signal Abbr Name
- Full Scale Current
- Full Scale Voltage
- Break Value (Device Rating)
- High 1 Curr Limit Alarm (% of Breaker Value)
- High 1 Curr Alarm Severity
- High 1 Curr Alarm Relay
- High 2 Curr Limit Alarm (% of Breaker Value)
- High 2 Curr Alarm Severity
- High 2 Curr Alarm Relay

## 2.9.47 Setting Shunts (connected to the SMDU Assembly)

### **Local Menu Navigation:**

None.

### **Web Menu Navigation:**

Advance Settings Menu / Shunts Tab / SMDU # / press “Modify/View” and enter the following parameters. When done, press “Set”.

#### **Parameters**

- Set As (Not Used, General, Load, Battery, Source)
- Signal Full Name
- Signal Abbr Name
- Full Scale Current
- Full Scale Voltage
- Break Value (Device Rating)
- High 1 Curr Limit Alarm (% of Breaker Value)
- High 1 Curr Alarm Severity
- High 1 Curr Alarm Relay
- High 2 Curr Limit Alarm (% of Breaker Value)
- High 2 Curr Alarm Severity
- High 2 Curr Alarm Relay

### **WEB Menu Navigation (for shunts set as battery):**

Settings Menu / Quick Settings Tab / Signal Settings Section / SMDU#Batt# Rated Capacity and enter the following parameters.

#### **Parameters**

- SMDU#Batt#, Rated Capacity

## 2.9.48 Setting the SM-DUE Parameters (if furnished)

The SM-DUE is used to input external monitoring information to the controller. The SM-DUE provides the following monitoring inputs:

- Ten (10) input blocks with each providing the following monitoring inputs:
  - One (1) Load Bus Voltage (0 VDC to 60 VDC) per input block
  - One (1) Load Fuse Alarm (Bus- base of 0 VDC, >10 VDC alarm, <10 VDC normal) per input block
  - One (1) Programmable Analog Input, can be set to accept one (1) of the following inputs per input block:
    - 10 mV DC to 50 mV DC Load Shunt
    - General-Purpose Current Transducer
    - General-Purpose Voltage Transducer
    - 1 uA/K Temperature Sensor

Program these inputs per site requirements as detailed next.

## **Programming the SM-DUE Load Bus Voltage Input**

### **Local Menu Navigation:**

None.

### **Web Menu Navigation:**

Advance Settings Menu / Custom Inputs Tab / SMDUE # / Input Block #,  
press “Modify” and select “Enable” for the voltage input. When done, press “Set”.  
Close the window by clicking on the X button.

Go to the Advanced Settings Menu > Analogs Tab and set the voltage input parameters.

## **Programming the SM-DUE Load Fuse Alarm Input**

### **Local Menu Navigation:**

None.

### **Web Menu Navigation:**

Advance Settings Menu / Custom Inputs Tab / SMDUE # / Input Block #,  
press “Modify” and select “Enable” for the fuse alarm input. When done, press “Set”.  
Close the window by clicking on the X button.

Go to the Advanced Settings Menu > Fuses Tab and set the full and abbreviated name for this signal (if desired).

## **Programming the SM-DUE Analog Input Set as “10 mV DC to 50 mV DC Shunt”**



**NOTE!** Only load shunts are supported at this time.

### **Local Menu Navigation:**

None.

### **Web Menu Navigation:**

Advance Settings Menu / Custom Inputs Tab / SMDUE # / Input Block #,  
press “Modify” and select “Shunt” for the analog input. When done, press “Set”.  
Close the window by clicking on the X button.

Go to the Advanced Settings Menu > Shunts Tab and set the shunt parameters.

## **Programming the SM-DUE Analog Input Set as “General-Purpose Current Transducer”**

### **Local Menu Navigation:**

None.

### **Web Menu Navigation:**

Advance Settings Menu / Custom Inputs Tab / SMDUE # / Input Block #,  
press “Modify” and select “Transducer (0-20mA)” for the analog input. When done, press “Set”.  
Close the window by clicking on the X button.

Go to the Advanced Settings Menu > Analogs Tab and set the “Current Transducer#” parameters.

## **Programming the SM-DUE Analog Input Set as “General-Purpose Voltage Transducer”**

### **Local Menu Navigation:**

None.

**Web Menu Navigation:**

Advance Settings Menu / Custom Inputs Tab / SMDUE # / Input Block #,  
press “Modify” and select “Transducer (0-10V)” for the analog input. When done, press “Set”.  
Close the window by clicking on the X button.

Go to the Advanced Settings Menu > Analogs Tab and set the “Voltage Transducer#” parameters.

**Programming the SM-DUE Analog Input Set as “1 uA/K Temperature Sensor”**

**Local Menu Navigation:**

None.

**Web Menu Navigation:**

Advance Settings Menu / Custom Inputs Tab / SMDUE # / Input Block #,  
press “Modify” and select “Temperature” for the analog input. When done, press “Set”.  
Close the window by clicking on the X button.

Go to the Settings Menu > Temp Probes Tab and set the temp probe parameters.

## 2.9.49 Setting the System Current Alarm

**Local Menu Navigation:**

None.

**Web Menu Navigation:**

Settings Menu / System Tab / System Current Alarm (Enter a value in AMPS). If system current exceeds this value, a system current alarm is issued.

## 2.9.50 Setting the AC Generator Function

See also “**AC Generator Function:**” on page 138.

**Local Menu Navigation:**

None.

**Web Menu Navigation:**

Settings Menu / System Tab / AC Generator Function (select “Voltage” or “Battery Capacity”).

When “Voltage” selected: Enter parameters for “AC Generator Start Voltage”, “DI for AC Generator (optional)”, and “Site Has AC Utility Power (optional)”.

When “Battery Capacity” selected: Enter parameters for “AC GEN Start Batt Capacity”, “DI for AC Generator (optional)”, and “Site Has AC Utility Power (optional)”.

In the “Advance Settings Menu” under the “Alarms” tab, program a relay for the “Automatic AC Generator Run alarm” and “Manual AC Generator Run alarm”. The same relay must be selected for each of these alarms. This relay must not be assigned to any other alarm. This is the relay connected to the AC generator control signal. When the relay is energized (On), the generator is On. When the relay is de-energized (Off), the generator is Off.

## 2.9.51 Using the Relay Test Feature



**NOTE!** *The relay test can only be performed when no alarms are present.*

## Automatic Test

When placed in Relay Automatic Test Mode; all relays on an IB2 board, EIB board, and the controller de-energize (since Fail Safe is enabled, relay 1 on the 1st IB2 will be in alarm state, if wired for fail safe), then one-by-one each relay energizes for the time period selected and then de-energizes. Relay 1 will stay in the alarm state during the rest of the relay tests.

### **Local Menu Navigation:**

None.

### **Web Menu Navigation:**

Settings Menu / System Tab / set the Relay Test Time.

or

Advance Settings Menu / DO (Relay) Tab / set the Relay Test Time.

then

Settings Menu / System Tab / Relay Test (set to Automatic).

or

Advance Settings Menu / DO (Relay) Tab / Relay Test (set to Automatic).



**NOTE!** *The relay test can be exited at any time by setting the Relay Test to Disabled.*

## Manual Test

When placed in Relay Manual Test Mode, all relays on an IB2 board, EIB board, and controller de-energize (since Fail Safe is enabled relay 1 on the 1st IB2 will be in alarm state, if wired for fail safe). Then you can individually change each relay's state. The relay changes state for the time period selected. At the end of the test, all relays are returned to their normal state (if no alarms are present). This is the same procedure as "Manually Forcing Relays" on page 29 except you do not place the controller in Manual Mode.

### **Local Menu Navigation:**

None.

### **Web Menu Navigation:**

Settings Menu / System Tab / Relay Test (set to Manual).

or

Advance Settings Menu / DO (Relay) Tab / Relay Test (set to Manual).

then

Advance Settings Menu / DO (relay) / Relay (select the other state) then press the SET button.

then

Settings Menu / System Tab / Relay Test (set to Disabled).

or

Advance Settings Menu / DO (Relay) Tab / Relay Test (set to Disabled).

## 2.9.52 Clearing the Maintenance Alarm

A maintenance time can be set which, once expires, issues a maintenance alarm. When the maintenance alarm is issued, perform the routine maintenance and reset the maintenance timer. To reset the maintenance timer and clear the Maintenance Alarm, clear the Maintenance Run Time.

### **Local Menu Navigation:**

None.

### **Web Menu Navigation:**

Settings Menu / System Tab / “Auto/Manual” State (change to Manual).

then

Settings Menu / System Tab / Clear Maintenance Run Time.

then

Settings Menu / System Tab / “Auto/Manual” State (change to Auto).

## **2.9.53 Performing a Manual Battery Discharge Test**

### **Procedure**

1. Check that the Rated Battery Capacity is set up correctly for each battery.  
Local Menu: Main Menu / Settings / Batt 1 Setting and Batt2 Setting / Rated Capacity  
Web Menu: Settings Menu / Battery Test
2. Check that the following Battery Test parameters are set correctly: Test Voltage Level, End Test Voltage, End Test Time, End Test Capacity, Record Threshold.  
Local Menu: Main Menu / Settings / Batt Settings / Test Volt Level, End Test Volt, End Test Time, EndTestCapacity, RecordThreshold.  
Web Menu: Settings Menu / Battery Test / Battery Test Control.
3. Start the battery discharge test.  
Local Menu: Main Menu / Settings / Maintenance / BattTestControl.  
Web Menu: Settings Menu / Battery Test / Battery Test Control.
4. Wait for the test to end.
5. View the battery test log and upload it to your computer as required. See “Battery Test Log Tab” on page 156.

## **2.9.54 Updating the Controller’s Device Inventory**

### **Local Menu Navigation:**

Main Menu / Settings / Sys Settings / Auto Config.

### **Web Menu Navigation:**

Advance Settings Menu / SW Maintenance Tab / Auto Config.

## **2.9.55 Backing Up the Controller Configuration**

To back up the controller configuration, simply save the file named “SettingParam.tar”.



**NOTE!** *It is strongly recommended that you save a copy of the “SettingParam.tar” file whenever you make any changes to the controller. Then, if you ever replace the controller or perform a “Restore Defaults” procedure, you can restore your customized settings by downloading the previously saved “SettingParam.tar” file back into the controller.*

Prior to changing controller settings, ensure the current “SettingParam.tar” file is backed up. After making changes, create a new backup file.

To aid in file management, you may change the name of the “SettingParam.tar” file to differentiate it from other “SettingParam.tar” files saved. The new name can use alpha and numeric characters preceding the original “SettingParam.tar” name (the end of the new file name **must** always be “SettingParam.tar”; for example, an acceptable filename would be “seville4SettingParam.tar”).

### **Saving the “SettingParam.tar” File**

#### **Local Menu Navigation:**

None.



**Web Menu Navigation:**

Advance Settings Menu / SW Maintenance Tab.

See “Retrieve “SettingParam.tar” File Procedure” on page 184 to retrieve the “SettingParam.tar” file.

**2.9.56 Reloading a Backed-Up Controller Configuration**

To reload the controller configuration, simply download a saved “SettingParam.tar” file into the controller.

**Reloading the “SettingParam.tar” File****Local Menu Navigation:**

None.

**Web Menu Navigation:**

Advance Settings Menu / SW Maintenance Tab.

See “Upload/Download Procedure” on page 186 to download a “SettingParam.tar” file into the controller.

**2.9.57 Upgrading the Controller Using an Application (“All”) Package**

This procedure is typically used to upgrade your controller when a new release of firmware is available for your application. The name of the Application “All” Package file must end in .tar or .tar.gz. An Application “All” package file has both the application (software) and configuration settings file and is usually supplied for an application upgrade.

A User can copy an Application (“All”) Package from your computer to a USB memory device. You can then place the USB memory device into the controller USB port and then download the file into the controller. If upgrading the controller with a USB drive other than the supplied USB, the following USB drive specifications must be adhered to:

- USB 2.0 or below, 32G or less, formatted fat32 file system.

**Local Menu Navigation (To Download an Application (“All”) Package):**

1. Copy the file to a USB memory device. The file must be in the root directory of the USB memory device. The file must be named app\_v#.#.###.tar.gz.



**NOTE!** #.#.### is the revision number (i.e. 1.1.40, 4.1.40, etc.).

2. Connect the USB memory device to the USB port on the front of the controller.
3. Navigate to “Main Menu / Settings Icon / Sys Settings / Update App / select yes”. Once Yes is selected and confirmed, the configuration file located on the memory device located in the controller’s USB port is loaded into the controller.
4. A percent (%) complete will be displayed and when finished the controller will reboot automatically
5. The controller enters an initialization routine, which takes a few minutes. The routine is complete and the controller is operational when normal system voltage is displayed on the screen.
6. Remove the memory device.

**Web Menu Navigation (To Download an Application (“All”) Package):**

Advance Settings Menu / SW Maintenance Tab.

See “Upload/Download Procedure” on page 186 to download an Application (“All”) Package into the controller.

**2.9.58 Restoring Factory Default Configuration**

This procedure is used to restore all changes made to the controller to factory defaults.

**Procedure**

**ALERT!** When this procedure is performed, the controller's existing configuration and parameter settings will be lost. The "SettingParam.tar" file is deleted. Before restoring the factory default configuration, if you have made any changes to the controller, save the "SettingParam.tar" file (see Backing Up the Controller Configuration on page 42).

**Local Menu Navigation:**

Main Menu / Settings / Sys Settings / Reload Config.

**Web Menu Navigation:**

Advance Settings Menu / SW Maintenance Tab.

See "Restore Factory Default Configuration Procedure" on page 183.



**NOTE!** *SOME SYSTEMS REQUIRE CHANGES TO THE CONTROLLER CONFIGURATION DURING FINAL TEST BEFORE BEING SHIPPED.* These systems are supplied with a USB memory device that contains a "SettingParam.tar" file as shipped. If provided, the "SettingParam.tar" file has a seven-digit UIN (Unique Identification Number) preceding the "SettingParam.tar" filename. The UIN identifies a "SettingParam.tar" file for use with a specific system. This file can be used to restore your system to the configuration as shipped. Refer to "Reloading a Backed-Up Controller Configuration" on page 43 to reload the supplied "SettingParam.tar" file.

TO RESTORE THESE SYSTEMS TO THE CONTROLLER CONFIGURATION AS SHIPPED, RESTORE DEFAULTS AS DESCRIBED ABOVE; THEN RELOAD THE SUPPLIED "SETTINGPARAM.TAR" FILE.

**2.9.59 Rebooting the Controller**

**NOTE!** *The controller does not turn off any relay when the controller is reset/replaced. If the relay is active when the controller is reset/replaced, it will stay active whether or not the alarm condition still exists. If possible, the alarm condition should be cleared before the controller is reset/replaced. If the alarm is not cleared, after starting the controller, it may be necessary to manually trigger an alarm condition to clear all alarm relays.*

**Local Menu Navigation:**

At the MAIN SCREEN, press ENT and ESC at the same time to reset the controller.

**Web Menu Navigation:**

Advance Settings Menu / SW Maintenance Tab / Reboot Controller button.

**2.9.60 Changing the Names of Items Displayed in the LCD and Web-Interface Menus****Local Menu Navigation:**

none.

**Web Menu Navigation:**

Navigate to the appropriate tab in the Advance Settings menu. Press "Modify" and enter the signal name parameter(s). When done, press "Set".

**Digital Inputs**

Advance Settings Menu / DI Alarms Tab.

**Relay Outputs**

Advance Settings Menu / DO (relay) Tab.

**Shunts**

Advance Settings Menu / Shunts Tab.

## Fuses

Advance Settings Menu / Fuse Tab.

### 2.9.61 Upgrading the Rectifiers Firmware

Rectifier firmware upgrade files or USB memory device must be supplied to you. If provided rectifier firmware upgrade files, copy the files to a USB memory device. Place the USB memory device into the controller USB port and follow the procedure below. If upgrading rectifier firmware with a USB memory device other than a supplied USB memory device, the following USB memory device specifications must be adhered to:

- USB 2.0 or below, 32G or less, formatted fat32 file system.

#### Local Menu Navigation:

none.

#### Web Menu Navigation:

Settings Menu / Rectifier Tab / “Rectifier Upgrade” (change to Enabled).

then

Settings Menu / Rectifier Tab / “Normal Update” (change to Yes)

Go to the General Status Tab. See “General Status Tab” on page 130. As the rectifiers are programmed, the “Update OK Number” in the General Status Tab increments and the “Update State” gives you information about the rectifier that was being updated.

The screenshot displays the NetSure™ CONTROL UNIT web interface. The main content area shows the 'General Status' tab with a 'User Define' table. A red box highlights the 'Update OK Number' (0) and 'Update State' (None) entries. The right sidebar contains 'System Status' (System Voltage: 54.8V, System Current: 0.0A), 'System Specifications' (System Name: NCU, Product Model: M8300, Serial Number: 03160600725, Hardware Version: A09, Software Version: 1.2.01101, Config Version: ESNA\_Default), and 'Site Information' (Site Name: NCU, Site Location: Vertiv).

Signal	Value	Signal	Value
Update OK Number	0	Update State	None
Maintenance Run Time	78.3 h	Power Split Mode	Disabled
NCU DI1	Low	NCU DI2	Low
NCU DI3	Low	NCU DI4	Low
IB2-1 DI1	Low	IB2-1 DI2	Low
IB2-1 DI3	Low	IB2-1 DI4	Low
IB2-1 DI5	Low	IB2-1 DI6	Low
IB2-1 DI7	Low	IB2-1 DI8 ESTOP	Low
IB2-1 Temp1 (amb)	26.2 deg.C	IB2-1 Temp2 (bat)	26.2 deg.C

### 2.9.62 Upgrading the Inverters Firmware

Inverter firmware upgrade files or USB memory device must be supplied to you. If provided inverter firmware upgrade files, copy the files to a USB memory device. Place the USB memory device into the controller USB port and follow the procedure below. If upgrading inverter firmware with a USB memory device other than a supplied USB memory device, the following USB memory device specifications must be adhered to:

- USB 2.0 or below, 32G or less, formatted fat32 file system.

You can only upgrade one (1) inverter at a time. You cannot have multiple inverters running in the system while upgrading the inverter.

#### Local Menu Navigation:

None.

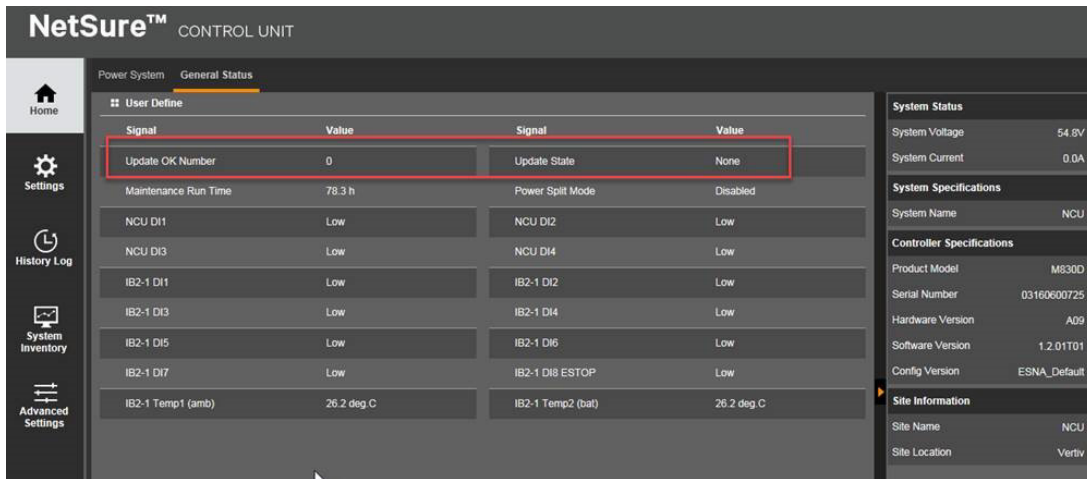
**Web Menu Navigation:**

Settings Menu / Inverter Tab / “Inverter Upgrade” (change to Enabled).

then

Settings Menu / Inverter Tab / “Normal Update” (change to Yes).

Go to the General Status Tab. See “General Status Tab” on page 130. As the inverters are programmed, the “Update OK Number” in the General Status Tab increments and the “Update State” gives you information about the inverter that was being updated.



## 2.10 Power Split Feature

In Power Split applications, the output of the power system controlled by the controller can be connected in parallel with an existing power system. Each system is controlled independently via its own controller. The controller power system is referred to as “System A” and the existing power system as “System B”. The Power Split feature controls the controller power system’s (“System A”) output voltage and rectifiers' current limit so that “System A” shares the load with “System B”.

Optional Functions: The controller can mimic the equalize and battery test functions of “System B’s” controller. In addition, the controller can mimic the low voltage load disconnect and/or low voltage battery disconnect functions of “System B”. This is accomplished by supplying digital signals from “System B’s” controller to the controller. This allows these functions to remain active in “System B”.

### 2.10.1 Overview

See also “Power Split Feature” on page 9.

#### How Power Split Works

There are four User adjustable parameters for Power Split. They are:

- **Power Split Current Limit Value:** Current limit point for power system designated as “System A” in a “Power Split” configuration.
- **Delta Voltage:** The offset voltage that the power system designated as “System A” in a “Power Split” configuration is set to. It is suggested to leave this value at the default (0.5 volts).
- **Proportion Coeff:** The proportional coefficient that the power system designated as “System A” in a “Power Split” configuration is set to. It is suggested to leave this value at the default (30%).
- **Integral Time:** The integral time that the power system designated as “System A” in a “Power Split” configuration is set to. It is suggested to leave this value at the default (60 seconds).

The controller uses these parameters to control the load sharing operation between the two power systems.

Depending on the systems' configurations, their rectifier capacities, their distribution load capacities, and the Power Split configuration; four operating modes can occur.

### **Low Load Operation**

When the total load current demand is lower than the Power Split Current Limit Value, the controller power system voltage will be increased by the programmed DELTA VOLTAGE setting forcing the controller power system to carry the load. Make sure that the output voltage does not exceed the battery float range recommended by the manufacturer. In this operating mode, no current will be delivered by the existing power system.

### **Normal Load Operation**

When the total load current demand reaches the Power Split Current Limit Value, the controller power system operates in output current limit and its output voltage will be decreased (up to the DELTA VOLTAGE setting) in order to regulate the current, allowing the existing power system to deliver the remaining current. Both the controller power system and the existing power system are now providing current to the load.

### **High Load Operation**

If current demand increases and the existing power system reaches its current limit setting, float voltage will again begin to decrease. When the voltage falls below the float setting minus the DELTA VOLTAGE setting, the controller system will come out of current limit and now deliver the additional current necessary to satisfy the load. This operation may occur when the batteries are being recharged, such as after a commercial AC failure.

### **Over Load Operation**

If the load current is greater than the combined current capacities of the controller system and the existing power system, both power systems will go into current limit. Both systems and the batteries will feed the load. The output voltage will depend on the conditions of the batteries. This operation occurs if the total capacity of the rectifiers is too low in relation to the need for increased current.

## **Operating Modes**

Figure 1.5 illustrates the four modes of operation described above.

The Normal Load Operation is considered to be the normal mode. In this mode both the controller system and the existing parallel power system are both delivering load current. This is main purpose of using Power Split, to avoid putting the burden of delivering the entire load onto one of the two power systems.

## **Requirements and Conditions**

The two DC power systems must be connected in parallel as described in "Paralleling the Existing and Mini Control Unit Power Systems" on page 48.

Before paralleling the two systems, the following conditions must be met for proper Power Split function.



**NOTE!** *The control features of the combined system are limited to those of the original power system.*



**NOTE!** *The same type of batteries with an equal amount of cells and the same charging voltages must be used for both systems.*

- The float voltage, equalize voltage, and battery test voltage of the controller power system must be set to the same levels as that of the existing power system.
- The remote sense, if available and connected, of both the controller power system and existing power system must be connected to the same point.
- If batteries are used, they must be of the same type.

- All the functions specific to the existing power system and controller power system and which depend on the voltage or which act on the voltage must be disabled from the existing power system and controller power system. This includes the following...
  - a) any equalization function,
  - b) any temperature compensation function,
  - c) any charge control function,
  - d) any battery discharge test function, and
  - e) any invalid current alarm.

In lieu of this, if battery charging and battery test functions are implemented in the existing power system, they can remain if signals for starting are connected from the control system of the existing system to the controller system.

## **Paralleling the Existing and Mini Control Unit Power Systems**

### **Important Safety Instructions**

#### General Safety



**DANGER!** YOU MUST FOLLOW APPROVED SAFETY PROCEDURES.

Performing the following procedures may expose you to hazards. These procedures should be performed by qualified technicians familiar with the hazards associated with this type of equipment. These hazards may include shock, energy, and/or burns. To avoid these hazards:

- a) The tasks should be performed in the order indicated.
- b) Remove watches, rings, and other metal objects.
- c) Prior to contacting any uninsulated surface or termination, use a voltmeter to verify that no voltage or the expected voltage is present. Check for voltage with both AC and DC voltmeters prior to making contact.
- d) Wear eye protection.
- e) Use certified and well maintained insulated tools. Use double insulated tools appropriately rated for the work to be performed.

#### AC Input Voltages



**DANGER!** This system operates from AC input voltage capable of producing fatal electrical shock.

#### DC Output and Battery Voltages



**DANGER!** Connecting the mini control unit power system to an existing power system for “Power Split” mode involves working on live equipment carrying live loads. This system produces DC Power and may have a battery source connected to it. Although the DC voltage is not hazardously high, the rectifiers and/or battery can deliver large amounts of current. Exercise extreme caution not to inadvertently contact or have any tool inadvertently contact an output terminal or battery terminal or exposed wire connected to an output terminal or battery terminal. NEVER allow a metal object, such as a tool, to contact more than one termination or battery terminal at a time, or to simultaneously contact a termination or battery terminal and a grounded object. Even a momentary short circuit can cause sparking, explosion, and injury. Remove watches, rings, or other jewelry before connecting leads. Cover any live busbars with a canvas sheet to prevent short circuits caused by falling tools or parts.

### **Preparing the Existing and Mini Control Unit Power Systems**

- Install and turn-up the Mini Control Unit power system as describe in the installation instructions furnished with the power system.
- Set the float voltage on both the existing and Mini Control Unit power systems to the same level. Temperature compensation functionality, if used, should be disabled on both power systems.

### **Paralleling the Systems**

- Connect the Battery and Battery Return busbars of the Mini Control Unit Power System to the main charge busbars (rectifier side of the shunt) on the parallel power system. Size the cable for the largest current between systems.

**Note 1:** *The connections between the two power systems should be done with power cables appropriately sized to be capable of carrying the maximum current that can circulate between the two power systems.*

**Note 2:** *If the parallel power system incorporates a main plant shunt, the connections of the cables from the Mini Control Unit power system to the parallel power system shall be made on the main charge busbars (rectifier side of the shunt).*

**Note 3:** *To compensate for voltage drop, it is recommended to connect the power system's remote sense leads (if available) to the same point of sensing as the parallel power system.*

**Note 4:** *There shall be only one battery return reference (BRR) cable for the two power systems. If the cable is appropriately sized on the parallel power system, keep it as the BRR for both power systems. If the cable is not appropriately sized on the parallel power system, install a new BRR cable and connect it preferably to the Mini Control Unit power system since the parallel power system may eventually be phased out.*

**Note 5:** *If battery disconnect units (BDUs) are used on the new or parallel power system, these shall be wired in such a way as to be all triggered simultaneously in order to prevent any overloading of these.*

**Note 6:** *For the size and number of bridge cables between the two power systems, take into consideration the voltage drop, the available connecting points in each system, as well as the fact that these cables are unfused and shall therefore be run on a dedicated cable rack. "C" or "H" taps may be used to make full use of available connecting points.*

**Note 7:** *The legacy system retains the function of its controller and the percent of load on each plant is controlled by the Mini Control Unit. Alarms may be sent individually from each plant, or combined using a Mini Control Unit Interface Board and the programmable relays resident in the controller.*

**Note 8:** *Add a label on both power systems to indicate that these are operating in the Power Split Mode with each other.*

- **Optional Function Connections:** The following signals from the existing system must be connected to digital inputs of the Mini Control Unit system interface board for these functions to be active: Equalize Charge in Progress, Battery Test in Progress, Load LVD Active, and Battery LVD Active. Otherwise disable these functions.

### **Programming the Mini Control Unit Power Split Feature**

After a Mini Control Unit power system has been connected to an existing power system and both systems set for the same float voltage, you will have to configure the Power Split parameters in the Mini Control Unit.

#### **Procedure**

1. In the Web Interface menus, set the Power Split mode to enabled. Navigate to Settings Menu / System / Power System / PowerSplit Mode. Set this parameter to "enabled".

2. Reboot the Mini Control Unit by pressing ESC and ENT at the same time.
3. Navigate to Settings Menu / System / Power System.
4. Set the “Power Split Current Limit Value” to a value that will force the Mini Control Unit system’s rectifiers to operate in current limiting mode.



**NOTE!** *The Power Split Current Limit Value must be set lower than the total distribution current from the two plants. The default value is 60% of the Mini Control Unit power system’s rectifier capacity.*

5. Set the “Delta Voltage”. This voltage is by default set to 0.5 V but can be readjusted.
  - If the distribution current is lower than 50% of the total capacity of the Mini Control Unit power system, the “Delta Voltage” can be adjusted to a lower level than 0.5 V to get a system voltage that is closer to the desired float charging voltage.
  - If the voltage drop between the existing system and the Mini Control Unit system is expected to be >0.5 V, the “Delta Voltage” can be adjusted to a higher level than 0.5 V to get a correct split function.
  - Temperature controlled battery charging cannot be set in the Mini Control Unit power system in power split mode. If this function is implemented in the existing power system, a limited function within a temperature range of approximately  $\pm 15$  °C will be achieved if the Delta Voltage is set to a higher level, maximum 2.00 V.
  - If the “Delta Voltage” 0.5 V is considered to be too high, the split function can be tested at various modes of operation to find a lower setting.

### **Optional Function Setup**

#### Equalize Charge Setup

If the equalize charge function is to be used, equalize charge must be implemented in the existing power system and an equalizing signal from its control unit must be connected to the Mini Control Unit.

1. In the Web Interface menus, navigate to Settings Menu / Battery / Equalize Charge Voltage. Set the “Equalize Charge Voltage” to the same value as the equalize voltage of the existing power system.
2. Using the Web Interface menus (see “Power Split Tab” on page 211), select the Mini Control Unit digital input connected to the existing systems equalize control circuit.



**NOTE!** *Equalize charging is controlled by the existing power system via an incoming digital signal. The system will remain at the set equalize charge voltage level as long as this signal is active.*

#### Battery Test Setup

If the battery test function is to be used, battery test must be implemented in the existing power system and a test signal from its control unit must be connected to the Mini Control Unit.

1. In the Web Interface menus, navigate to Settings Menu / Battery Test.
2. Set the “End Test Voltage” to the same value as the end voltage of the existing power system.
3. Set the “Test Voltage Level” to the same value as the test voltage of the existing power system.
4. Using the Web Interface menus (see “Power Split Tab” on page 211), select the Mini Control Unit digital input connected to the existing systems battery test control circuit.





**NOTE!** Other settings in this menu regarding “Battery Test” are inactive.



**NOTE!** Battery test is controlled by the existing power system via an incoming digital signal. The system will remain at battery test as long as this signal is active.

### Low Voltage Disconnect Setup

If low voltage disconnect functions are to be used, they must be implemented in the existing power system and signals from its control unit must be connected to the Mini Control Unit.

1. Using the Web Interface menus (see “Power Split Tab” on page 211), select the Mini Control Unit digital inputs connected to the low voltage disconnect control circuits.

### Temperature Compensated Battery Charge

There is no possibility to activate the “Temperature Compensated Battery Charge” function when the Mini Control Unit power system is configured for “Power Split” mode.

However, the possibility to change the “Delta Voltage” enables the Mini Control Unit power system to follow the existing power system that has the functionality to a certain limit.

Example: The “Delta Voltage” in the Mini Control Unit power system is set to 1.0V. The existing power system is set to compensate 3.0 mV/cell/°C. This means that the Mini Control Unit power system can follow the temperature compensation of the existing power system in the range of ±14 °C from the set normal battery temperature (3.0 mV x 24 cells x 14 °C = 1.008 V).

### **Verifying the Operation of the Power Split Feature**

After programming the “Power Split” feature, verify its operation as follows.

1. In a Power Split application where the Mini Control Unit power system is taking the entire load and the rectifiers in the existing power system are all in the standby mode, use an external dry load bank of sufficient capacity to increase the load on the Mini Control Unit power system over the “POWER SPLIT CURRENT LIMIT” value.
  - a) Verify that the Mini Control Unit power system limits the total output of its rectifiers to the current equivalent to this programmed percentage.
  - b) Verify that the Mini Control Unit power system lowers its output voltage by the value of the programmed “DELTA VOLTAGE”.
  - c) Verify that the rectifiers in the existing power system take the additional load as the load increases pass the “POWER SPLIT CURRENT LIMIT” value.
  - d) Further increase the load in order to exceed the total capacity of the rectifiers in the existing power system (or shut down some of the rectifiers in the existing power system if the capacity of the external dry load bank is not sufficient). Verify that the Mini Control Unit power system starts taking the additional load as soon as the total capacity of the rectifiers in the existing power system is exceeded.
2. In a Power Split application where the Mini Control Unit power system is taking only part of the load (operating continuously at the current level equivalent to the programmed “POWER SPLIT CURRENT LIMIT” percentage) and the rectifiers in the existing power system are taking the rest of the load, use an external dry load bank of sufficient capacity to increase the load in order to exceed the total capacity of the rectifiers in the existing power system (or shut down some of the rectifiers in the existing power system if the capacity of the external dry load bank is not sufficient).
  - a) Verify that the Mini Control Unit power system starts taking the additional load as soon as the total capacity of the rectifiers in the existing power system is exceeded.

## 2.11 FIAMM SoNick (Sodium Nickel) Batteries Interface

If a special configuration file is furnished, the controller has capability to receive status information sent from FIAMM SoNick (Sodium Nickel) batteries. Refer to the following for FIAMM SoNick (Sodium Nickel) battery interface notes.

### 2.11.1 FIAMM Battery Installation and User Instructions

The following instructions apply only when FIAMM 48TL200 batteries are used in a NetSure 721 Power System equipped with a controller FIAMM battery interface configuration.

#### Notes:

- Controller FIAMM battery configuration cannot be used with, or mixed with, batteries of other manufacturing types.
- A specific FIAMM controller configuration is required in order for the controller to actively display FIAMM battery monitoring parameters.

#### **Required FIAMM Documentation**

The following FIAMM instructional documentation is to be obtained directly from FIAMM.

Note that the following instructions were developed using the FIAMM documents and corresponding revision level as listed below.

- FIAMM Technical Manual, 'Installation & Operating Instructions\_48TL200\_12-2014'
- FIAMM Technical Bulletin, '48TL200 Modbus Protocol', (Revision 5, Issue Date 21/05/2012)
- FIAMM User Manual, '48TL200 SMC Monitor', (Revision 0, Issue Date 27/08/2012)
- FIAMM Technical Bulletin, 'SMC Battery Software Interface', (Revision 0.0, Issue Date 3-2014)

#### **FIAMM Battery SMCMonitor200 Software**

Installation and monitoring instructions of the FIAMM batteries using FIAMM SMCMonitor200. Software is located in the FIAMM Technical Bulletin, 'SMC Battery Software Interface', (Revision 0.0, Issue Date 3-2014). Contact FIAMM for any questions regarding the SMCMonitor200 operation.



**NOTE!** FIAMM SMCMonitor200 software is used exclusively to directly monitor FIAMM batteries via a User's computer. The monitoring software has no application with the controller.

Following software is required for SMCMonitor200 communication for the User's computer, and is available from FIAMM.

- Virtual Com-Port Driver Installation
- SMCMonitor200 1.5.3 Software Folder,
  - Containing Folders: Backup, Config, Log, XML
  - Containing Files: SMC Battery Software Interface\_So-Nick-48TL200.pdf; SMCMonitor200.exe

#### **Installation Requirements for Controller Monitoring of FIAMM Battery(s)**

The setup installation for monitoring of FIAMM batteries using the controller requires the following procedures.

1. Install RS485 conductors in parallel between the NetSure 721 and each of the FIAMM batteries.
2. Change the Modbus address on each of the FIAMM batteries.
3. Change the BAUD rate on each of the FIAMM battery controllers.

### **Install RS485 Conductors in Parallel Between the NetSure 721 and Each of the FIAMM Batteries**

In order for the controller to communicate with any FIAMM 48TL200 battery(s), each FIAMM 48TL200 battery must parallel connect its' respective RS485 (±) polarity terminal, between the NetSure 721 System Interface Circuit Card (P/N 556166) to the corresponding FIAMM's Com port.

Refer to the following documents for relative instructions:

- FIAMM Technical Manual, 'Installation & Operating Instructions\_48TL200\_12-2014'.
  - See: Sections 3.3, Battery Front Panel; Section 3.5 Data Cable Connector
- Vertiv, NetSure 721 Installation Manual (IM582127000).
- Vertiv, SD582127000, Schematic Diagram -48V Power System, (Issue J).
- Vertiv, T582127000, Wiring Diagram, Power System, (Issue AN).
- Vertiv, SD556166, Schematic Diagram for Interface, (Issue AA).

#### Procedure

1. Install one (1) 18 AWG conductor per polarity, parallel connecting between respective RS485 polarity terminals, located on the NetSure 721 System Interface Circuit Card (P/N 556166) and each of the FIAMM batteries.

### **Changing FIAMM Batteries ModBus Address**

FIAMM automatically assigns each battery with a default Modbus number of '02'. In order for the controller to communicate with multiple FIAMM 48TL200 batteries, each battery must have its respective address changed to one of the Modbus numbers noted below.

- Modbus Number Assignment
  - Regardless of which battery is chosen for the first Modbus assignment, assign the first battery with Modbus #6.
  - Assign any additional batteries using whole numbers only, up to #13.
  - Note only a maximum of (8) batteries can be monitored using the controller.



**NOTE!** Remember to STOP the SMC Monitor software communication before upgrading any software changes.

Refer to the following FIAMM documents for relative instructions:

- FIAMM Technical Bulletin, '48TL200 Modbus Protocol', (Revision 5, Issue Date 21/05/2012), Section "Setting a new MODBUS address".
- FIAMM User Manual, '48TL200 SMC Monitor', (Revision 0, Issue Date 27/08/2012), Section "FW Update".

#### Procedure

1. Change the Modbus Address of each of the FIAMM batteries by following instructions listed in the referenced FIAMM Document, '48TL200\_Modbus Protocol', Section 'Setting a new MODBUS address'.

### **Changing FIAMM Battery Controllers BAUD Rate**

In order for the controller to communicate with any FIAMM 48TL200 batteries, each FIAMM 48TL200 battery must have its respective BAUD rate changed to match the controller's BAUD rate of 9600.

As noted in FIAMM Technical Bulletin, '48TL200 Modbus Protocol', (Revision 5, Issue Date 21/05/2012), the default BAUD Rate is set in the FIAMM controller at 115.2k.

User is to upload the file, '48TL200-Baud-rate-9600.xml', into each FIAMM battery's separate controller, applying the respective software BAUD Rate adjustment to each 48TL200 battery using the upgrade utility instructions as described in the User Manual referenced below.

After the upload is complete, the User is to toggle the ON/Off switch located on each of the effected batteries, for purpose of applying the BAUD rate software changes to the controller.

Refer to the following FIAMM documents for relative instructions:

- FIAMM Technical Bulletin, '48TL200 Modbus Protocol', (Revision 5, Issue Date 21/05/2012), Section "Setting a new MODBUS address".
- FIAMM User Manual, '48TL200 SMC Monitor', (Revision 0, Issue Date 27/08/2012), Section "FW Update".

### Procedure

1. Change the BAUD rate on each of the FIAMM batteries by following the same "SMCMonitor200.exe" program instructions as noted for changing Modbus Address, described in the previous procedure, (referring again to the instructions listed in referenced FIAMM Document, '48TL200\_Modbus Protocol', Section 'Setting a new MODBUS address'). However, for the changing of the BAUD rate, a different operational '.xml' file is to be used.
  - Save the new BAUD rate in a .xml file as shown below, then load the file into each battery using the UTILITY-->UPGRADE function of the program:

```
<?xml version="1.0" ?>
- <NewParameter>
- <MCU>
- <NewParameters>
  <Parameter Name="MB Rate" Value="9600" />
</NewParameters>
</MCU>
</NewParameter>
```

## 2.12 TL1 Interface

TL1 is available as an orderable option.

### 2.12.1 General

The controller can operate as a Network Element (NE) in a Network Maintenance and Administration (NMA) system. NMA is software developed by Bell Communications Research (Bellcore) to run on an Operations System (OS). This system utilizes the Transaction Language 1 (TL1) command language.

It is beyond the scope of this manual to provide operational instructions for an NMA system and TL1 commands. Refer to the NMA system documentation and the appropriate Bellcore publications for operational instructions.

Specifically, refer to the current issue of the following Bellcore publications for further information on the NMA system and TL1 command language.

TR-NWT-000831  
 TR-NWT-000833  
 TR-NWT-000835  
 TR-NWT-000199  
 TA-NWT-000199  
 TA-NWT-000200  
 TA-NWT-001360



The URL address should include /data; otherwise, it is not processed by this feature. The URL address can contain /data? or /data/?.

The query (input parameters) in the request starts after the question mark (?).

There is an ampersand (&) between each field in the query.

The fields in the query can appear in any order.

The fields in the query are the starting time, the ending time, and 0 to 3 user keys. The starting time is assumed to be 4 hours before the current time if it is not specified. It can be up to 4 hours in the past. The ending time is assumed to be the current time if it is not specified. It can be up to 4 hours in the past.

The starting and ending time are specified in one of two ways. First, the time can be specified using “Unix timestamps”. The format is the number of seconds since Jan 01, 1970 UTC. For example, March 19, 2015 at 7:44UTC is 1426794290. The starting and ending time using the Unix timestamp format is specified using the field names stime and etime. The time is the local time on the controller.

The starting and ending time can also be specified using YYYY-MM-DD HH:MM:SS. Note that dashes (-) are used instead of slashes (/). The starting and ending time using this format is specified using field names starttime and endtime. The time is the local time on the controller.

The URL can include 0, 1, 2, or 3 user keys. These keys are ASCII text (A-Z, a-z, 0-9, '-', '\_', '~'), up to 16 characters in length. The keys are specified as ukey1, ukey2, and ukey3. The query can specify ukey3 without specifying ukey1 and ukey2.

The controller will respond to any abnormal request (two starting times, two ending times, ending time before starting time, unrecognized keywords, fields that are too long, etc.) with an error response.

## **Response**

The response to the HTTP request is provided as a CSV table. The CSV table starts with a header line. There is one line (row) for each of the data records.

Error responses are also returned in CSV format.

### **Response Title**

The header line contains the title for each field, enclosed in double quotes (") and separated by commas. This is the format of the title line:

```
"DateTime", "Epoch Time", "Status", "<title1>", "<title2>", "<titleN>", "UserKey1", "UserKey2", "UserKey3"
```

The **<title>** fields are the Full English Name of the samples in the table. There is one title for each signal which is sampled. The titles are enclosed in double quotes.

### **Response Data**

Each row is one line. Each line is separated by a CR/LF.

There is always at least one row in the response.

The fields in the response are DateTime, EpochTime, Status, Signal1...SignalN, Userkey1, Userkey2, Userkey3.

Fields are separated with commas. There is no space after each comma.

The **DateTime** field is the sample time specified using YYYY-MM-DD HH:MM:SS. The time is the local time on the controller. It is not enclosed in quotes.

The **Epoch Time** field is the sample time as the number of seconds since Jan 01, 1970 UTC. It is not enclosed in quotes.

The **Status** field is the return status of the request. The possible values for this field are listed below. These strings are enclosed in quotes.

“OK”

“No data in this time range.”

“The starting time and/or ending time is invalid.”

“The request is not understood.”

“Some requested signals are not available.”

The **UserKey** fields are the user keys, which were specified in the input request. The user keys are returned in every row in the response. They are always the last three columns in the response.

If a key is not present, then the data field in the output is empty. For example, if only ukey3 is specified, the output for the keys would be „<ukey3>. If no keys are specified, the output for the keys would be „

The rows in the response always include the same number of columns (that is, the same number of comma's). The number of columns (comma's) is the same whether the status is OK and data is provided or the status is not OK and no data is provided. If the status is not OK, the response will be like:

7/1/2014 19:07,1404241623,“No data in this time range”,,,,123,abc,foobar

### **Data Values**

The data values in the response are selected using the Data History in the controller. The signals that are returned in the response are selected in the configuration files and are cannot be changed directly by the user.

The display format specified in the signal's configuration is used to format the value in the response.

The sampling signal can be a virtual (calculated) signal.

The following data types are supported: LONG, FLOAT, UNSIGNED LOG. ENUMs are not supported. Signals which are not in one of these formats are not included in the header line or the data. These signals are skipped.

The data in the response contains one row for each minute between the starting and ending time specified in the request.

The Storing Interval can be different than 60 seconds.

The data value in a row is the data at or before the one minute interval for that row.

Example: System Voltage is sampled every 5 minutes. The samples are:

54.2V at 12:10.10

54.4V at 12:15.10

The data is request from 12:14 to 12:17. The data in the response would be:

12:14.00... 54.2...

12:15.00... 54.2...

12:16.00... 54.4...

12:17.00... 54.4...

### 2.13.3 EXAMPLE

The controller can be accessed at 192.168.1.2.

#### Request

http://192.168.1.2/data.cgi?stime=1404061200&etime=140464799 ukey1=123, ukey2=abc, ukey3=foobar

#### Response

"DateTime", "Epoch Time", "Temperature", "Supply Temp", "OAT Temp", "Temp Code", "UserKey1", "UserKey2", "UserKey3"

7/1/2014 19:07,1404241623,74.6,73.3,70.9,71.3,97,123,abc,foobar

7/1/2014 19:08,1404241723,75.6,74.3,71.9,72.3,97,123,abc,foobar

7/1/2014 19:10,1404241823,76.6,75.3,72.9,73.3,97,123,abc,foobar

## 2.14 Resolving Alarms

Table 2.3 lists the alarms that are shown in the Web Interface Advance Settings Menu under the Alarms Tab. These are also the possible alarms that display in the alarm screens on the local display and Web Interface. Table 2.3 also provides guidelines for fixing the condition that caused the alarm.



**NOTE!** These instructions describe the complete functionality of the controller. Some functionality is dependent on hardware connected to the controller. Some alarms listed may not display in your system or may be named differently. Refer to the controller Configuration Drawing (C-drawing) furnished with your system.

Refer also to the controller Configuration Drawing (C-drawing) furnished with your system for the factory default "Alarm Severity Level" settings and "Alarm Relay" mapping to the available alarms.

**Rectifier Lost Alarm Description:** The rectifier lost alarm occurs if the controller updates the inventory and finds that the number of rectifiers is different. Two conditions cause the controller to update its inventory. The first condition is if the controller reboots. Every time the controller starts up it updates the inventory. The second condition is when a rectifier is installed in the system. This causes the controller to update its inventory. When a rectifier is installed, the controller re-inventories which clears any "Rect Comm Fail" alarms. The controller then finds the inventory doesn't match what it used to and a "Rectifier Lost" alarm is activated.

**Table 2.4 Available Alarms**

**Table 2.3**

Alarm Name	Alarm Description	Action to Correct
<b>Power System Alarms</b>		
Supervision Unit Fail	Controller self-detection test fails.	Replace the controller.
CAN Communication Failure	CAN bus communications failure. No devices communicating on CAN bus.	Check communications cables.
Outgoing Alarms Blocked	Alarm relays are forced in the "off" state and alarms are blocked from changing the relay state.	Verify why controller setting was changed before changing back.
Maintenance Time Limit Alarm	Controller issues a maintenance alarm.	Perform routine maintenance and reset maintenance timer.
Config Error (Backup Config)	Configuration error 1.	Reload the "SettingParam.tar" file.
Config Error (Default Config)	Configuration error 2.	
Imbalance System Current	When a load shunt is furnished, the system load current measurement is imbalanced with internally calculated system load current. This is a check to see if the shunt reading is accurate and makes sense.	Check why current is imbalanced. Check what current is not being reported correctly (load, rectifier, battery, etc.).



**Table 2.3**

Alarm Name	Alarm Description	Action to Correct
Over Load	Output overload condition.	Check the load.
SPD	Surge protection device needs attention.	Check surge protection device.
EStop/EShutdown	System in emergency stop or emergency shutdown mode.	Check why the system was placed in this mode.
System Temp 1 Not Used	Temperature sensor port #1 is not used.	Temperature probe is enabled but not plugged in.
System Temp 2 Not Used	Temperature sensor port #2 is not used.	
System Temp 3 Not Used	Temperature sensor port #3 is not used.	
IB2-1 Temp 1 Not Used	Temperature sensor port #1 (on IB2-1 Board) is empty.	Temperature probe is enabled but not plugged in.
IB2-1 Temp 2 Not Used	Temperature sensor port #2 (on IB2-1 Board) is empty.	
IB2-2 Temp 1 Not Used	Temperature sensor port #1 (on IB2-2 Board) is empty.	
IB2-2 Temp 2 Not Used	Temperature sensor port #2 (on IB2-2 Board) is empty.	
EIB-1 Temp 1 Not Used	Temperature sensor port #1 (on EIB-1 Board) is empty.	
EIB-1 Temp 2 Not Used	Temperature sensor port #2 (on EIB-1 Board) is empty.	
EIB-2 Temp 1 Not Used	Temperature sensor port #1 (on EIB-2 Board) is empty.	
EIB-2 Temp 2 Not Used	Temperature sensor port #2 (on EIB-2 Board) is empty.	
System Temp 1 Sensor Fail	Temperature sensor #1 failure.	Replace temperature sensor.
System Temp 2 Sensor Fail	Temperature sensor #2 failure.	Note: The alarm "Temp Sensor Fail" will occur if the temperature probe fails internally or is not plugged in; however, this alarm will be suppressed if "Temp Not Used" alarm is active.
System Temp 3 Sensor Fail	Temperature sensor #3 failure.	
IB2-1 Temp 1 Sensor Fail	Temperature sensor #1 (connected to IB2-1 Board) failure.	
IB2-1 Temp 2 Sensor Fail	Temperature sensor #2 (connected to IB2-1 Board) failure.	Replace temperature sensor.  Note: The alarm "Temp Sensor Fail" will occur if the temperature probe fails internally or is not plugged in; however, this alarm will be suppressed if "Temp Not Used" alarm is active.
IB2-2 Temp 1 Sensor Fail	Temperature sensor #1 (connected to IB2-2 Board) failure.	
IB2-2 Temp 2 Sensor Fail	Temperature sensor #2 (connected to IB2-2 Board) failure.	
EIB-1 Temp 1 Sensor Fail	Temperature sensor #1 (connected to EIB-1 Board) failure.	
EIB-1 Temp 2 Sensor Fail	Temperature sensor #2 (connected to EIB-1 Board) failure.	
EIB-2 Temp 1 Sensor Fail	Temperature sensor #1 (connected to EIB-2 Board) failure.	
EIB-2 Temp 2 Sensor Fail	Temperature sensor #2 (connected to EIB-2 Board) failure.	
DHCP Failure	The DHCP function is enabled, but effective IP address cannot be acquired.	
PLC Config Error	PLC configuration error.	Re-enter the PLC logic functions.
485 Communication Failure	485 communications failure.	--
Minor Summary	Minor alarm summary (one or more alarms designated as minor is active).	Check additional alarms.

**Table 2.3**

Alarm Name	Alarm Description	Action to Correct
Major Summary	Major alarm summary (One or more alarms designated as major is active).	Check additional alarms.
Critical Summary	Critical alarm summary (One or more alarms designated as critical is active).	Check additional alarms.
Rectifier Group Lost	A rectifier group cannot be detected by the controller.	Check communications cables. Check additional alarms.
Over Voltage 1	Output voltage is higher than the Over Voltage 1 Alarm threshold.	Check why system voltage is high. Check the alarm setting.
Over Voltage 2	Output voltage is higher than the Over Voltage 2 Alarm threshold.	
Under Voltage 1	Output voltage is lower than the Under Voltage 1 Alarm threshold.	Check why system voltage is low. If there is a mains failure, check if some load could be switched off in order to prolong the operating time of the plant. If the system load is too high related to rectifier capacity, install additional rectifiers. If the batteries are being recharged, the alarm will cease by itself when battery voltage has increased to the charging level.
Under Voltage 2	Output voltage is lower than the Under Voltage 2 Alarm threshold.	
Over Voltage 1 (24V)	Output voltage is higher than the Over Voltage 1 Alarm threshold.	Check why system voltage is high. Check the alarm setting.
Over Voltage 2 (24V)	Output voltage is higher than the Over Voltage 2 Alarm threshold.	
Under Voltage 1 (24V)	Output voltage is lower than the Under Voltage 1 Alarm threshold.	Check why system voltage is low. If there is a mains failure, check if some load could be switched off in order to prolong the operating time of the plant. If the system load is too high related to rectifier capacity, install additional rectifiers. If the batteries are being recharged, the alarm will cease by itself when battery voltage has increased to the charging level.
Under Voltage 2 (24V)	Output voltage is lower than the Under Voltage 2 Alarm threshold.	
Diesel Run Over Temp	Diesel generator run over temperature alarm.	Check diesel generator.
DG1 is Running	Diesel generator 1 is running.	--
DG2 is Running	Diesel generator 2 is running.	--
Hybrid is High Load	Diesel generator high load alarm.	Check load on diesel generator.
DG1 Failure	Diesel generator 1 has failed.	Check diesel generator.
DG2 Failure	Diesel generator 2 has failed.	Check diesel generator.
Grid is on	AC is on grid.	--
Main Ambient Temp High1	Main Ambient Temperature High1 alarm.	Check why temperature is high or low.
Main Ambient Temp Low	Main Ambient Temperature Low alarm.	
Main Ambient Temp High2	Main Ambient Temperature High2 alarm.	
Main Ambient Sensor Fail	Main ambient temperature sensor failure.	Replace temperature sensor.
Relay Test	Relay Test in progress.	--

**Table 2.3**

Alarm Name	Alarm Description	Action to Correct
System Temp1 High 2	Temperature sensor #1 sensing temperature higher than high temperature threshold 2.	Check why temperature is high or low.
System Temp1 High 1	Temperature sensor #1 sensing temperature higher than high temperature threshold 1.	
System Temp1 Low	Temperature sensor #1 sensing temperature lower than low temperature threshold.	
System Temp2 High 2	Temperature sensor #2 sensing temperature higher than high temperature threshold 2.	
System Temp2 High 1	Temperature sensor #2 sensing temperature higher than high temperature threshold 1.	
System Temp2 Low	Temperature sensor #2 sensing temperature lower than low temperature threshold.	
System Temp3 High 2	Temperature sensor #3 sensing temperature higher than high temperature threshold 2.	
System Temp3 High 1	Temperature sensor #3 sensing temperature higher than high temperature threshold 1.	
System Temp3 Low	Temperature sensor #3 sensing temperature lower than low temperature threshold.	
IB2-1 Temp1 High 2	Temperature sensor #1 (connected to IB2-1 board and set as Ambient) sensing temperature higher than high temperature threshold 2.	Check why temperature is high or low.
IB2-1 Temp1 High 1	Temperature sensor #1 (connected to IB2-1 board and set as Ambient) sensing temperature higher than high temperature threshold 1.	
IB2-1 Temp1 Low	Temperature sensor #1 (connected to IB2-1 board and set as Ambient) sensing temperature lower than low temperature threshold.	
IB2-1 Temp2 High 2	Temperature sensor #2 (connected to IB2-1 board and set as Ambient) sensing temperature higher than high temperature threshold 2.	Check why temperature is high or low.
IB2-1 Temp2 High 1	Temperature sensor #2 (connected to IB2-1 board and set as Ambient) sensing temperature higher than high temperature threshold 1.	
IB2-1 Temp2 Low	Temperature sensor #2 (connected to IB2-1 board and set as Ambient) sensing temperature lower than low temperature threshold.	
IB2-2 Temp1 High 2	Temperature sensor #1 (connected to IB2-2 board and set as Ambient) sensing temperature higher than high temperature threshold 2.	Check why temperature is high or low.
IB2-2 Temp1 High 1	Temperature sensor #1 (connected to IB2-2 board and set as Ambient) sensing temperature higher than high temperature threshold 1.	
IB2-2 Temp1 Low	Temperature sensor #1 (connected to IB2-2 board and set as Ambient) sensing temperature lower than low temperature threshold.	
IB2-2 Temp2 High 2	Temperature sensor #2 (connected to IB2-2 board and set as Ambient) sensing temperature higher than high temperature threshold 2.	Check why temperature is high or low.
IB2-2 Temp2 High 1	Temperature sensor #2 (connected to IB2-2 board and set as Ambient) sensing temperature higher than high temperature threshold 1.	
IB2-2 Temp2 Low	Temperature sensor #2 (connected to IB2-2 board and set as Ambient) sensing temperature lower than low temperature threshold.	
EIB-1 Temp1 High 2	Temperature sensor #1 (connected to EIB-1 board and set as Ambient) sensing temperature higher than high temperature threshold 2.	Check why temperature is high or low.
EIB-1 Temp1 High 1	Temperature sensor #1 (connected to EIB-1 board and set as Ambient) sensing temperature higher than high temperature threshold 1.	
EIB-1 Temp1 Low	Temperature sensor #1 (connected to EIB-1 board and set as Ambient) sensing temperature lower than low temperature threshold.	

**Table 2.3**

Alarm Name	Alarm Description	Action to Correct
EIB-1 Temp2 High 2	Temperature sensor #2 (connected to EIB-1 board and set as Ambient) sensing temperature higher than high temperature threshold 2.	Check why temperature is high or low.
EIB-1 Temp2 High 1	Temperature sensor #2 (connected to EIB-1 board and set as Ambient) sensing temperature higher than high temperature threshold 1.	
EIB-1 Temp2 Low	Temperature sensor #2 (connected to EIB-1 board and set as Ambient) sensing temperature lower than low temperature threshold.	
EIB-2 Temp1 High 2	Temperature sensor #1 (connected to EIB-2 board and set as Ambient) sensing temperature higher than high temperature threshold 2.	Check why temperature is high or low.
EIB-2 Temp1 High 1	Temperature sensor #1 (connected to EIB-2 board and set as Ambient) sensing temperature higher than high temperature threshold 1.	
EIB-2 Temp1 Low	Temperature sensor #1 (connected to EIB-2 board and set as Ambient) sensing temperature lower than low temperature threshold.	
EIB-2 Temp2 High 2	Temperature sensor #2 (connected to EIB-2 board and set as Ambient) sensing temperature higher than high temperature threshold 2.	Check why temperature is high or low.
EIB-2 Temp2 High 1	Temperature sensor #2 (connected to EIB-2 board and set as Ambient) sensing temperature higher than high temperature threshold 1.	
EIB-2 Temp2 Low	Temperature sensor #2 (connected to EIB-2 board and set as Ambient) sensing temperature lower than low temperature threshold.	
SMTemp1 Temp1 High 2	Temperature sensor #1 (connected to SM-Temp 1 and set as Ambient) sensing temperature higher than high temperature threshold 2.	Check why temperature is high or low.
SMTemp1 Temp1 High 1	Temperature sensor #1 (connected to SM-Temp 1 and set as Ambient) sensing temperature higher than high temperature threshold 1.	
SMTemp1 Temp1 Low	Temperature sensor #1 (connected to SM-Temp 1 and set as Ambient) sensing temperature lower than low temperature threshold.	
...	...	...
SMTemp1 Temp8 High 2	Temperature sensor #8 (connected to SM-Temp 1 and set as Ambient) sensing temperature higher than high temperature threshold 2.	Check why temperature is high or low.
SMTemp1 Temp8 High 1	Temperature sensor #8 (connected to SM-Temp 1 and set as Ambient) sensing temperature higher than high temperature threshold 1.	
SMTemp1 Temp8 Low	Temperature sensor #8 (connected to SM-Temp 1 and set as Ambient) sensing temperature lower than low temperature threshold.	
...	...	...
SMTemp8 Temp1 High 2	Temperature sensor #1 (connected to SM-Temp 8 and set as Ambient) sensing temperature higher than high temperature threshold 2.	Check why temperature is high or low.
SMTemp8 Temp1 High 1	Temperature sensor #1 (connected to SM-Temp 8 and set as Ambient) sensing temperature higher than high temperature threshold 1.	
SMTemp8 Temp1 Low	Temperature sensor #1 (connected to SM-Temp 8 and set as Ambient) sensing temperature lower than low temperature threshold.	
...	...	...

**Table 2.3**

Alarm Name	Alarm Description	Action to Correct
SMTemp8 Temp8 High 2	Temperature sensor #8 (connected to SM-Temp 8 and set as Ambient) sensing temperature higher than high temperature threshold 2.	Check why temperature is high or low.
SMTemp8 Temp8 High 1	Temperature sensor #8 (connected to SM-Temp 8 and set as Ambient) sensing temperature higher than high temperature threshold 1.	
SMTemp8 Temp8 Low	Temperature sensor #8 (connected to SM-Temp 8 and set as Ambient) sensing temperature lower than low temperature threshold.	
High Load Level1	Load current above high level 1 setting.	Check why load current is high.
High Load Level2	Load current above high level 2 setting.	
DI1	Controller Digital input #1 alarm is active.	Check why alarm is active.
DI2	Controller Digital input #2 alarm is active.	
DI3	Controller Digital input #3 alarm is active.	
DI4	Controller Digital input #4 alarm is active.	
Controller DO1 Test	Testing Controller Relay DO1.	--
Controller DO2 Test	Testing Controller Relay DO2.	
Controller DO3 Test	Testing Controller Relay DO3.	
Controller DO4 Test	Testing Controller Relay DO4.	
Over Maximum Power Alarm	NOT IMPLEMENTED AT THIS TIME	NOT IMPLEMENTED AT THIS TIME
SMS Modem Fail	SMS modem has failed.	Check why SMS modem failed.
Manual State	Controller in manual state.	--
SNMP Config Error	SNMP configuration error.	--
Ambient Temp Summary Alarm	Ambient temperature alarm summary (one or more alarms designated as ambient temperature is active).	"Manufacturer Use" Only.
IB4 Communication Fail	Controller IB4 board communications failure.	Check communications cables.
Modbus Config Error	Modbus is configured incorrectly.	Correct Modbus configuration.
System Current Alarm	System current alarm active.	Check why system current alarm is active.
Automatic AC Generator Run	This alarm activates when the output voltage drops below the "AC Generator Start Voltage" if the AC generator function is set for "Voltage" mode or the battery capacity drops below the "AC GEN Start Batt Capacity" if the AC generator function is set for "Battery Capacity" mode. This alarm remains active until the "Auto EQ" cycle expires. When this alarm activates, the associated relay turns On to start the AC generator.	--
Manual AC Generator Run	This alarm activates when the "Manual AC Generator Run" setting is set to "Enabled". When this alarm activates, the associated relay turns On to start the AC generator.	--
EQ Time Out	This alarm momentarily activates if Auto EQ doesn't start within 5 minutes after the AC generator is told to start. When this alarm momentarily activates, it resets the "AC Generator" function.	See why Auto EQ failed to start.
AC GEN Start by Voltage	This alarm activates when the output voltage drops below the "AC Generator Start Voltage" if the AC generator function is set for "Voltage" mode and will deactivate when voltage raises above the threshold.	--
AC Gen Start by Batt Capacity	This alarm activates when the battery capacity drops below the "AC GEN Start Batt Capacity" if the AC generator function is set for "Battery Capacity" mode and will deactivate when battery capacity raises above the threshold.	--

**Table 2.3**

Alarm Name	Alarm Description	Action to Correct
AC Generator Fail	This alarm activates if “DI for AC Generator” is used, and the generator is being told to start but doesn’t.	See why generator failed to start.
Manual GEN 10min TimeOut	This alarm activates to indicate the specified time has timed out.	--
Manual GEN 1hr TimeOut		--
Manual GEN 8hr TimeOut		--
SMDUE1 Temp1 High 2	Temperature sensor #1 (connected to SM-DUE1 and set as Ambient) sensing temperature higher than high temperature threshold 2.	Check why temperature is high or low.
SMDUE1 Temp1 High 1	Temperature sensor #1 (connected to SM-DUE1 and set as Ambient) sensing temperature higher than high temperature threshold 1.	
SMDUE1 Temp1 Low	Temperature sensor #1 (connected to SM-DUE1 and set as Ambient) sensing temperature lower than low temperature threshold.	
...	...	...
SMDUE1 Temp10 High 2	Temperature sensor #10 (connected to SM-DUE1 and set as Ambient) sensing temperature higher than high temperature threshold 2.	Check why temperature is high or low.
SMDUE1 Temp10 High 1	Temperature sensor #10 (connected to SM-DUE1 and set as Ambient) sensing temperature higher than high temperature threshold 1.	
SMDUE1 Temp10 Low	Temperature sensor #10 (connected to SM-DUE1 and set as Ambient) sensing temperature lower than low temperature threshold.	
...	...	...
SMDUE8 Temp1 High 2	Temperature sensor #1 (connected to SM-DUE8 and set as Ambient) sensing temperature higher than high temperature threshold 2.	Check why temperature is high or low.
SMDUE8 Temp1 High 1	Temperature sensor #1 (connected to SM-DUE8 and set as Ambient) sensing temperature higher than high temperature threshold 1.	
SMDUE8 Temp1 Low	Temperature sensor #1 (connected to SM-DUE8 and set as Ambient) sensing temperature lower than low temperature threshold.	
...	...	...
SMDUE8 Temp10 High 2	Temperature sensor #10 (connected to SM-DUE8 and set as Ambient) sensing temperature higher than high temperature threshold 2.	Check why temperature is high or low.
SMDUE8 Temp10 High 1	Temperature sensor #10 (connected to SM-DUE8 and set as Ambient) sensing temperature higher than high temperature threshold 1.	
SMDUE8 Temp10 Low	Temperature sensor #10 (connected to SM-DUE8 and set as Ambient) sensing temperature lower than low temperature threshold.	
<b>Rectifier Group Alarms</b>		
Multiple Rectifiers Fail	More than one rectifier has failed or a Mains Failure.	Check input voltage to rectifiers. Replace rectifiers.
Rectifier Lost	A rectifier cannot be detected by the controller.	Reset the Rectifier Lost alarm. Replace defective rectifier.
ECO Active	Rectifier Energy Optimization Mode is enabled.	Check why system was placed into this mode.
All Rectifiers Comm Fail	No response from all rectifiers.	Check the connectors and cables or the CAN loop. Replace the controller.

**Table 2.3**

Alarm Name	Alarm Description	Action to Correct
ECO Cycle Alarm	If Energy Optimization Mode is enabled and the controller oscillates in and out of Energy Optimization more than 5 times, this alarm is generated.	Check for other alarms. Reset this alarm.
Rectifiers Limited(CAN1)	Alarms when rectifiers with different version software revisions are detected on CAN Bus 1.	--
Rectifiers Limited(CAN2)	Alarms when rectifiers with different version software revisions are detected on CAN Bus 2.	--
Load-share Problem(CAN1)	Alarms when the system consists of more than sixty (60) rectifiers and rectifiers with different version software revisions are detected on CAN Bus 1.	If this condition exists, there is a load share problem amongst the rectifiers. Suggest to replace the older version rectifiers with new versions.
Load-share Problem(CAN2)	Alarms when the system consists of more than sixty (60) rectifiers and rectifiers with different version software revisions are detected on CAN Bus 2.	If this condition exists, there is a load share problem amongst the rectifiers. Suggest to replace the older version rectifiers with new versions.
<b>Rectifier Alarms</b>		
AC Input Fail	No AC input power to a rectifier.	Check why no AC input power available.
Rect Temperature High	A rectifier has a high temperature condition.	Check why temperature is high.
Rectifier Fail	A rectifier has a fault condition.	Refer to Rectifier User Manual for troubleshooting information.
HVSD	A rectifier has an overvoltage condition.	
Rectifier Protected	A rectifier is in protected mode.	
Fan Fail	A rectifier's fan has failed.	Replace fan.
Power Limit	NOT IMPLEMENTED AT THIS TIME	NOT IMPLEMENTED AT THIS TIME
Rectifier Communication Fail	A rectifier has lost communications with the controller.	Check communications cables. Reset the Communication Fail alarm. Replace the rectifier.
Derated	A rectifier is in output power derating mode.	Refer to Rectifier User Manual for troubleshooting information.
Current Share Alarm	A rectifier has a current sharing alarm.	
AC Under Voltage Protection (Three Phase Rectifier's Only)	A rectifier is in under voltage protection mode. Example: When the rectifier's AC voltage is between a predefined AC value (see Rectifier User's Manual) and the rectifier's power draw is greater than a predefined power level (see Rectifier's User's Manual), you will get the alarm "AC Under Voltage Protection".	
Rectifier Summary Alarm	Rectifier alarm summary (one or more alarms designated as rectifier is active).	"Manufacturer Use" Only.
<b>Rectifier Group 2 [3, 4] Alarms</b>		
All Rectifiers Comm Fail	No response from all rectifiers.	Check the connectors and cables or the CAN loop. Replace the controller.
Rectifier Lost	A rectifier cannot be detected by the controller.	Reset the Rectifier Lost alarm. Replace defective rectifier.
Communication Failure	A rectifier has lost communications with the controller.	Reset the Comm Fail alarm. Replace defective rectifier.
Mains Failure	Rectifier commercial AC input power failure.	--
Multiple Rectifiers Fail	More than one rectifier has failed or a Mains Failure.	Check input voltage to rectifiers. Replace rectifiers.
<b>Group I [II, III] Rectifier Alarms</b>		
AC Input Failure	No AC input power to a rectifier.	Check why no AC input power available.
Rectifier HighTemperature	A rectifier has a high temperature condition.	Check why temperature is high.
Rectifier Fault	A rectifier has a fault condition.	Refer to Rectifier User Manual for troubleshooting information.
Overvoltage	A rectifier has an over voltage condition.	
Rectifier Protected	A rectifier is in protected mode.	

**Table 2.3**

Alarm Name	Alarm Description	Action to Correct
Fan Failure	A rectifier's fan has failed.	Replace fan.
Power Limit	NOT IMPLEMENTED AT THIS TIME	NOT IMPLEMENTED AT THIS TIME
Rectifier Communication Fail	A rectifier has lost communications with the controller.	Check communications cables. Reset the Communication Fail alarm. Replace the rectifier.
Derated	A rectifier is in output power derating mode.	Refer to Rectifier User Manual for troubleshooting information.
Current Sharing Alarm	A rectifier has a current sharing alarm.	
AC Undervoltage Protection	A rectifier is in under voltage protection mode.	
<b>Solar Converter Group Alarms</b>		
Multiple Solar Converter Failure	More than one solar converter has failed.	Check input voltage to solar converters. Replace solar converters.
Solar Converter Lost	A solar converter cannot be detected by the controller.	Reset the Solar Converter Lost alarm. Replace defective solar converter.
All Solar Converters Comm Fail	No response from all solar converters for a time duration of 73 hours.	Check the connectors and cables or the CAN loop. Check the DC input to the solar converters. Replace the controller.
<b>Solar Converter Alarms</b>		
Input Failure	No input power to a solar converter.	Check why no input power available.
Solar Converter Temperature High	A solar converter has a high temperature condition.	Check why temperature is high.
Solar Converter Fail	A solar converter has a fault condition.	Refer to Solar Converter User Manual for troubleshooting information.
Over Voltage	A solar converter has an overvoltage condition.	
Solar Converter Protected	A solar converter is in protected mode.	
Fan Fail	A solar converter's fan has failed.	Replace fan.
Current Limit	A solar converter is in current limit.	Solar converter overload. The load is higher than solar converter capacity. If one or more of the solar converters are defective, replace the faulty solar converters.
Solar Converter Comm Fail	A solar converter has lost communications with the controller.	Check communications cables. Reset the Solar Converter Communication Fail alarm. Replace the solar converter.
Derated	A solar converter is in output power derating mode.	Refer to Solar Converter User Manual for troubleshooting information.
Current Share Alarm	A solar converter has a current sharing alarm.	
Input Under Voltage Protection	A solar converter is in under voltage protection mode.	
Input Not DC	Input to solar converter mounting position is not DC.	--
<b>Battery Group Alarms</b>		
Short Battery Test Running	Battery is in short time test mode.	--
Equalize for Test	Battery is in equalize charge test mode.	--
Manual Test	Battery is in manual battery discharge test mode.	--
Planned Test	Battery is in planned battery test mode.	--
AC Fail Test	AC power has been switched off to the rectifiers to perform a battery discharge test.	--
Manual Equalize	Battery is in manual equalize charging mode.	--
Automatic Equalize	Battery is in automatic equalize charging mode.	--



**Table 2.3**

Alarm Name	Alarm Description	Action to Correct
Cyclic Equalize	Battery is in cyclic equalize charging mode.	--
Power Split Equalize	In Power Split mode, "System A" starts equalize charging with the "System B".	--
Power Split Battery Test	In Power Split mode, "System A" starts the test with the "System B".	--
Discharge Current Imbalance	Battery distribution current imbalance alarm.	The currents from two groups of batteries are not equal. Check the batteries.
Abnormal Battery Current	The equalize charging current exceeds the alarm setting.	Check the alarm setting.
Temperature Compensation Active	Battery charge temperature compensation is active.	--
Battery Current Limit Active	Battery is in current limit.	--
Bad Battery	Battery test fails.	Check the batteries.
Battery Discharge	Battery is discharging.	A battery test is active (the discharge test will stop automatically). There is a mains failure (check that it is not caused by open AC input circuit breaker). The system load is higher than rectifier capacity, causing the batteries to discharge (install additional rectifiers).
Battery Test Fail	Battery test fails.	Check the batteries.
Comp Temp High2	Compensation temperature sensor sensing temperature higher than high temperature threshold 2.	Check why temperature is high or low.
Comp Temp High1	Compensation temperature sensor sensing temperature higher than high temperature threshold 1.	
Comp Temp Low	Compensation temperature sensor sensing temperature lower than low temperature threshold.	
Compensation Sensor Fault	Temperature Compensation temperature sensor failure.	Replace temperature sensor.
System Temp1 High 2	Temperature sensor #1 sensing temperature higher than high temperature threshold 2.	Check why temperature is high or low.
System Temp1 High 1	Temperature sensor #1 sensing temperature higher than high temperature threshold 1.	
System Temp1 Low	Temperature sensor #1 sensing temperature lower than low temperature threshold.	
System Temp2 High 2	Temperature sensor #2 sensing temperature higher than high temperature threshold 2.	Check why temperature is high or low.
System Temp2 High 1	Temperature sensor #2 sensing temperature higher than high temperature threshold 1.	
System Temp2 Low	Temperature sensor #2 sensing temperature lower than low temperature threshold.	
System Temp3 High 2	Temperature sensor #3 sensing temperature higher than high temperature threshold 2.	Check why temperature is high or low.
System Temp3 High 1	Temperature sensor #3 sensing temperature higher than high temperature threshold 1.	
System Temp3 Low	Temperature sensor #3 sensing temperature lower than low temperature threshold.	
IB2-1 Temp1 High 2	Temperature sensor #1 (connected to IB2-1 board and set as Battery) sensing temperature higher than high temperature threshold 2.	Check why temperature is high or low.
IB2-1 Temp1 High 1	Temperature sensor #1 (connected to IB2-1 board and set as Battery) sensing temperature higher than high temperature threshold 1.	
IB2-1 Temp1 Low	Temperature sensor #1 (connected to IB2-1 board and set as Battery) sensing temperature lower than low temperature threshold.	

**Table 2.3**

Alarm Name	Alarm Description	Action to Correct
IB2-1 Temp2 High 2	Temperature sensor #2 (connected to IB2-1 board and set as Battery) sensing temperature higher than high temperature threshold 2.	Check why temperature is high or low.
IB2-1 Temp2 High 1	Temperature sensor #2 (connected to IB2-1 board and set as Battery) sensing temperature higher than high temperature threshold 1.	
IB2-1 Temp2 Low	Temperature sensor #2 (connected to IB2-2 board and set as Battery) sensing temperature lower than low temperature threshold.	
IB2-2 Temp1 High 2	Temperature sensor #1 (connected to IB2-2 board and set as Battery) sensing temperature higher than high temperature threshold 2.	Check why temperature is high or low.
IB2-2 Temp1 High 1	Temperature sensor #1 (connected to IB2-2 board and set as Battery) sensing temperature higher than high temperature threshold 1.	
IB2-2 Temp1 Low	Temperature sensor #1 (connected to IB2-2 board and set as Battery) sensing temperature lower than low temperature threshold.	
IB2-2 Temp2 High 2	Temperature sensor #2 (connected to IB2-2 board and set as Battery) sensing temperature higher than high temperature threshold 2.	Check why temperature is high or low.
IB2-2 Temp2 High 1	Temperature sensor #2 (connected to IB2-2 board and set as Battery) sensing temperature higher than high temperature threshold 1.	
IB2-2 Temp2 Low	Temperature sensor #2 (connected to IB2-2 board and set as Battery) sensing temperature lower than low temperature threshold.	
EIB-1 Temp1 High 2	Temperature sensor #1 (connected to EIB-1 board and set as Battery) sensing temperature higher than high temperature threshold 2.	Check why temperature is high or low.
EIB-1 Temp1 High 1	Temperature sensor #1 (connected to EIB-1 board and set as Battery) sensing temperature higher than high temperature threshold 1.	
EIB-1 Temp1 Low	Temperature sensor #1 (connected to EIB-1 board and set as Battery) sensing temperature lower than low temperature threshold.	
EIB-1 Temp2 High 2	Temperature sensor #2 (connected to EIB-1 board and set as Battery) sensing temperature higher than high temperature threshold 2.	Check why temperature is high or low.
EIB-1 Temp2 High 1	Temperature sensor #2 (connected to EIB-1 board and set as Battery) sensing temperature higher than high temperature threshold 1.	
EIB-1 Temp2 Low	Temperature sensor #2 (connected to EIB-1 board and set as Battery) sensing temperature lower than low temperature threshold.	
EIB-2 Temp1 High 2	Temperature sensor #1 (connected to EIB-2 board and set as Battery) sensing temperature higher than high temperature threshold 2.	Check why temperature is high or low.
EIB-2 Temp1 High 1	Temperature sensor #1 (connected to EIB-2 board and set as Battery) sensing temperature higher than high temperature threshold 1.	
EIB-2 Temp1 Low	Temperature sensor #1 (connected to EIB-2 board and set as Battery) sensing temperature lower than low temperature threshold.	
EIB-2 Temp2 High 2	Temperature sensor #2 (connected to EIB-2 board and set as Battery) sensing temperature higher than high temperature threshold 2.	Check why temperature is high or low.
EIB-2 Temp2 High 1	Temperature sensor #2 (connected to EIB-2 board and set as Battery) sensing temperature higher than high temperature threshold 1.	
EIB-2 Temp2 Low	Temperature sensor #2 (connected to EIB-2 board and set as Battery) sensing temperature lower than low temperature threshold.	

**Table 2.3**

Alarm Name	Alarm Description	Action to Correct
SMTemp1 Temp1 High 2	Temperature sensor #1 (connected to SM-Temp 1 and set as Battery) sensing temperature higher than high temperature threshold 2.	Check why temperature is high or low.
SMTemp1 Temp1 High 1	Temperature sensor #1 (connected to SM-Temp 1 and set as Battery) sensing temperature higher than high temperature threshold 1.	
SMTemp1 Temp1 Low	Temperature sensor #1 (connected to SM-Temp 1 and set as Battery) sensing temperature lower than low temperature threshold.	
...	...	...
SMTemp1 Temp8 High 2	Temperature sensor #8 (connected to SM-Temp 1 and set as Battery) sensing temperature higher than high temperature threshold 2.	Check why temperature is high or low.
SMTemp1 Temp8 High 1	Temperature sensor #8 (connected to SM-Temp 1 and set as Battery) sensing temperature higher than high temperature threshold 1.	
SMTemp1 Temp8 Low	Temperature sensor #8 (connected to SM-Temp 1 and set as Battery) sensing temperature lower than low temperature threshold.	
...	...	...
SMTemp8 Temp1 High 2	Temperature sensor #1 (connected to SM-Temp 8 and set as Battery) sensing temperature higher than high temperature threshold 2.	Check why temperature is high or low.
SMTemp8 Temp1 High 1	Temperature sensor #1 (connected to SM-Temp 8 and set as Battery) sensing temperature higher than high temperature threshold 1.	
SMTemp8 Temp1 Low	Temperature sensor #1 (connected to SM-Temp 8 and set as Battery) sensing temperature lower than low temperature threshold.	
...	...	...
SMTemp8 Temp8 High 2	Temperature sensor #8 (connected to SM-Temp 8 and set as Battery) sensing temperature higher than high temperature threshold 2.	Check why temperature is high or low.
SMTemp8 Temp8 High 1	Temperature sensor #8 (connected to SM-Temp 8 and set as Battery) sensing temperature higher than high temperature threshold 1.	
SMTemp8 Temp8 Low	Temperature sensor #8 (connected to SM-Temp 8 and set as Battery) sensing temperature lower than low temperature threshold.	
BTRM Temp High 2	Battery temperature (monitored by the sensor set as BTRM) is higher than the BTRM Temperature Alarm 2 threshold.	Check why temperature is high or low.
BTRM Temp High 1	Battery temperature (monitored by the sensor set as BTRM) is higher than the BTRM Temperature Alarm 1 threshold.	
BTRM Sensor Fail	BTRM temperature sensor failure.	Replace temperature sensor.
Inventory Update In Process	Only available if controller configuration includes the Li-Ion battery interface. Li-Ion Battery inventory being updated.	--
ABCL is active	Only available if controller configuration includes the Li-Ion battery interface. Active Battery Charge Current Limit is active.	--
Battery Charge Prohibited Alarm	Only available if controller configuration includes the Li-Ion battery interface. A battery charge prohibited alarm is active.	See why alarm is active.

**Table 2.3**

Alarm Name	Alarm Description	Action to Correct
Battery Temp Summary Alarm	Battery temperature alarm summary (one or more alarms designated as battery temperature is active).	"Manufacturer Use" Only.
SMDUE1 Temp1 High 2	Temperature sensor #1 (connected to SM-DUE1 and set as Battery) sensing temperature higher than high temperature threshold 2.	Check why temperature is high or low.
SMDUE1 Temp1 High 1	Temperature sensor #1 (connected to SM-DUE1 and set as Battery) sensing temperature higher than high temperature threshold 1.	
SMDUE1 Temp1 Low	Temperature sensor #1 (connected to SM-DUE1 and set as Battery) sensing temperature lower than low temperature threshold.	
...	...	...
SMDUE1 Temp10 High 2	Temperature sensor #10 (connected to SM-DUE1 and set as Battery) sensing temperature higher than high temperature threshold 2.	Check why temperature is high or low.
SMDUE1 Temp10 High 1	Temperature sensor #10 (connected to SM-DUE1 and set as Battery) sensing temperature higher than high temperature threshold 1.	
SMDUE1 Temp10 Low	Temperature sensor #10 (connected to SM-DUE1 and set as Battery) sensing temperature lower than low temperature threshold.	
...	...	...
SMDUE8 Temp1 High 2	Temperature sensor #1 (connected to SM-DUE8 and set as Battery) sensing temperature higher than high temperature threshold 2.	Check why temperature is high or low.
SMDUE8 Temp1 High 1	Temperature sensor #1 (connected to SM-DUE8 and set as Battery) sensing temperature higher than high temperature threshold 1.	
SMDUE8 Temp1 Low	Temperature sensor #1 (connected to SM-DUE8 and set as Battery) sensing temperature lower than low temperature threshold.	
...	...	...
SMDUE8 Temp10 High 2	Temperature sensor #10 (connected to SM-DUE8 and set as Battery) sensing temperature higher than high temperature threshold 2.	Check why temperature is high or low.
SMDUE8 Temp10 High 1	Temperature sensor #10 (connected to SM-DUE8 and set as Battery) sensing temperature higher than high temperature threshold 1.	
SMDUE8 Temp10 Low	Temperature sensor #10 (connected to SM-DUE8 and set as Battery) sensing temperature lower than low temperature threshold.	
BTRM Temp Delta	Activates for the condition selected in the "BTRM Temp Delta Alarm" parameter. Refer to "Battery Tab Programmable Parameter Descriptions" on page 140 for details.	--
<b>Battery 1 Alarms</b>		
Battery Current Limit Exceeded	Battery current limit point is exceeded.	--
Battery Over Current	Battery is in over current.	--
Low Battery Capacity	Battery has low capacity.	Check the batteries.
Battery Current High 1 Curr	Current above High 1 limit.	Check why current is high.
Battery Current High 2 Curr	Current above High 2 limit.	

**Table 2.3**

Alarm Name	Alarm Description	Action to Correct
<b>Battery Fuse Alarms</b>		
Fuse 1 Alarm	Fuse #1 is open.	Find out and eliminate the reason the fuse is open before replacing. Check for overload or short circuit. If the fuse was manually removed, check with the person that removed it before reinserting it.
...	...	
Fuse 6 Alarm	Fuse #6 is open.	
<b>SMDU Battery Fuse Unit Alarms (SMDU Module must be present in system)</b>		
Batt Fuse 1 Alarm	Battery fuse #1 is open.	Find out and eliminate the reason the fuse is open before replacing. Check for overload or short circuit. If the fuse was manually removed, check with the person that removed it before reinserting it.
...	...	
Batt Fuse 6 Alarm	Battery fuse #4 is open.	
<b>SMDU Battery Alarms (SMDU Module must be present in system)</b>		
Exceed Current Limit	Battery current limit point is exceeded.	--
Over Battery Current	Battery is in over current.	--
Low Capacity	Battery has low capacity.	Check the batteries.
<b>SM Battery Alarms (SM-BAT Module must be present in system)</b>		
Current Limit Exceeded	Battery is in over current.	--
Over Battery Current	Battery current is high.	--
Battery Leakage	Battery has leakage current.	Check the batteries.
Low Acid Level	Battery has low acid level.	Check the batteries.
Battery Disconnected	Battery disconnection is active.	--
High Battery Temperature	Battery has high temperature condition.	--
Low Battery Temperature	Battery has low temperature condition.	--
Cell Voltage Difference	Battery cell voltage difference detected.	Check the batteries.
SM-BAT Unit Failure	Battery monitoring device has failed.	Replace device.
Battery Temperature Sensor Failure	Battery temperature sensor has failed.	Replace temperature sensor.
Low Capacity	Battery has low capacity.	Check the batteries.
Battery Not Responding	Battery monitoring device has lost communications with the controller.	Check communications cables.
Temperature Sensor not Used	No battery temperature sensor.	--
<b>DC Distribution Alarms</b>		
Current High 1 Curr	Current above High 1 limit.	Check why current is high.
Current High 2 Curr	Current above High 2 limit.	
<b>DC Fuse Unit Alarms</b>		
Fuse 1 Alarm	DC output fuse #1 is open.	Find out and eliminate the reason the fuse is open before replacing. Check for overload or short circuit. If the fuse was manually removed, check with the person that removed it before reinserting it.
...	...	
Fuse 12 Alarm	DC output fuse #12 is open.	
<b>SMDU DC Fuse Alarms (SMDU Module must be present in system)</b>		
Fuse 1 Alarm	DC output fuse #1 is open.	Find out and eliminate the reason the fuse is open before replacing. Check for overload or short circuit. If the fuse was manually removed, check with the person that removed it before reinserting it.
...	...	
Fuse 16 Alarm	DC output fuse #16 is open.	

**Table 2.3**

Alarm Name	Alarm Description	Action to Correct
<b>SMDUP1 [2, 3, 4, 5, 6, 7, 8] DC Fuse Alarms (SMDU+ Module must be present in system)</b>		
Fuse 1 Alarm	DC output fuse #1 is open.	Find out and eliminate the reason the fuse is open before replacing. Check for overload or short circuit. If the fuse was manually removed, check with the person that removed it before reinserting it.
...	...	
Fuse 25 Alarm	DC output fuse #25 is open.	
<b>LVD Unit Alarms (Low voltage disconnect must be present in system)</b>		
LVD 1 Disconnect	LVD1 contactor is in disconnect mode.	--
LVD 2 Disconnect	LVD2 contactor is in disconnect mode.	--
LVD 1 Fail	LVD1 contactor has failed.	Check the contactor functions. Replace the contactor.
LVD 2 Fail	LVD2 contactor has failed.	
<b>LVD3 Unit Alarms</b>		
LVD 3 Disconnect	LVD3 contactor is in disconnect mode.	--
LVD 3 Fail	LVD3 contactor has failed.	Check the contactor functions. Replace the contactor.
<b>SMDU LVD Alarms (SMDU Module must be present in system)</b>		
LVD 1 Disconnect	LVD1 contactor is in disconnect mode.	--
LVD 2 Disconnect	LVD2 contactor is in disconnect mode.	--
LVD 1 Contactor Fail	LVD1 contactor has failed.	Check the contactor functions. Replace the contactor.
LVD 2 Contactor Fail	LVD2 contactor has failed.	
<b>Rectifier AC Alarms</b>		
<p>Note: Settings for AC Over Voltage 1 and 2 and AC Under Voltage 1 and 2 for each AC1, AC2, and AC3 are set under Mains Failure Alarm Limit 1 and 2.</p> <p>Example:</p> <p>Nominal AC Voltage: 220 VAC</p> <p>Mains Failure Alarm Limit 1: 20%</p> <p>Mains Failure Alarm Limit 2: 25%</p> <p>Then,</p> <p>AC Over Voltage 1 will occur at <math>220 + (220 \times 0.2) = 264</math> VAC</p> <p>AC Over Voltage 2 will occur at <math>220 + (220 \times 0.25) = 275</math> VAC</p> <p>AC Under Voltage 1 will occur at <math>220 - (220 \times 0.2) = 176</math> VAC</p> <p>AC Under Voltage 2 will occur at <math>220 - (220 \times 0.25) = 165</math> VAC</p>		
AC1 Over Voltage 1	AC1 voltage is above over voltage 1 threshold.	Check why voltage is high.
AC1 Over Voltage 2	AC1 voltage is above over voltage 2 threshold.	
AC1 Under Voltage 1	AC1 voltage is below under voltage 1 threshold.	Check why voltage is low.
AC1 Under Voltage 2	AC1 voltage is below under voltage 2 threshold.	
AC2 Over Voltage 1	AC2 voltage is above over voltage 1 threshold.	Check why voltage is high.
AC2 Over Voltage 2	AC2 voltage is above over voltage 2 threshold.	
AC2 Under Voltage 1	AC2 voltage is below under voltage 1 threshold.	Check why voltage is low.
AC2 Under Voltage 2	AC2 voltage is below under voltage 2 threshold.	
AC3 Over Voltage 1	AC3 voltage is above over voltage 1 threshold.	Check why voltage is high.
AC3 Over Voltage 2	AC3 voltage is above over voltage 2 threshold.	
AC3 Under Voltage 1	AC3 voltage is below under voltage 1 threshold.	Check why voltage is low.
AC3 Under Voltage 2	AC3 voltage is below under voltage 2 threshold.	
Mains Failure	Commercial AC power failure.	Check why no commercial AC power.
GEN AC Fail	AC generator power failure.	Check why no generator AC power.

**Table 2.3**

Alarm Name	Alarm Description	Action to Correct
<b>IB2-1 (Interface Board) Alarms (IB2-1 must be present in system)</b>		
Communication Fail	IB2-1 board has lost communications with the controller.	Check communications cables.
DI1 Alarm	Digital input #1 alarm is active.	Check why alarm is active.
...	...	
DI7 Alarm	Digital input #7 alarm is active.	
DI8 ESTOP	Digital input #8 alarm is active.	
IB2-1 D01 Test	Testing Relay 1 (on IB2-1 Board).	--
...	...	
IB2-1 D08 Test	Testing Relay 8 (on IB2-1 Board).	
<b>IB2-2 (Interface Board) Alarms (IB2-2 must be present in system)</b>		
Communication Fail	IB2-2 board has lost communications with the controller.	Check communications cables.
DI1 Alarm	Digital input #1 alarm is active.	Check why alarm is active.
...	...	
DI7 Alarm	Digital input #7 alarm is active.	
DI8 Alarm	Digital input #8 alarm is active.	
IB2-2 D01 Test	Testing Relay 1 (on IB2-2 Board).	--
...	...	
IB2-2 D08 Test	Testing Relay 8 (on IB2-2 Board).	
<b>EIB-1 (Extended Interface Board) Alarms (EIB-1 board must be present in system)</b>		
EIB Communication Fail	EIB-1 board has lost communications with the controller.	Check communications cables.
Bad Battery Block	Battery block fails.	Check batteries.
EIB-1 D01 Test	Testing Relay 1 (on EIB-1 Board).	--
...	...	
EIB-1 D05 Test	Testing Relay 5 (on EIB-1 Board).	
Current1 High 1 Curr	Current 1 above High 1 limit.	Check why current is high.
Current1 High 2 Curr	Current 1 above High 2 limit.	
Current2 High 1 Curr	Current 2 above High 1 limit.	
Current2 High 2 Curr	Current 2 above High 2 limit.	
Current3 High 1 Curr	Current 3 above High 1 limit.	
Current3 High 2 Curr	Current 3 above High 2 limit.	
<b>EIB-1 (Extended Interface Board) Battery Alarms (EIB-1 Board must be present in system)</b>		
Battery Current Limit Exceeded	Battery current limit point is exceeded.	--
Battery Over Current	Battery is in over current.	--
Battery Low Capacity	Battery has low capacity.	Check the batteries.
<b>EIB-2 (Extended Interface Board) Alarms (EIB-2 board must be present in system)</b>		
EIB Communication Fail	EIB-2 board has lost communications with the controller.	Check communications cables.
Bad Battery Block	Battery block fails.	Check batteries.

**Table 2.3**

Alarm Name	Alarm Description	Action to Correct
EIB-2 D01 Test	Testing Relay 1 (on EIB-2 Board).	--
...	...	
EIB-2 D05 Test	Testing Relay 5 (on EIB-2 Board).	
Current1 High 1 Current	Current 1 above High 1 limit.	Check why current is high.
Current1 High 2 Current	Current 1 above High 2 limit.	
Current2 High 1 Current	Current 2 above High 1 limit.	
Current2 High 2 Current	Current 2 above High 2 limit.	
Current3 High 1 Current	Current 3 above High 1 limit.	
Current3 High 2 Current	Current 3 above High 2 limit.	
...	...	
<b>EIB-2 (Extended Interface Board) Battery Alarms (EIB-2 Board must be present in system)</b>		
Battery Current Limit Exceeded	Battery current limit point is exceeded.	--
Battery Over Current	Battery is in over current.	--
Battery Low Capacity	Battery has low capacity.	Check the batteries.
<b>SMDU Unit 1 [2, 3, 4, 5, 6, 7, 8] Alarms (SMDU Module must be present in system)</b>		
Under Voltage	Distribution voltage is below under voltage threshold.	Check why system voltage is low.
Over Voltage	Distribution voltage is above over voltage threshold.	Check why system voltage is high.
Communication Fail	The SMDU 1 has lost communications with the Controller.	Check communications cables.
Current1 High 1 Current	Current 1 above High 1 limit.	Check why current is high.
Current1 High 2 Current	Current 1 above High 2 limit.	
...	...	
...	...	
Current5 High 1 Current	Current 5 above High 2 limit.	
Current5 High 2 Current	Current 5 above High 2 limit.	
Shunt1 Coefficient Conflict	Shunt 1 coefficient conflicting.	
...	...	
Shunt5 Coefficient Conflict	Shunt 4 coefficient conflicting.	Check why current is high.
Current1 High 1 Curr	Current 1 above High 1 limit.	
Current1 High 2 Curr	Current 1 above High 2 limit.	
...	...	
...	...	
Current5 High 1 Curr	Current 5 above High 1 limit.	
Current5 High 2 Curr	Current 5 above High 2 limit.	
<b>Converter Group Alarms</b>		
Multiple Converters Fail	More than one converter has failed.	Check input voltage to converters. Replace converters.
Converter Lost	A converter cannot be detected by the Controller.	Reset the Converter Lost alarm. Replace defective converter.
All Converters Comm Fail	No response from all converters.	Check the connectors and cables or the CAN loop. Replace the controller.
Over Current	Over current condition exists.	Check why.
Converter Protect	A converter is in protected mode.	Refer to Converter User Manual for troubleshooting information.
<b>Converter Alarms</b>		
Communication Fail	A converter has lost communications with the controller.	Check communications cables. Reset the Communication Fail alarm. Replace the converter.
Over Temperature	A converter has an over temperature condition.	Check why temperature is high.



**Table 2.3**

Alarm Name	Alarm Description	Action to Correct
HVSD Alarm	A converter has an overvoltage condition.	Refer to Converter User Manual for troubleshooting information.
Fan Fail	A converter's fan has failed.	Replace fan.
Power Limit	NOT IMPLEMENTED AT THIS TIME	NOT IMPLEMENTED AT THIS TIME
Low Input Volt	Input voltage to a converter is low.	--
Converter Fail	A converter has a fault condition.	Refer to Converter User Manual for troubleshooting information.
EEPROM Fail	A converter's EEPROM has failed.	
Thermal Shutdown	A converter is in thermal shutdown.	
Mod ID Overlap	Converter module ID's overlap.	--
Under Voltage	A converter has an under voltage condition. (The hysteresis value is 2V.)	--
Over Voltage	A converter has an over voltage condition. (The hysteresis value is 2V.)	--
Under Voltage (24V)	A converter has an under voltage condition. (The hysteresis value is 1V.)	--
Over Voltage (24V)	A converter has an over voltage condition. (The hysteresis value is 1V.)	--
Converter Summary Alarm	Converter alarm summary (one or more alarms designated as converter is active).	"Manufacturer Use" Only.
<b>SMDUP 1 [2, 3, 4, 5, 6, 7, 8] Unit Alarms (SMDU+ Module must be present in system)</b>		
Communication Fail	Communications failure.	Check communications cables.
Current1 High 1 Current	Current 1 above High 1 limit.	--
Current1 High 2 Current	Current 1 above High 2 limit.	--
...	...	--
...	...	--
Current25 High 1 Current	Current 25 above High 1 limit.	--
Current25 High 2 Current	Current 25 above High 2 limit.	--
Shunt Coefficient Conflict	Shunt coefficient conflicting.	Verify shunt size.
<b>Fuel Tank Group Alarms</b>		
Fuel Group Communication Failure	Fuel tank group communication failure.	Check communications cables.
<b>SMIO Generic Unit 1 Alarms (SM-IO Module must be present in system)</b>		
SMIO Failure	SMIO has failed.	--
<b>SMIO Generic Unit 3 [4, 5, 6, 7, 8] Alarms (SM-IO Module must be present in system)</b>		
High Analog Input 1 Alarm	Input #1 above high alarm threshold.	--
Low Analog Input 1 Alarm	Input #1 below low alarm threshold.	--
...	...	--
...	...	--
High Analog Input 5 Alarm	Input #5 above high alarm threshold.	--
Low Analog Input 5 Alarm	Input #5 below low alarm threshold.	--
High Frequency Input Alarm	Input frequency above high frequency alarm threshold.	--
Low Frequency Input Alarm	Input frequency below low frequency alarm threshold.	--
SMIO Failure	SM-IO board failure.	Replace the board.

**Table 2.3**

Alarm Name	Alarm Description	Action to Correct
Testing Relay 1	Testing Relay 1.	--
Testing Relay 2	Testing Relay 2.	
Testing Relay 3	Testing Relay 3.	
<b>Diesel Generator Group Alarms</b>		
Diesel Test in Progress	Diesel test in progress.	--
Diesel Generator Test Failure	Diesel test failed.	--
<b>Diesel Generator Alarms</b>		
Low DC Voltage	Generator has low DC voltage.	--
Diesel Generator Supervision Fai	Generator monitoring device has failed.	--
Diesel Generator Failure	Generator has failed.	--
Diesel Generator Connected	Generator is connected to the system.	--
Low Fuel Level	Generator has low fuel level.	--
High Water Temperature	Generator has high water temperature.	--
Low Oil Pressure	Generator has low oil pressure.	--
Periodical Maintenance Required	Periodical maintenance is required to be performed.	--
<b>SMDUH Unit 1 [2, 3, 4, 5, 6, 7, 8] Alarms (SMDUH Module must be present in system)</b>		
Under Voltage	Distribution voltage is below low voltage threshold.	Check why system voltage is low.
Over Voltage	Distribution voltage is above high voltage threshold.	Check why system voltage is high.
Communication Fail	The SMDUH has lost communications with the controller.	Check communications cables.
<b>OBFuel Tank Alarms</b>		
High Fuel Level Alarm	Fuel tank high level alarm.	--
Low Fuel Level Alarm	Fuel tank low level alarm.	--
Fuel Theft Alarm	Fuel tank theft alarm.	--
Tank Height Error	Fuel tank height error.	--
Fuel Tank Config Error	Fuel tank configuration error.	--
<b>SM Temp Group Alarms (SM-Temp Module must be present in system)</b>		
SM Temp Lost	SM-Temp cannot be detected by the controller.	Reset the SMTemp Lost alarm. Replace defective SM-Temp.
<b>SM Temp 1-8 Alarms (SM-Temp Module must be present in system)</b>		
Communication Fail	SM-Temp has lost communications with the controller.	Check communications cables.
Temperature Probe 1 Shorted	Probe shorted.	Replace temperature probe.
...	...	
Temperature Probe 8 Shorted	Probe shorted.	Replace temperature probe.
Temperature Probe 1 Open	Probe open.	
...	...	
Temperature Probe 8 Open	Probe open.	
<b>SM DUE 1-8 Alarms (SM-DUE Module must be present in system)</b>		
Communication Fail	SM-DUE has lost communications with the controller.	Check communications cables.

**Table 2.3**

Alarm Name	Alarm Description	Action to Correct
Current1 High 1 Current	Current 1 above High 1 limit.	Check why current is high.
Current1 High 2 Current	Current 1 above High 2 limit.	
...	...	...
Current10 High 1 Current	Current 10 above High 1 limit.	Check why current is high.
Current10 High 2 Current	Current 10 above High 2 limit.	
SMDUE1 Temp 1 Not Used	Temperature sensor port #1 on SMDUE1 is not used.	Temperature probe is enabled but not plugged in.
...	...	
SMDUE1 Temp 10 Not Used	Temperature sensor port #10 on SMDUE1 is not used.	Replace temperature sensor.  Note: The alarm "Temp Sensor Fail" will occur if the temperature probe fails internally or is not plugged in; however, this alarm will be suppressed if "Temp Not Used" alarm is active.
SMDUE1 Temp 1 Sensor Fail	Temperature sensor #1 on SMDUE1 failure.	
...	...	
SMDUE1 Temp 10 Sensor Fail	Temperature sensor #10 on SMDUE1 failure.	
Voltage1 Low1 Volt Alarm	Monitored Voltage1 is lower than the Low1 Volt Alarm threshold.	Check why voltage is high or low.
Voltage1 Low2 Volt Alarm	Monitored Voltage1 is lower than the Low2 Volt Alarm threshold.	
Voltage1 High1 Volt Alarm	Monitored Voltage1 is higher than the High1 Volt Alarm threshold.	
Voltage1 High2 Volt Alarm	Monitored Voltage1 is higher than the High2 Volt Alarm threshold.	
...	...	...
Voltage10 Low1 Volt Alarm	Monitored Voltage10 is lower than the Low1 Volt Alarm threshold.	Check why voltage is high or low.
Voltage10 Low2 Volt Alarm	Monitored Voltage10 is lower than the Low2 Volt Alarm threshold.	
Voltage10 High1 Volt Alarm	Monitored Voltage10 is higher than the High1 Volt Alarm threshold.	
Voltage10 High2 Volt Alarm	Monitored Voltage10 is higher than the High2 Volt Alarm threshold.	
TranVolt1 Low1 Volt Alarm	Monitored Transducer Voltage1 is lower than the Low1 Volt Alarm threshold.	Check why voltage is high or low.
TranVolt1 Low2 Volt Alarm	Monitored Transducer Voltage1 is lower than the Low2 Volt Alarm threshold.	
TranVolt1 High1 Volt Alarm	Monitored Transducer Voltage1 is higher than the High1 Volt Alarm threshold.	
TranVolt1 High2 Volt Alarm	Monitored Transducer Voltage1 is higher than the High2 Volt Alarm threshold.	
...	...	...
TranVolt10 Low1 Volt Alarm	Monitored Transducer Voltage10 is lower than the Low1 Volt Alarm threshold.	Check why voltage is high or low.
TranVolt10 Low2 Volt Alarm	Monitored Transducer Voltage10 is lower than the Low2 Volt Alarm threshold.	
TranVolt10 High1 Volt Alarm	Monitored Transducer Voltage10 is higher than the High1 Volt Alarm threshold.	
TranVolt10 High2 Volt Alarm	Monitored Transducer Voltage10 is higher than the High2 Volt Alarm threshold.	

**Table 2.3**

Alarm Name	Alarm Description	Action to Correct
TranCurr1 Low1 Curr Alarm	Monitored Transducer Current1 is lower than the Low1 Curr Alarm threshold.	Check why current is high or low.
TranCurr1 Low2 Curr Alarm	Monitored Transducer Current1 is lower than the Low2 Curr Alarm threshold.	
TranCurr1 High1 Curr Alarm	Monitored Transducer Current1 is higher than the High1 Curr Alarm threshold.	
TranCurr1 High2 Curr Alarm	Monitored Transducer Current1 is higher than the High2 Curr Alarm threshold.	
...	...	...
TranCurr10 Low1 Curr Alarm	Monitored Transducer Current10 is lower than the Low1 Curr Alarm threshold.	Check why current is high or low.
TranCurr10 Low2 Curr Alarm	Monitored Transducer Current10 is lower than the Low2 Curr Alarm threshold.	
TranCurr10 High1 Curr Alarm	Monitored Transducer Current10 is higher than the High1 Curr Alarm threshold.	
TranCurr10 High2 Curr Alarm	Monitored Transducer Current10 is higher than the High2 Curr Alarm threshold.	
<b>SMDUEDCFuseUnit 1-8 (SM-DUE Module must be present in system) Alarms</b>		
DC Fuse 1 Alarm	DC fuse #1 is open.	Find out and eliminate the reason the fuse is open before replacing. Check for overload or short circuit. If the fuse was manually removed, check with the person that removed it before reinserting it.
...	...	
DC Fuse 10 Alarm	DC fuse #10 is open.	
<b>Inverter Group (module must be present in system) Alarms</b>		
Inverter Lost	An inverter cannot be detected by the controller.	Reset the Inverter Lost Alarm. Replace defective inverter.
All Inverters Comm Fail	No response from all inverters.	Check the connectors and cables or CAN loop.
Inverter High Load	Inverter has high load.	Check why inverter has high load.
Synchronization Phase Failure	Inverters phase not in sync.	Check cables between inverter shelves. Replace inverter.
Synchronization Voltage Failure	Inverters voltage not in sync.	--
Synchronization Frequency Failure	Inverters frequency not in sync.	--
Synchronization Mode Failure	Inverters mode not in sync.	--
<b>Inverter (module must be present in system) Alarms</b>		
Inverter Communication Fail	No response from inverter.	Reset the Inverter Lost Alarm. Replace defective inverter.
Inverter Fail	An inverter has a fault condition.	Refer to Inverter User Manual for troubleshooting information.
Input AC Volt Abnormal	An inverter has an AC input voltage condition.	--
Input DC Volt Abnormal	An inverter has a DC input voltage condition.	--
Over Temperature	An inverter has an over temperature condition.	--
Fan Fail	An inverter has a fan condition.	--
About Over Load	An inverter is near to being over loaded.	--
Over Load	An inverter has an overload condition.	Check why inverter is over loaded.
Module ID Repeated	An inverter has an ID repeated.	Refer to Inverter User Manual for troubleshooting information.
Parallel Flow Anomaly	An inverter has a parallel flow condition.	--
Parallel Out of Sync	An inverter has a parallel sync condition.	--
Parallel CAN Comm Fail	An inverter has a parallel CAN Comm condition.	--
Phase Anomaly	An inverter has a phase condition.	--
Over Load Times Up Limit	An inverter has been in overload for allotted time.	--

**Table 2.3**

Alarm Name	Alarm Description	Action to Correct
Software Remote Stop	An inverter has been stopped by software.	--
Hardware Remote Stop	An inverter has been stopped by hardware.	--
Low Output Voltage	An inverter has a low output voltage.	--
<b>SoNick Battery Alarms</b>		
Battery Communication Fail	Refer to the documentation provided with the FIAMM SoNick (Sodium Nickel) Battery.	
Low Ambient Temperature		
High Ambient Temperature Warning		
High Ambient Temperature		
Low Battery Internal Temp		
High Batt Internal Temp Warning		
High Batt Internal Temperature		
Bus Voltage Below 40V		
Bus Voltage Below 39V		
Bus Voltage Above 60V		
Bus Voltage Above 65V		
High Discharge Current Warning		
High Discharge Current		
Main Switch Error		
Fuse Blown		
Heaters Failure		
Thermocouple Failure		
Voltage Measurement Circuit Fail		
Current Measurement Circuit Fail		
BMS Hardware Failure		
Hardware Protection Sys Active		
Heatsink High Temperature		
Battery Voltage Below 39V		
Battery Voltage Below 38V		
Battery Voltage Above 53.5V		
Battery Voltage Above 53.6V		
High Charge Current Warning		
High Charge Current		
High Discharge Current Warning		
High Discharge Current		
Voltage Unbalance Warning		
Voltages Unbalance		
DC Bus Pwr Too Low for Charging		
Charge Regulation Failure		
Capacity Below 12.5%		
Thermocouples Mismatch		
Heater Fuse Blown		

### 3 Local Display Menus

#### 3.1 Overview

This section provides descriptions of the local display menus. Refer also to “Passwords and Privilege Levels” on page 19 and “Description of Local Display Menu Programmable Parameters” on page 95. For Web interface, refer to “Web Interface Screens” on page 101.

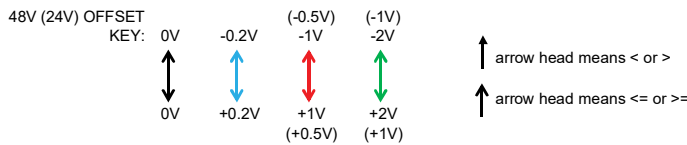
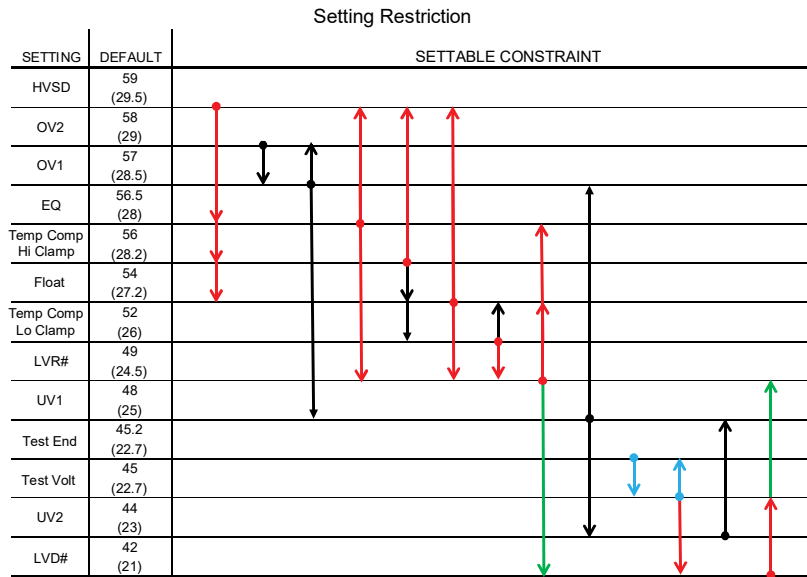
#### 3.2 Factory Default Setpoints

Refer to the Configuration Drawing (C-drawing) furnished with your system for a list of factory default values.

#### 3.3 Adjustment Range Restrictions

See Figure 3.1.

Figure 3.1 Adjustment Range Restrictions



- Setting HVSD:** HVSD >= Float +1 for 48V, +0.5 for 24V  
HVSD >= EQ +1 for 48V, +0.5 for 24V  
HVSD >= \* Hi Clamp +1 for 48V, +0.5 for 24V
- Setting OV2:** OV2 >= OV1
- Setting OV1:** OV1 <= OV2  
OV1 > UV1
- Setting EQ:** EQ >= \* LVR# +1 for 48V, +0.5 for 24V  
EQ <= \* HVSD -1 for 48V, -0.5 for 24V
- Setting Temp Comp Hi Clamp:** Hi Clamp >= Float  
Hi Clamp > Lo Clamp  
Hi Clamp <= \* HVSD -1 for 48V, -0.5 for 24V
- Setting Float:** Float >= \* LVR# +1 for 48V, +0.5 for 24V  
Float <= \* HVSD -1 for 48V, -0.5 for 24V
- Setting Temp Comp Lo Clamp:** Lo Clamp <= Float  
Lo Clamp >= \* LVR# +1 for 48V, +0.5 for 24V
- Setting LVR#:** LVR# <= Float -1 for 48V, -0.5 for 24V  
LVR# <= EQ -1 for 48V, -0.5 for 24V  
LVR# >= LVD# +2 for 48V, +1 for 24V
- Setting UV1:** UV1 >= UV2  
UV1 < OV1
- Setting Test End:** Test End >= Test Volt +0.2
- Setting Test Volt:** Test Volt <= Test End -0.2  
Test Volt >= \* LVDx +1 for 48V, +0.5 for 24V
- Setting UV2:** UV2 <= UV1
- Setting LVD#:** LVD# <= LVR# -2 for 48V, -1 for 24V  
LVD# <= Test Volt -1 for 48V, -0.5 for 24V

\* These restrictions will apply even if the function is disabled.

### 3.4 Main Screen

The MAIN SCREEN is shown in Figure 3.2. This is the first screen displayed when the local display is activated by pressing any key on the controller's front panel.

Figure 3.2 MAIN SCREEN

MAIN SCREEN

54.3V	0.0A	▲
Auto	Alarm	▼

To reboot the Controller, from the Main Screen press the ENT and ESC keys at the same time. Release both keys. Press ENT to confirm.

### 3.5 Information Screens (accessed from the MAIN SCREEN)

Information screens can be accessed from the MAIN SCREEN as shown in Figure 3.3 and Figure 3.4.

Figure 3.3 Information Screens (using UP and DOWN arrow keys)

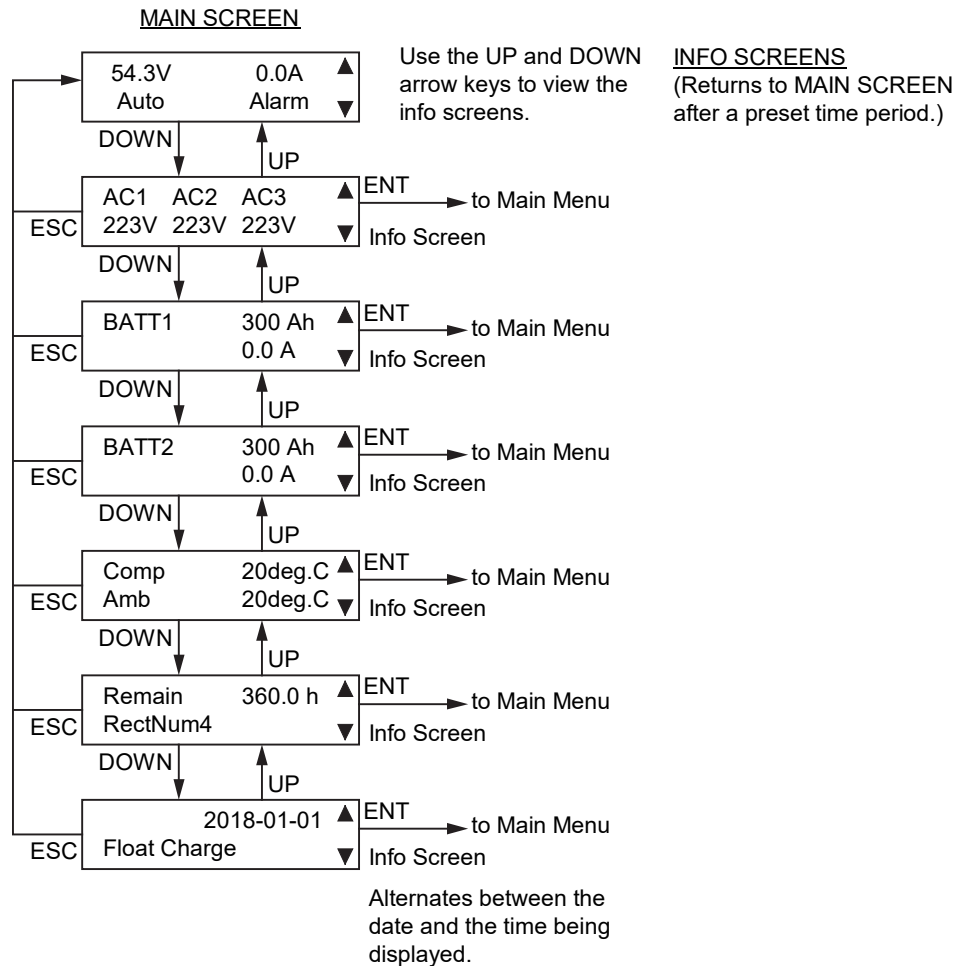
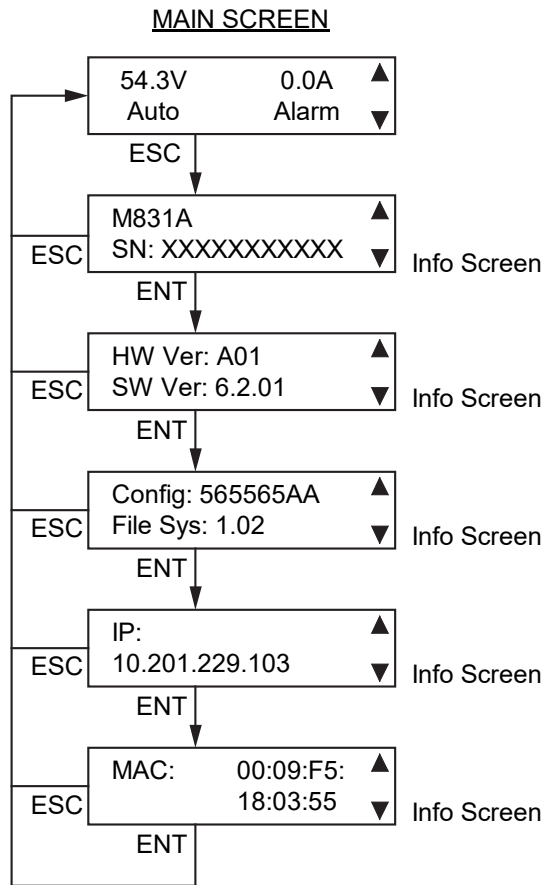


Figure 3.4 Information Screens (Using ESC and ENT Keys)



Use the ESC and ENT key to view the info screens.

INFO SCREENS  
(Returns to MAIN SCREEN after a preset time period.)



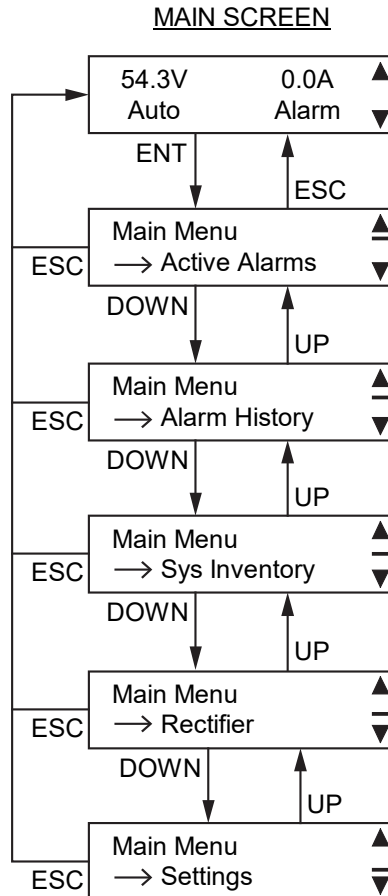
### 3.6 Main Menu

From the MAIN SCREEN, press the ENT key to go to the MAIN MENU. From the MAIN MENU, you can press the UP and DOWN arrow keys to select a submenu. Press the ENT key to enter the selected submenu. See Figure 3.5. Refer to the next section for submenu illustrations.



**NOTE!** Repeatedly press the ESC key to return in reverse order level by level from any submenu until the MAIN SCREEN appears.

Figure 3.5 MAIN MENU



### 3.7 Local Display Menus

Figure 3.6 provides flow diagrams of the menus accessed via the controller local display and keypad.



**NOTE!** These instructions describe the complete functionality of the controller. Some functionality is dependent on hardware connected to the controller. Some menu items shown may not be present in the controller used in your system.

Figure 3.6 Local Display Menus (cont'd on next page)

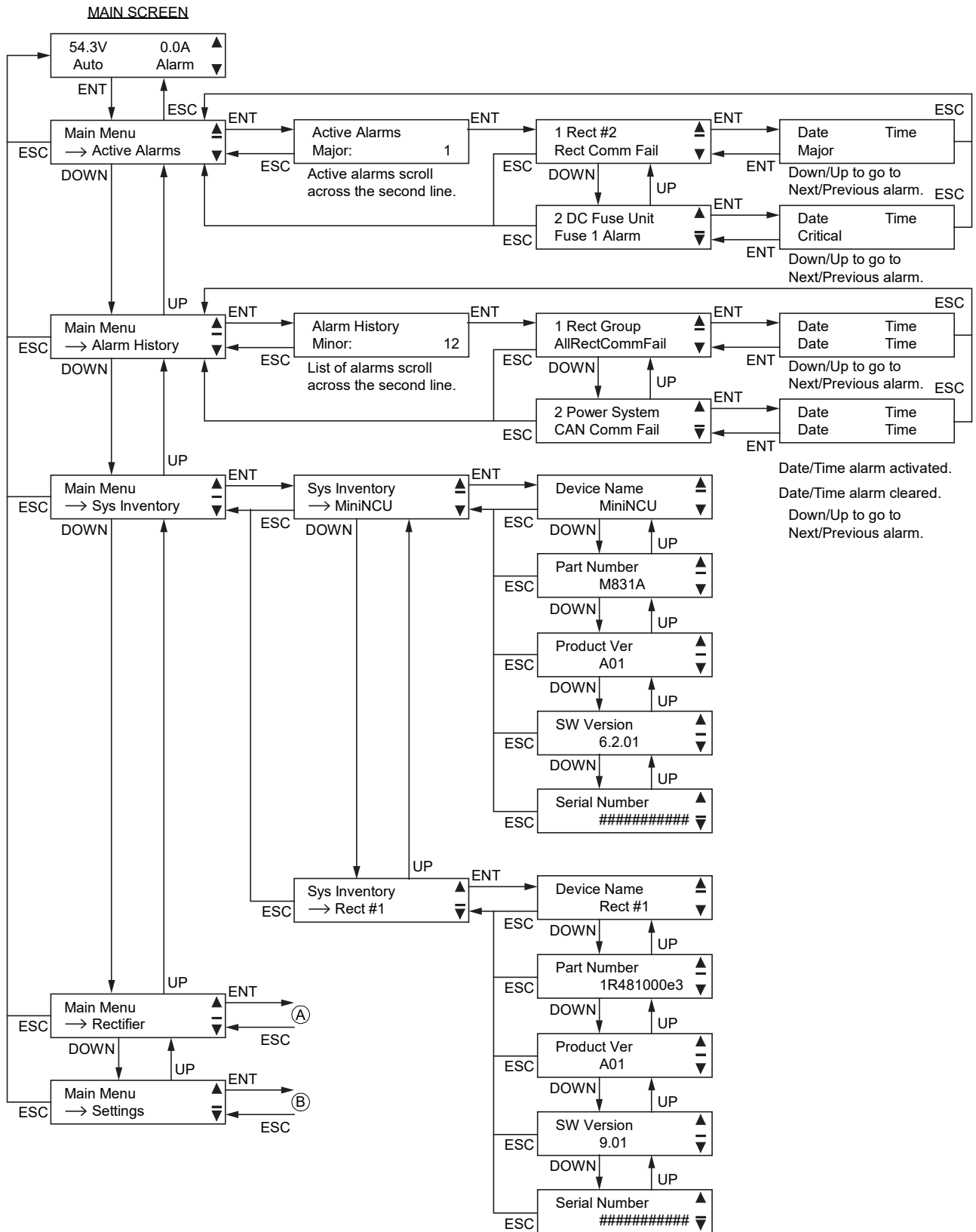


Figure 3.6 Local Display Menus (cont'd from previous page, cont'd on next page)

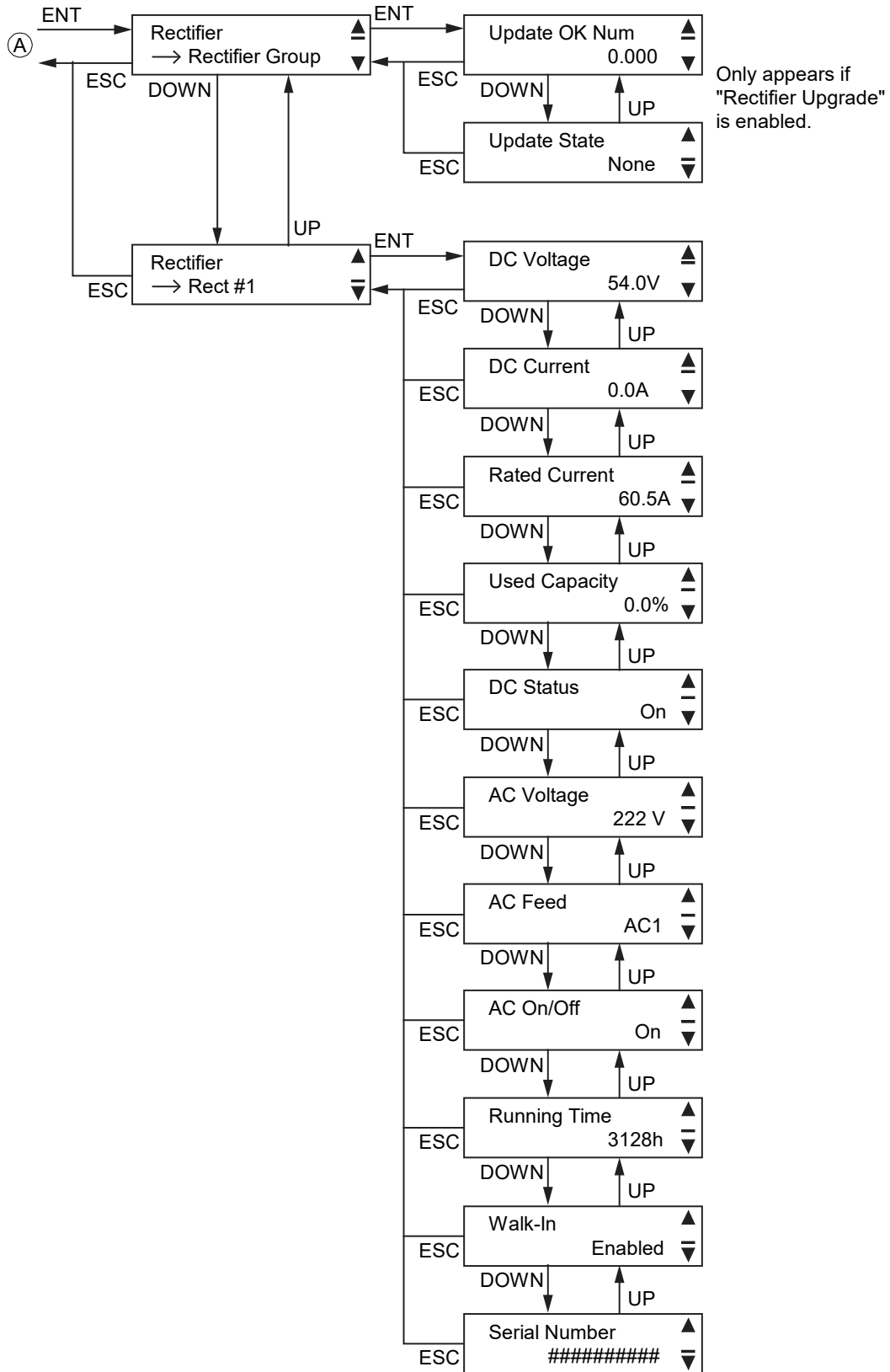
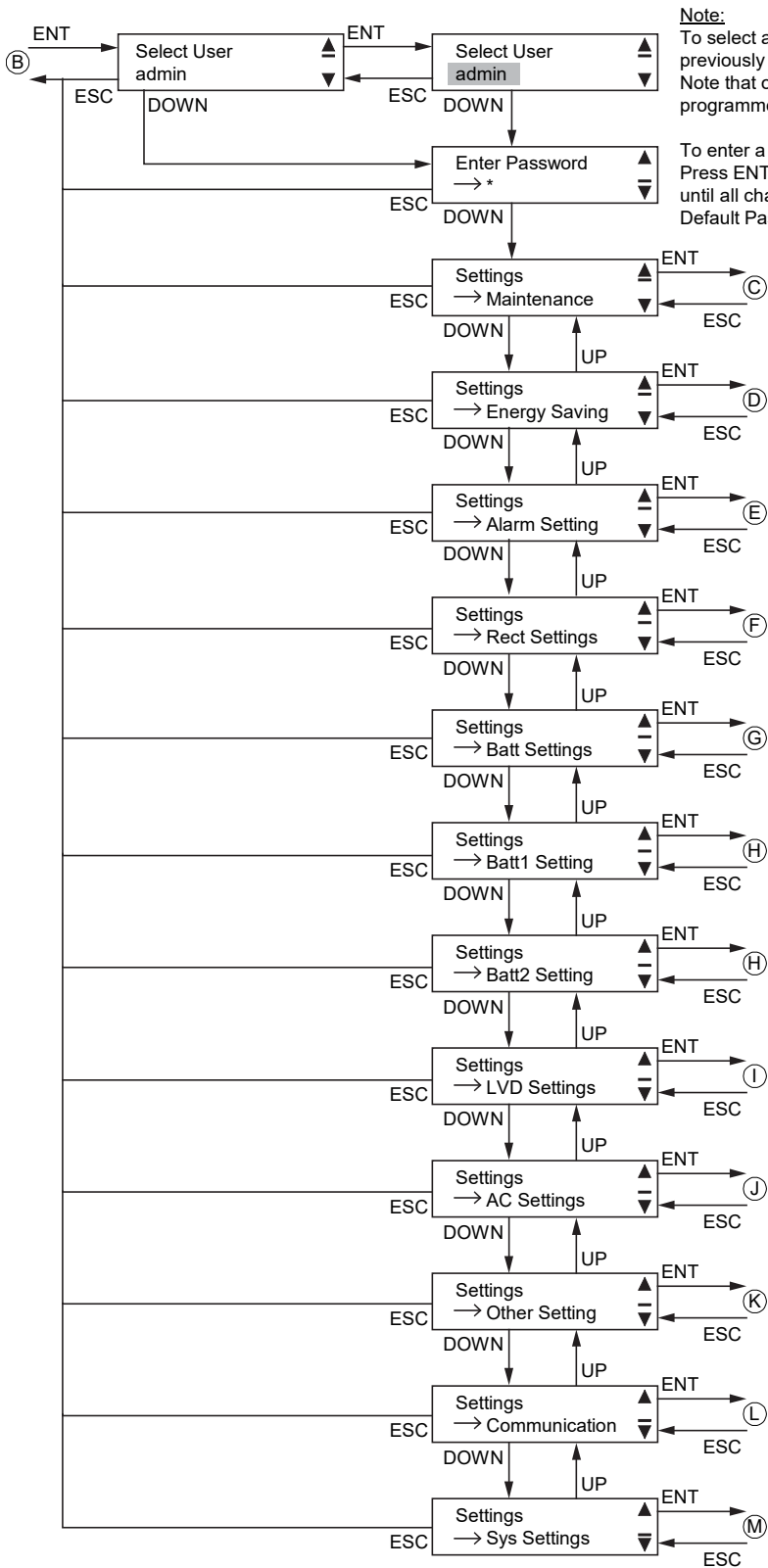


Figure 3.6 Local Display Menus (cont'd from previous page, cont'd on next page)



**Note:**

To select a User, use the UP and DOWN arrow keys to select a User previously programmed into the controller. Press ENT to select the User. Note that only Users programmed into the controller are shown. Users are programmed via the Web Interface.

To enter a password, use the UP and DOWN keys to choose a character. Press ENT to accept and move to the next character. Continue this process until all characters are entered. Press ENT again to accept the password. Default Password: 640275

Figure 3.6 Local Display Menus (cont'd from previous page, cont'd on next page)

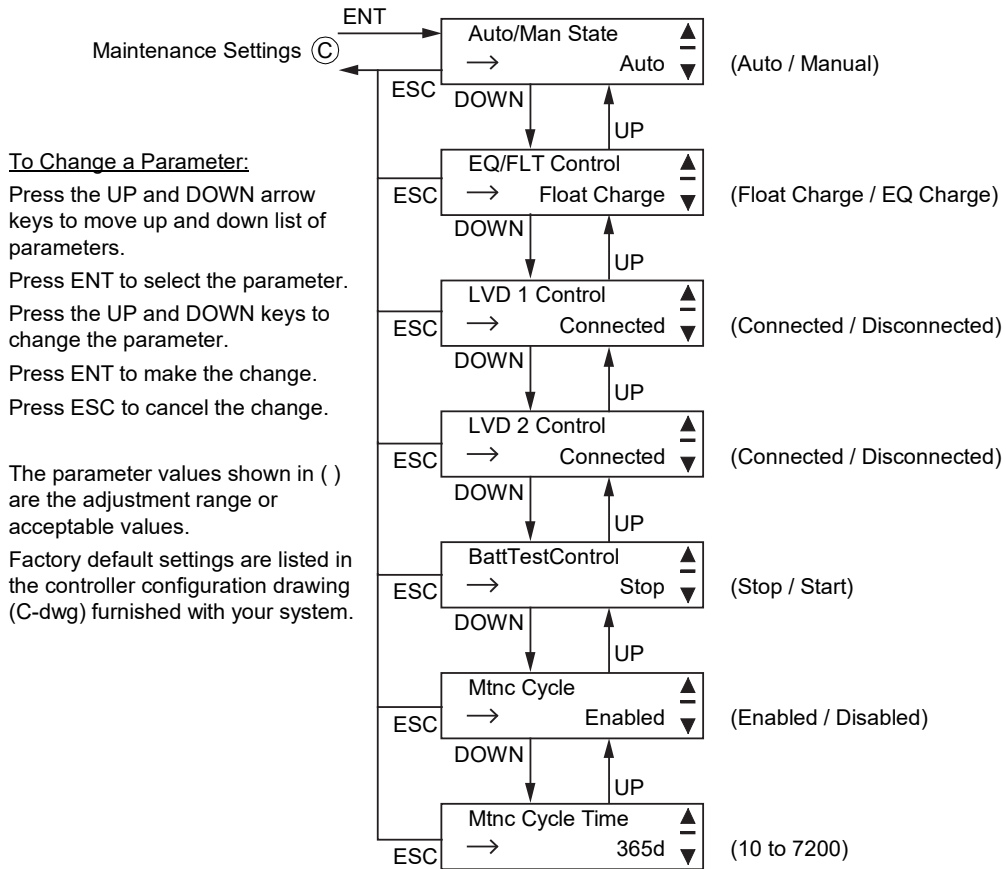


Figure 3.6 Local Display Menus (cont'd from previous page, cont'd on next page)

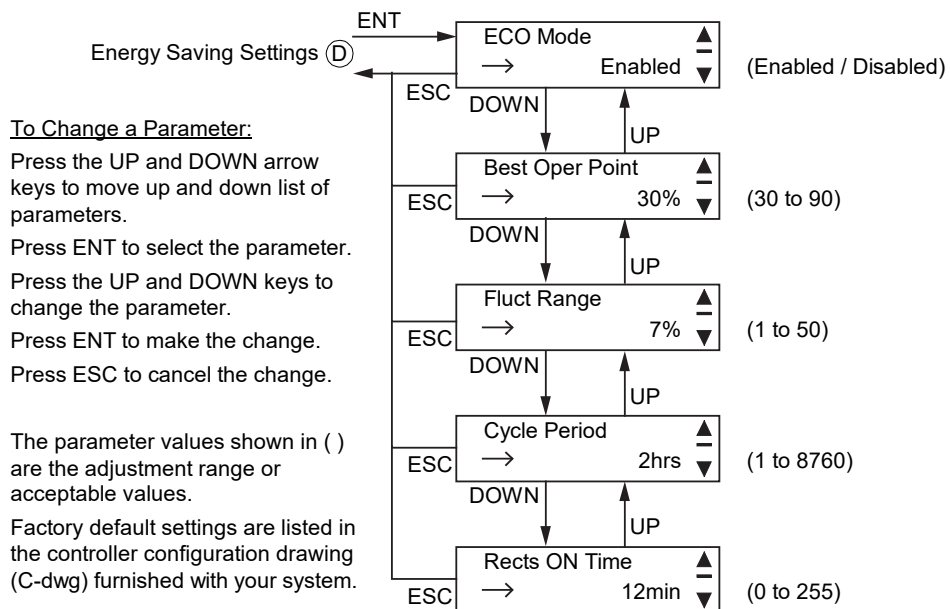
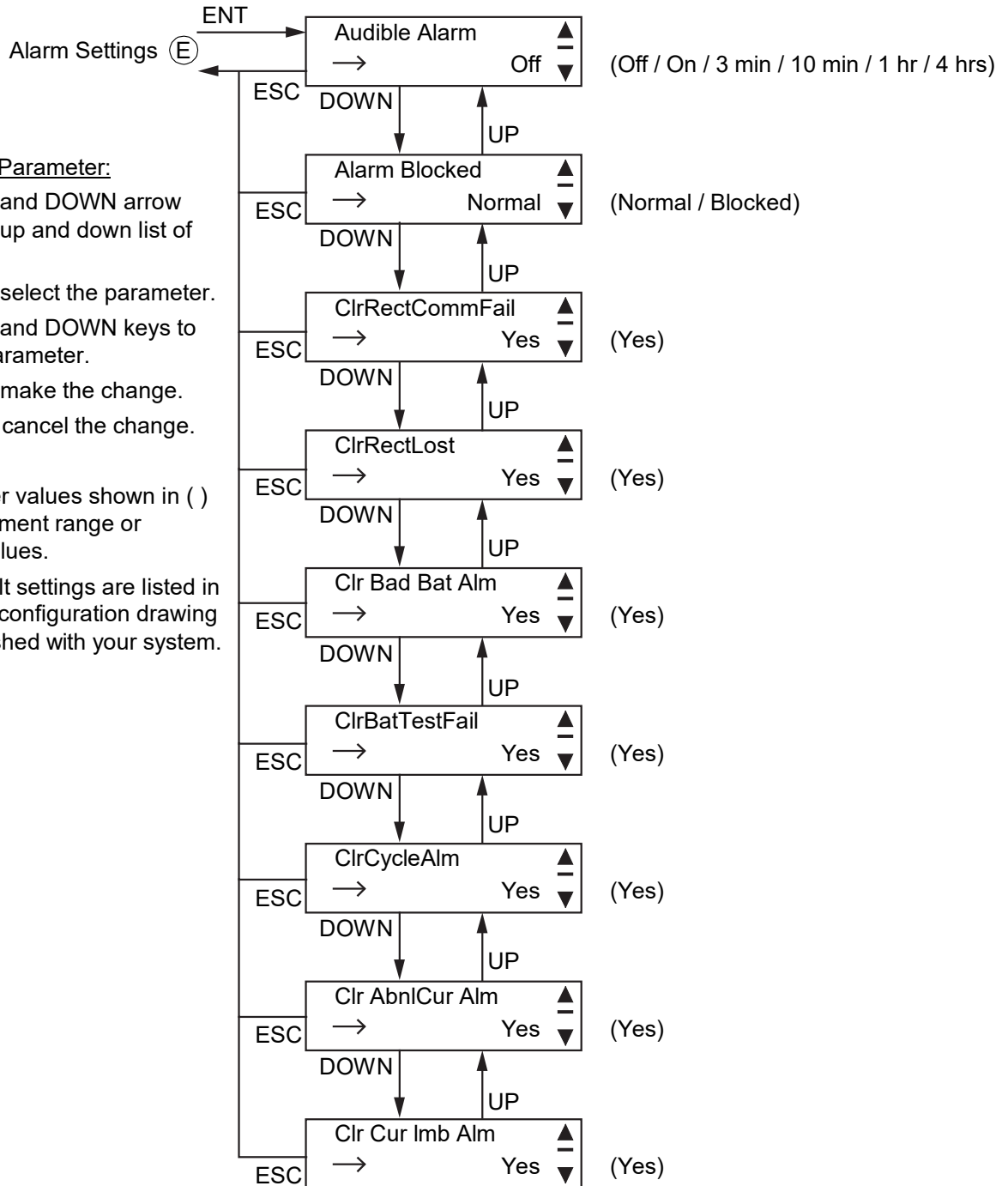


Figure 3.6 Local Display Menus (cont'd from previous page, cont'd on next page)



To Change a Parameter:

Press the UP and DOWN arrow keys to move up and down list of parameters.

Press ENT to select the parameter.

Press the UP and DOWN keys to change the parameter.

Press ENT to make the change.

Press ESC to cancel the change.

The parameter values shown in ( ) are the adjustment range or acceptable values.

Factory default settings are listed in the controller configuration drawing (C-dwg) furnished with your system.

Figure 3.6 Local Display Menus (cont'd from previous page, cont'd on next page)

To Change a Parameter:

Press the UP and DOWN arrow keys to move up and down list of parameters.

Press ENT to select the parameter.

Press the UP and DOWN keys to change the parameter.

Press ENT to make the change.

Press ESC to cancel the change.

The parameter values shown in ( ) are the adjustment range or acceptable values.

Factory default settings are listed in the controller configuration drawing (C-dwg) furnished with your system.

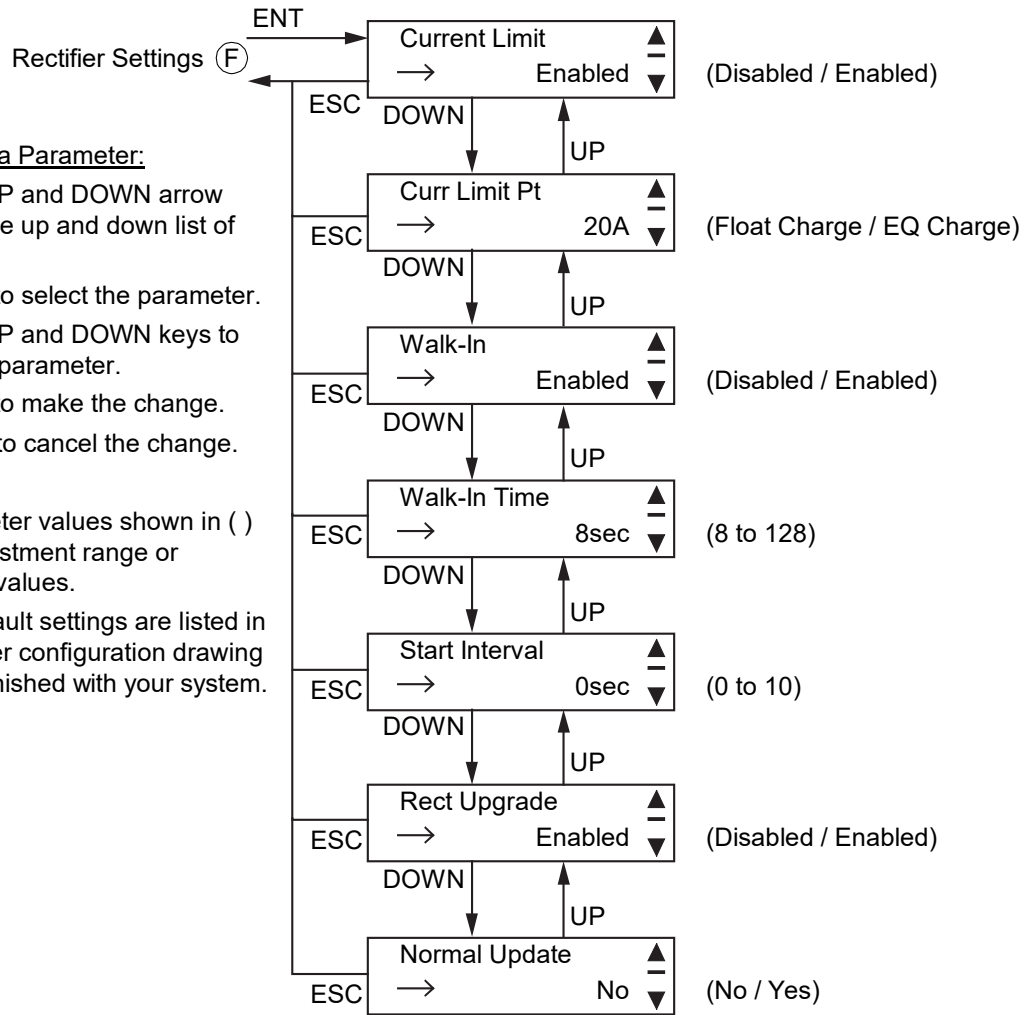


Figure 3.6 Local Display Menus (cont'd from previous page, cont'd on next page)

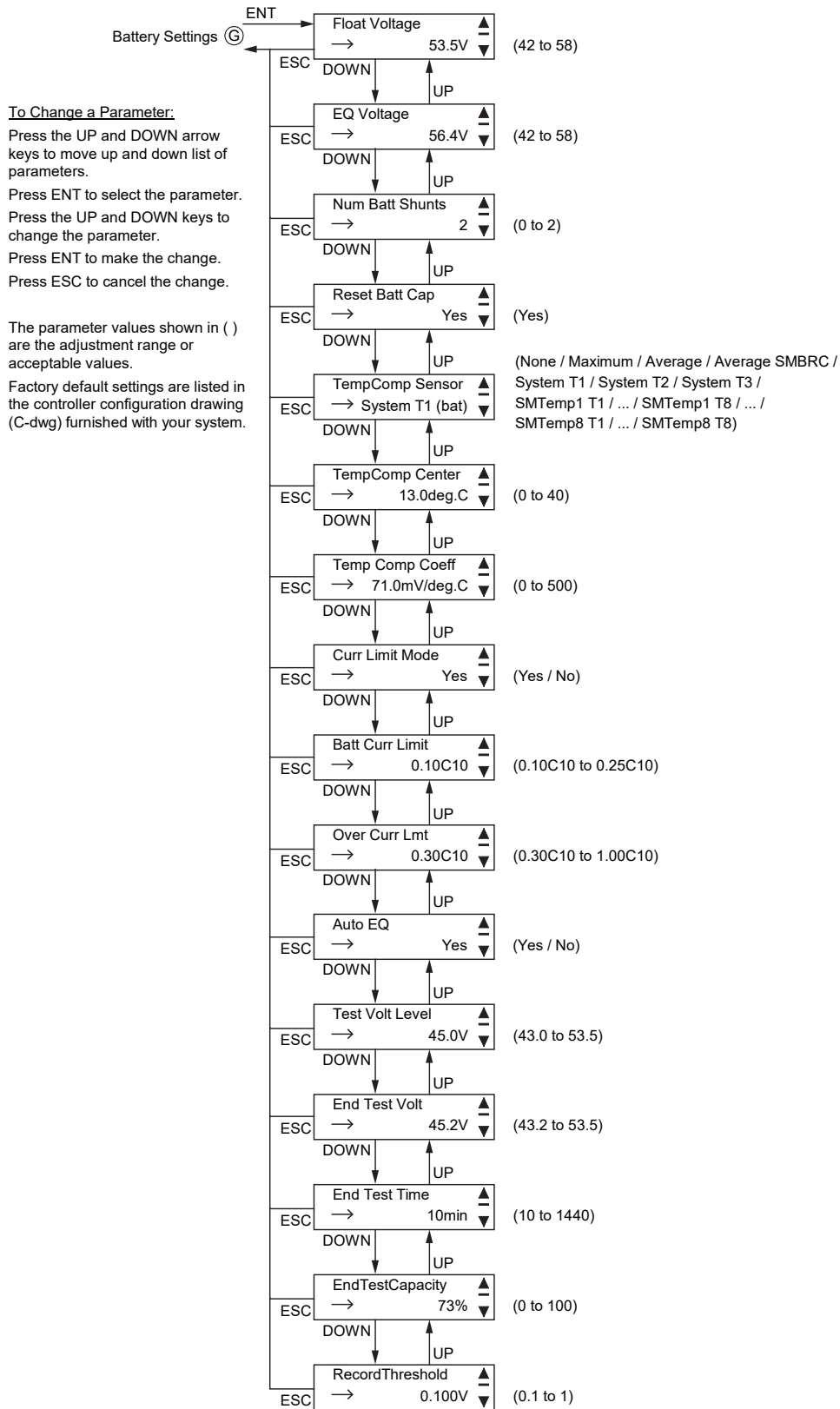
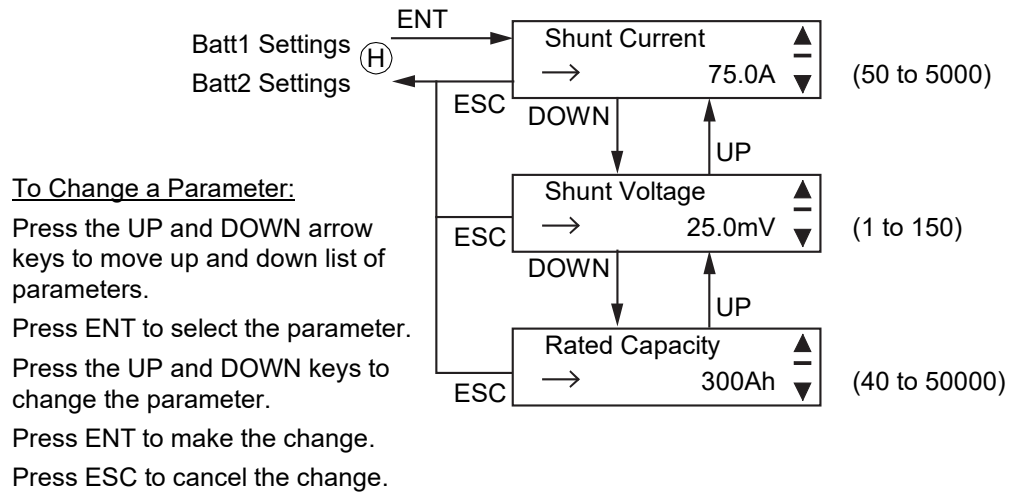




Figure 3.6 Local Display Menus (cont'd from previous page, cont'd on next page)



The parameter values shown in ( ) are the adjustment range or acceptable values.

Factory default settings are listed in the controller configuration drawing (C-dwg) furnished with your system.

Figure 3.6 Local Display Menus (cont'd from previous page, cont'd on next page)

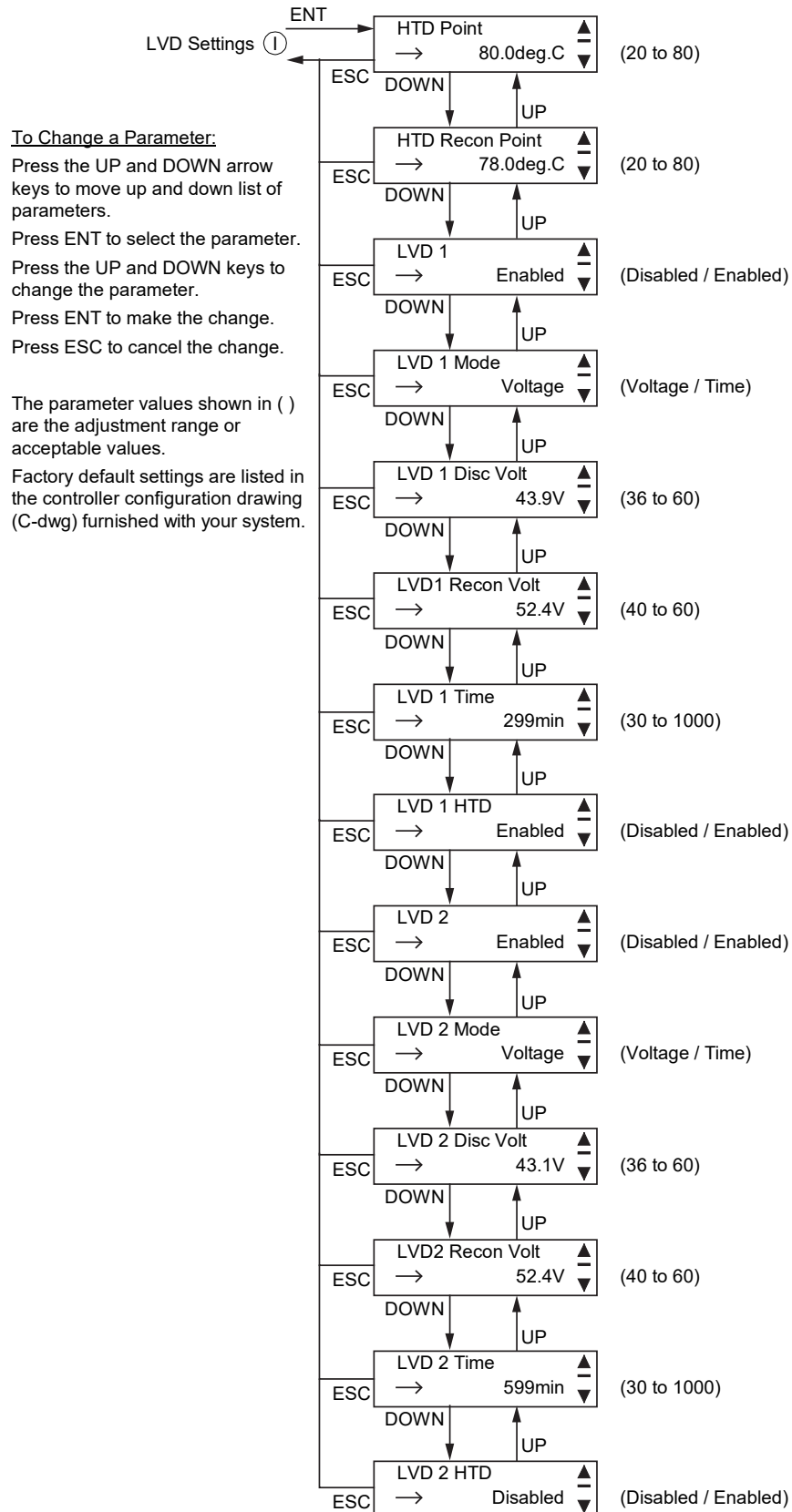
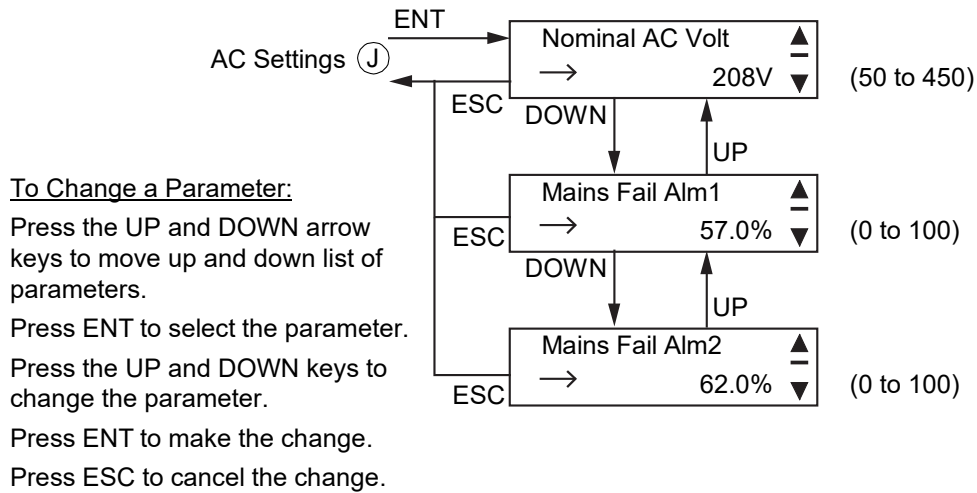


Figure 3.6 Local Display Menus (cont'd from previous page, cont'd on next page)



The parameter values shown in ( ) are the adjustment range or acceptable values.

Factory default settings are listed in the controller configuration drawing (C-dwg) furnished with your system.

Figure 3.6 Local Display Menus (cont'd from previous page, cont'd on next page)

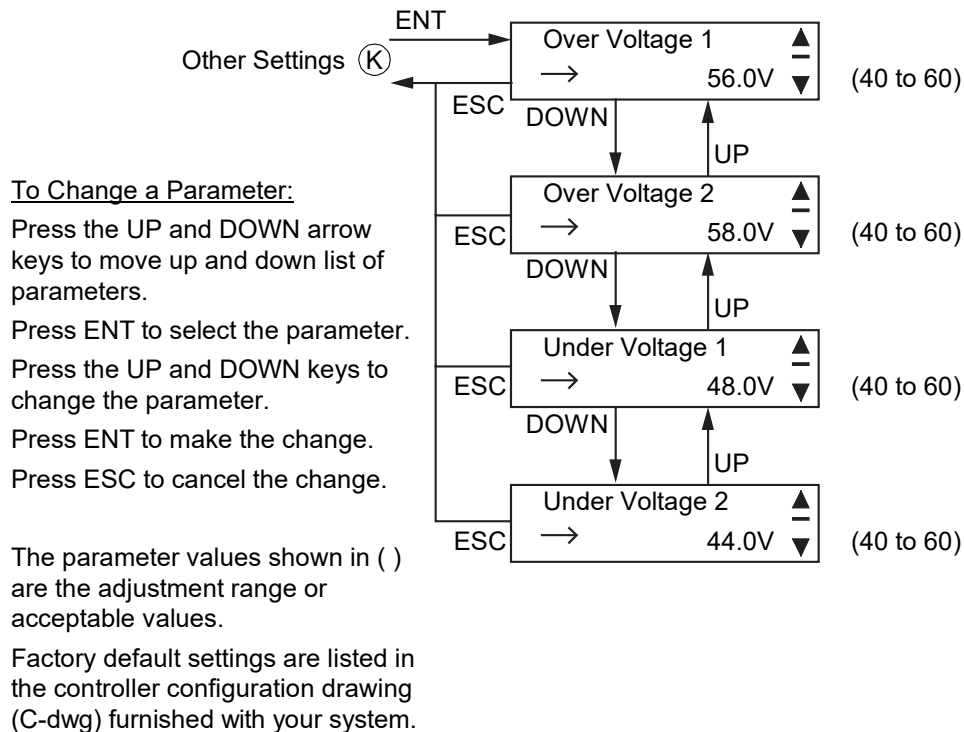


Figure 3.6 Local Display Menus (cont'd from previous page, cont'd on next page)

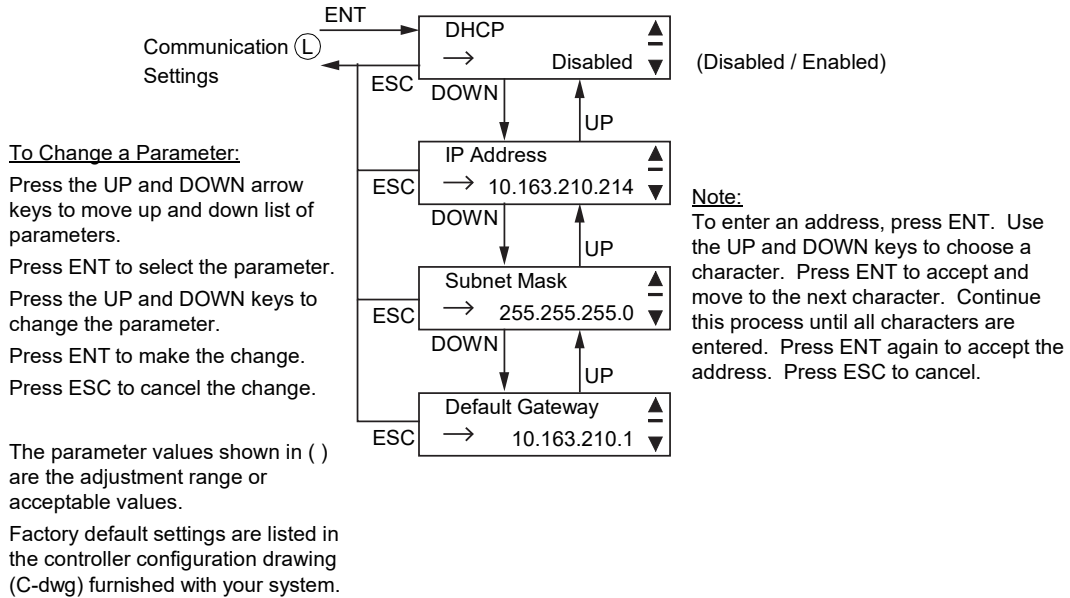
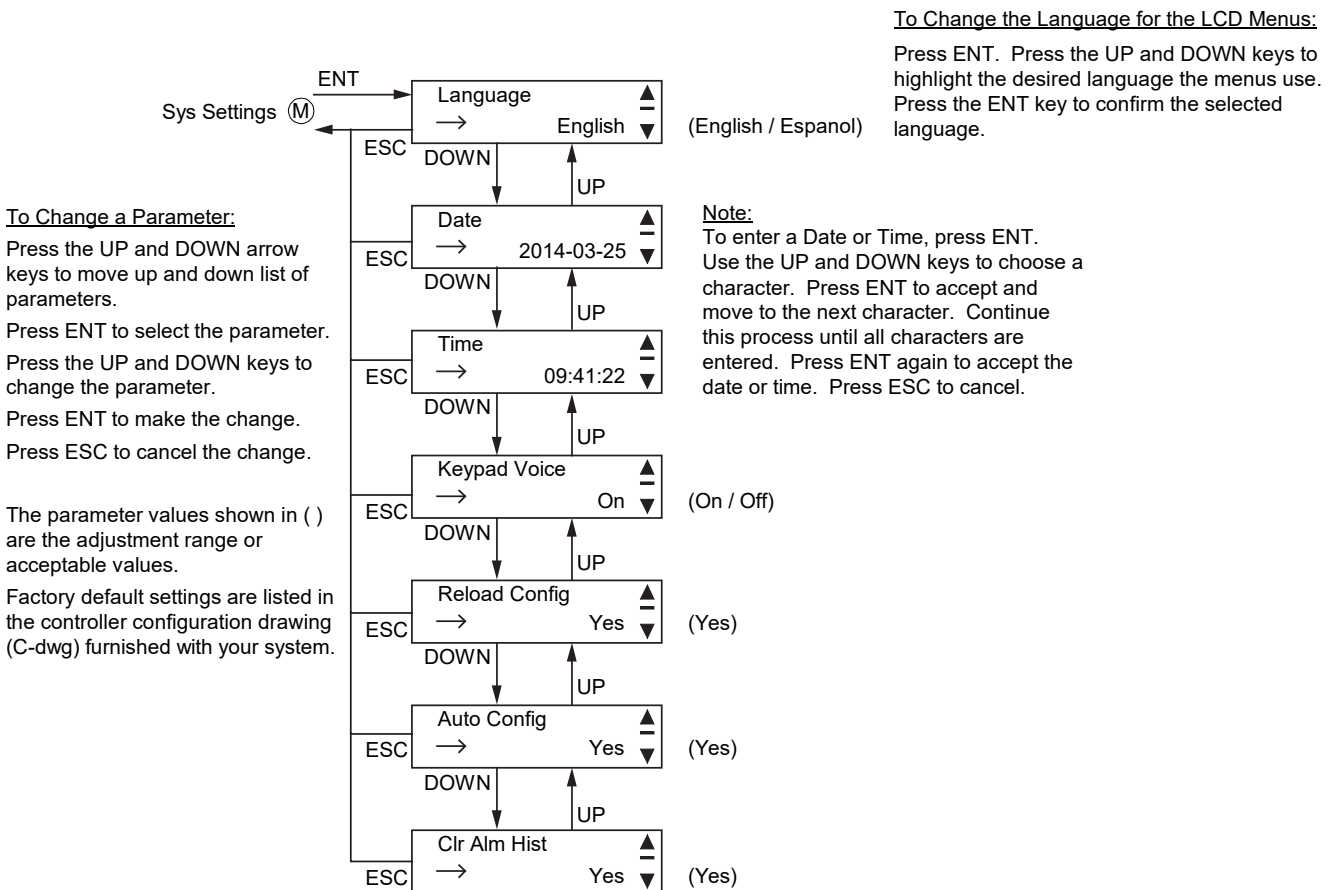


Figure 3.6 Local Display Menus (cont'd from previous page)



## 4 Description of Local Display Menu Programmable Parameters

The following are descriptions of the programmable parameters presented in the local display menus.



**NOTE!** Some parameters are not available for controller configurations that enable controller capability to receive status information sent from FIAMM SoNick (Sodium Nickel) batteries.

### 4.1 Settings Menu

See Figure 3.6.

#### 4.1.1 Maintenance Sub-Menu

- **Auto/Man State:**
  - **Auto:** The controller automatically controls the power system.
  - **Manual:** A User can manually change certain power system control settings. When you return to Auto Mode, any settings changed in Manual Mode are returned to their previous setting (setting before being placed in Manual Mode). This provides a convenient means of making temporary adjustment changes for testing purposes.
- **EQ/FLT Control:** Places the system in Equalize Charge or Float Charge mode.
- **LVD 1 Control:** Temporarily connects or disconnects LVD 1 when the controller is in Manual mode. Setting returns to original when controller is returned to the Auto mode.
- **LVD 2 Control:** Temporarily connects or disconnects LVD 2 when the controller is in Manual mode. Setting returns to original when controller is returned to the Auto mode.
- **BattTestControl:** Starts or stops battery test.
- **Mtnc Cycle:** Enables or disables the maintenance cycle timer. When enabled, the following parameter can be set.
- **Mtnc Cycle Time:** The maintenance cycle time is the number of days before a maintenance alarm is issued. To reset the maintenance timer and clear the maintenance alarm, clear the maintenance run time (see “Clearing the Maintenance Alarm” on page 41).

#### 4.1.2 Energy Saving Sub-Menu

- **ECO Mode:** Enables or disables the Energy Optimization Mode feature for all rectifiers. When enabled, the following parameters can be set.



**ALERT!** The Energy Optimization Mode should NOT be used in systems that operate without batteries.

- **Best Oper Point:** Percent of full load capacity that the rectifiers operate under in the Energy Optimization mode.
- **Fluct Range:** If load fluctuation is less than this value, rectifiers are not turned on or off for Energy Optimization.
- **Cycle Period:** This is the time period that rectifiers are turned on and off to maintain an equal operating time for all rectifiers in the system.
- **Rects ON Time:** Time all rectifiers are turned on at the end of the “Cycle Period”.

### 4.1.3 Alarm Setting Sub-Menu

- **Audible Alarm:** Programs the audible alarm feature.
  - **Off:** Disables the audible alarm.
  - **On:** When a new alarm occurs, the audible alarm sounds. Press any key to silence the audible alarm.
  - **3 min / 10 min / 1 hr / 4 hrs:** When a new alarm occurs, the audible alarm sounds. The audible alarm automatically silences after the selected time period.
- **Alarm Blocked:**
  - **Normal:** Alarms are processed normally.
  - **Blocked:** Forces the alarm relays in the "off" state and blocks alarms from changing the relay state.
- **ClrRectCommFail:** Clears a rectifier communication fail alarm.
- **ClrRectLost:** Clears a rectifier lost alarm.
- **Clr Bad Bat Alm:** Clears a bad battery alarm.
- **ClrBatTestFail:** Clears a battery test fail alarm.
- **ClrCycleAlm:** Clears a rectifier oscillator alarm.
- **Clr AbnlCur Alm:** Clears an abnormal current alarm.
- **Clr Cur Imb Alm:** Clears a current imbalance alarm.

### 4.1.4 Rect Settings Sub-Menu

- **Current Limit:** Enables or disables adjusting the output current limit point.



**NOTE!** By default this is set to disabled. When disabled, rectifier current limit is set in the rectifier (not via the controller) at the maximum current limit point.

- **Curr Limit Pt:** Sets the output current limit point for all rectifiers combined when the "Current Limit" setting above is set to enabled.
- **Walk-In:** Enables or disables the start-up walk-in feature for all rectifiers.
- **Walk-In Time:** Sets the start-up walk-in time when the "Walk-In" setting above is set to enabled.
- **Start Interval:** Sets the sequence start interval (time period between starting each rectifier in the system).
- **Rect Upgrade:** Not Available.
- **Normal Update:** Not Available.

### 4.1.5 Batt Settings Sub-Menu

- **Float Voltage:** Float charge output voltage setting for rectifiers.
- **EQ Voltage:** Equalize charge output voltage setting for rectifiers.
- **Num Batt Shunts:** Sets the number of battery shunts in the system.
- **Reset Batt Cap:** Resets the battery capacity calculation. The only selection is Yes. Once Yes is selected and confirmed, the battery capacity calculation is reset.



**NOTE!** Only reset the battery capacity when the battery is fully charged; otherwise, the battery charge status may not be accurate.

- **TempComp Sensor:** Select "None" for no temperature compensation or the temperature probe sensing battery temperature for temperature compensation. Options are System Temp1, System Temp2, System Temp3, SMTemp1 Temp1, ..., SMTemp1 Temp8, SMTemp8 Temp1, ..., SMTemp8 Temp8. You can also select Maximum or Average which takes the maximum or average reading of the temperature probes [any of System Temp1, System Temp2, System Temp3, SMTemp1 Temp1, ..., SMTemp1 Temp8, SMTemp8 Temp1, ..., SMTemp8 Temp8] set as battery temperature probes.



**NOTE!** The temperature compensation sensor is also the sensor which displays the battery temperature on the Web Interface's Homepage.

- **TempComp Center:** Sets the temperature at which the system operates at normal voltage levels.
- **Temp Comp Coeff:** Sets the temperature compensation slope or rate of change per °C above or below the "TempComp Center" setting. This value is expressed in millivolt per °C per string (mV/°C/str). For example, for a rate of change of 72 mV/°C/str in a 24-cell 48V nominal battery string, the rate of change is 3 mV per cell.
- **Curr Limit Mode:** Selects the current limit mode (Yes or No).
- **Batt Curr Limit:** Maximum battery charging current setting. For example, a value of 0.150C10 means that the charging current is limited to 15% of the battery's nominal capacity.
- **Over Curr Lmt:** Battery over current alarm setting. For example, a value of 0.300C10 means that when the charging current reaches 30% of the battery's nominal capacity, an alarm will be extended.
- **Auto EQ:** Enables or disables the Automatic Equalize Charge feature. **The following parameters need to be set via the Web Interface.**

**EQ Start Curr:** The system is transferred to Equalize Charge mode when battery charge current increases to this setting. For example, a value of 0.060C10 means that an Automatic Equalize is started if the battery charge current is greater than 6% of the battery's nominal capacity.

**EQ Start Cap:** The system is transferred to Equalize Charge mode when remaining battery capacity decreases to this setting.

**EQ Stop Curr:** When in Equalize Charge mode and the battery charge current decreases below this setting for the "EQ Stop Delay" time period, the system is transferred to Float Charge mode. For example, a value of 0.010C10 means that when the charging current is less than 1% of the battery's nominal capacity, the system returns to the Float mode.

**EQ Stop Delay:** See "EQ Stop Curr" above.



**NOTE!** If the power system has been automatically placed in Equalize mode, disabling Auto EQ will **not** return the system to Float mode until the current Equalize cycle is completed. To return immediately to Float mode, navigate as follows: Main Menu / Settings Icon / Maintenance / "EQ/FLT Control", and select Float Charge.

**Maximum EQ Time:** This is the maximum duration, in minutes, that an Automatic Equalize Charge will last regardless of the other settings.

**Cyc EQ:** Enables or disables cyclic (scheduled) Equalize charging. When enabled, the following parameters can be set.

**Cyc EQ Interval:** Cyclic (scheduled) Equalize charging interval.

**Cyc EQ Duration:** Cyclic (scheduled) Equalize charging duration.

- **Test Volt Level:** System output voltage setting during a battery discharge test.

- **End Test Volt:** This is the “end of test voltage level” for battery discharge tests. A battery discharge test will end if battery voltage decreases to this setting.
- **End Test Time:** This is the “end of test time period” for battery discharge tests. A battery discharge test will end if this time period is exceeded.
- **EndTestCapacity:** This is the “end of test remaining battery capacity” for battery discharge tests. A battery discharge test will end if remaining battery capacity decreases to this setting. For example, a value of 0.700C10 means that when the discharging current reaches 70% of the battery’s nominal capacity, the battery test is ended.
- **RecordThreshold:** Every time the battery voltage is changed more than this threshold, a new line is stored in the battery test log.

#### 4.1.6 Batt1 Setting Sub-Menu

- **Shunt Current:** Enter the battery string’s shunt current rating.
- **Shunt Voltage:** Enter the battery string’s shunt voltage rating.
- **Rated Capacity:** Enter the battery string’s rated capacity. After setting the battery capacity, the User should also reset the battery capacity (battery must be fully charged). See “Setting Battery Capacity Parameters” on page 31.

#### 4.1.7 Batt2 Setting Sub-Menu

- **Shunt Current:** Enter the battery string shunt’s current rating.
- **Shunt Voltage:** Enter the battery string shunt’s voltage rating.
- **Rated Capacity:** Enter the battery string’s rated capacity. After setting the battery capacity, the User should also reset the battery capacity (battery must be fully charged). See “Setting Battery Capacity Parameters” on page 31.

#### 4.1.8 LVD Settings Sub-Menu

- **HTD Point:** Sets high temperature limit at which LVD1 and/or LVD2 contactors will open (disconnect) if the HTD1 and/or HTD2 features are enabled. If this temperature is reached, a disconnect occurs regardless of voltage.
- **HTD Recon Point:** Sets temperature at which a reconnect will occur following a High Temperature Disconnect.
- **LVD 1:** Enables or disables LVD1.
- **LVD 1 Mode:** Sets LVD1 to disconnect on a voltage or time setpoint.
- **LVD 1 Disc Volt:** LVD1 low voltage disconnect setting (when LVD set for voltage).
- **LVD1 Recon Volt:** LVD1 reconnect setting (when LVD set for voltage).
- **LVD 1 Time:** The time period before LVD1 disconnection once an AC fail condition occurs (when LVD set for time).
- **LVD 1 HTD:** Enables or disables the High Temperature 1 Disconnect feature. This feature causes LVD1 contactors to open (disconnect) if a high temperature event occurs.
- **LVD 2:** Enables or disables LVD2.
- **LVD 2 Mode:** Sets LVD2 to disconnect on a voltage or time setpoint.
- **LVD 2 Disc Volt:** LVD2 low voltage disconnect setting (when LVD set for voltage).
- **LVD 2 Recon Volt:** LVD2 reconnect setting (when LVD set for voltage).



- **LVD 2 Time:** The time period before LVD2 disconnection once an AC fail condition occurs (when LVD set for time).
- **LVD 2 HTD:** Enables or disables the High Temperature 2 Disconnect feature. This feature causes LVD2 contactors to open (disconnect) if a high temperature event occurs.

#### 4.1.9 AC Settings Sub-Menu

- **Nominal AC Volt:** Enter the nominal line-to-neutral voltage (single phase rectifier) or nominal line-to-line voltage (three phase rectifier).
- **Mains Fail Alm1:** Sets the Mains Fail Alarm 1 value (percent of nominal).
- **Mains Fail Alm2:** Sets the Mains Fail Alarm 2 value (percent of nominal).

**Corresponding Alarms:**

- Phase A Voltage Low 1 (Nominal Minus "Mains Fail Alarm 1 Percent of Nominal)
- Phase A Voltage Low 2 (Nominal Minus " Mains Fail Alarm 2 Percent of Nominal)
- Phase A Voltage High 1 (Nominal Plus " Mains Fail Alarm 1 Percent of Nominal)
- Phase A Voltage High 2 (Nominal Plus "V Mains Fail Alarm 2 Percent of Nominal)
- Phase A used in the example above, Phase B and Phase C are similar.

#### 4.1.10 Other Setting Sub-Menu

- **Over Voltage 1:** Sets the Over Voltage 1 alarm point.
- **Over Voltage 2:** Sets the Over Voltage 2 alarm point.
- **Under Voltage 1:** Sets the Under Voltage 1 alarm point.
- **Under Voltage 2:** Sets the Under Voltage 2 alarm point.

#### 4.1.11 Communication Sub-Menu

- **DHCP:** The DHCP function allows the controller to acquire an IP address automatically. This function can only be enabled or disabled via the local display and keypad. If this function is enabled and the acquisition of an IP address fails, an alarm is generated. If the acquisition of an IP address is successful, you need to record the IP address automatically acquired by the controller to access the controller via the Web Interface. This IP address is displayed in the IP Address field below the DHCP setting in the local display menu (Main Menu / Settings Icon / Comm Settings).
- **IP Address:** Sets the controller's IPv4 address. Enter the address in the format nnn.nnn.nnn.nnn, where  $0 \leq nnn \leq 255$ . The address must be a valid address and must not be 255.255.255.255.
- **Subnet Mask:** Sets the controller's IPv4 network netmask. Enter the address in the format nnn.nnn.nnn.nnn, where  $0 \leq nnn \leq 255$ .
- **Default Gateway:** Sets the controller's IPv4 gateway address. Enter the address in the format nnn.nnn.nnn.nnn, where  $0 \leq nnn \leq 255$ . This is the address of the gateway of the network on which the controller resides. The address must be a valid address and must not be 255.255.255.255.

#### 4.1.12 Sys Settings Sub-Menu

- **Language:** Select the language the menus are displayed in.
- **Date:** Sets the date. Refer to "Changing the Date and Time" on page 27 for a procedure to change the date.
- **Time:** Sets the time. Refer to "Changing the Date and Time" on page 27 for a procedure to change the time.
- **Keypad Voice:** Sets the keypad sound on or off.

- **Reload Config:** Restores the controller's default settings.
- **Auto Config:** Auto configures the controller for the devices connected to it.
- **Clr Alm Hist:** Clears the alarm history.

## 5 Web Interface Screens

### 5.1 Overview of Web Function

This section provides descriptions of the Web Interface Screens. Refer also to “Passwords and Privilege Levels” on page 19 and “Using the Web Interface” on page 20. For Local Display Menus, refer to “Local Display Menus” on page 80.

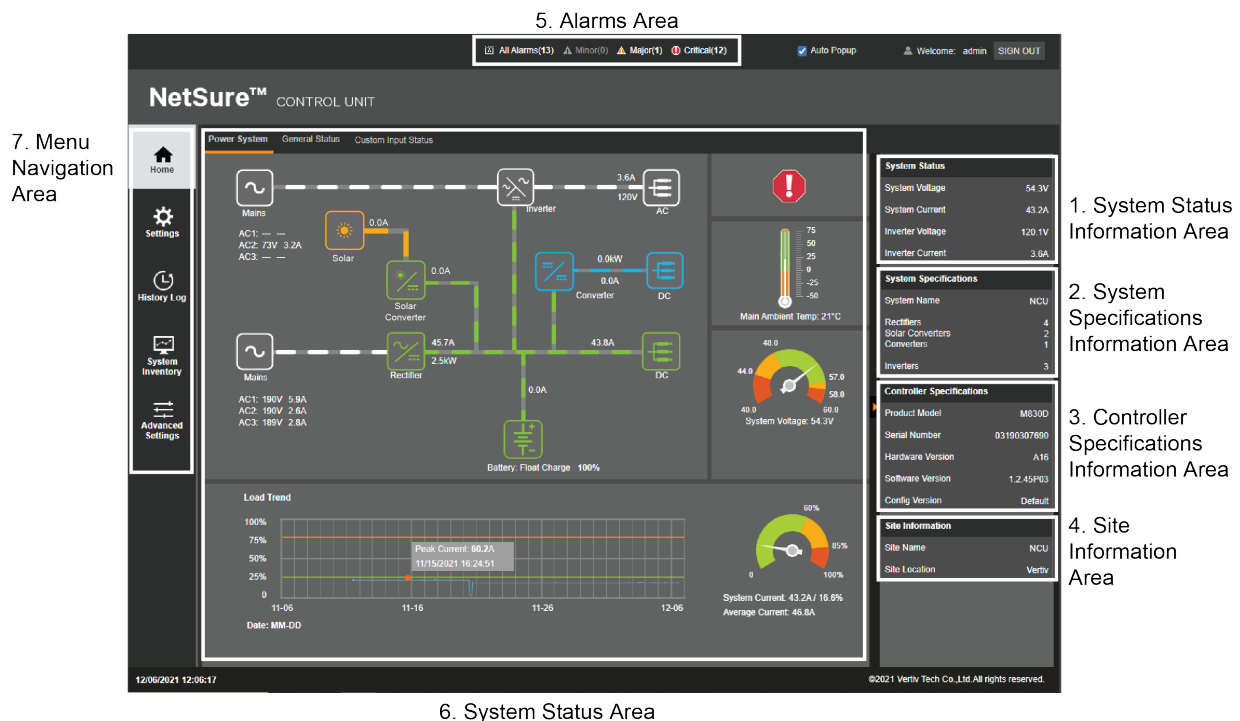


**NOTE!** Best viewed at 1024 x 768 resolution.

### 5.2 Homepage

In the Web Interface, after entering a valid **User Name** and **Password** and clicking **LOGIN**, the "Homepage" window opens. See also “Logging into the Controller” on page 21.

Figure 5.1 Sample of Homepage (with Rectifiers, Solar Converters, Converters, and Inverters Installed in System)



The homepage window is divided into the following areas:

1. System Status Information Area (see “System Status Information Area” on page 102).
2. System Specifications Information Area (see “System Specifications Information Area” on page 102).
3. Controller Specifications Information Area (see “Controller Specifications Information Area” on page 102).
4. Site Information Area (see “Site Information Area” on page 102).
5. Alarms Area (see “Alarms Area” on page 103).
6. System Status Area (see “System Status Area” on page 104).
7. Menu Navigation Area (see “Menu Navigation Area” on page 132).

### 5.3 System Status Information Area

Output voltage and output current are displayed here.

### 5.4 System Specifications Information Area

System specifications are displayed here.

### 5.5 Controller Specifications Information Area

Controller specifications are displayed here.

### 5.6 Site Information Area

Site information is displayed here.

**Figure 5.2 System Status Information, System Specifications Information, Controller Specifications Information, and Site Information Areas**

System Status	
System Voltage	54.4V
System Current	43.2A
Inverter Voltage	120.1V
Inverter Current	3.6A
System Specifications	
System Name	NCU
Rectifiers	4
Converters	1
Inverters	3
Controller Specifications	
Product Model	M830D
Serial Number	03190307690
Hardware Version	A16
Software Version	1.2.45P03
Config Version	Default
Site Information	
Site Name	NCU
Site Location	Vertiv

## 5.7 Alarms Area

Any alarms active in the power system are shown in this area.

- When viewing the Alarm List, click the “arrow” icon to collapse the Alarm List. Click the “arrow” icon again to expand the Alarm List.
- The alarms area contains tabs to allow viewing all alarms or a type of alarm (severity). For example, click the Critical tab to display alarms set as Critical alarms.
- When the “Auto Popup” box is checked and the Alarm List is collapsed, a new alarm will cause the Alarm List to expand.



**NOTE!** Minor alarms are shaded yellow, major alarms are shaded orange, and critical alarms are shaded red.

Figure 5.3 Alarms Area

Arrow Icon      Alarm Severity Tabs or All Alarms      “Auto Popup” Box

All Alarms(12)   Minor(0)   Major(0)   Critical(12)   Auto Popup

Alarm List Collapsed

Index	Alarm Level	Relative Device	Signal Name	Sample Time
1	CR	SMDU1 DC Fuse	Fuse 1 Alarm	06/13/2018 14:59:44
2	CR	SMDU1 DC Fuse	Fuse 2 Alarm	06/13/2018 14:59:44
3	CR	SMDU1 DC Fuse	Fuse 3 Alarm	06/13/2018 14:59:44
4	CR	SMDU1 DC Fuse	Fuse 4 Alarm	06/13/2018 14:59:44
5	CR	SMDU1 DC Fuse	Fuse 5 Alarm	06/13/2018 14:59:44

Alarm List Expanded

## 5.8 System Status Area

System status is displayed in this area and consists of a Power System tab (see page 104), Energy Sources tab (if additional energy sources are connected to the system) (see page 129), General Status tab (see page 130), and Custom Input Status tab (if an SM-DUE is connected to the controller and one of the inputs is being used for voltage or transducer) (see page 131).

### Temperature Reading

- The temperature sensor set as “Main Ambient Temp Sensor” (Settings Menu / System Tab) is the sensor which displays the ambient temperature on the Power System tab.

### System Current Reading

- “System Current” equals total rectifier current or total solar converter current minus total battery current when battery shunt exists or calculated battery current. If you do not calculate battery current, “System Current” equals total rectifier current or total solar converter current.

### Calculated Load Current Reading

This value changes based on equipment installed.

- If no Load Shunts, then the value is calculated same as the "System Current".
- If Load Shunts exist and Converters exist, then the value is calculated as:  
System Current - Converter Input Current
- If Load Shunts exist and no Converters, then the value is same as the "Total DC Load".

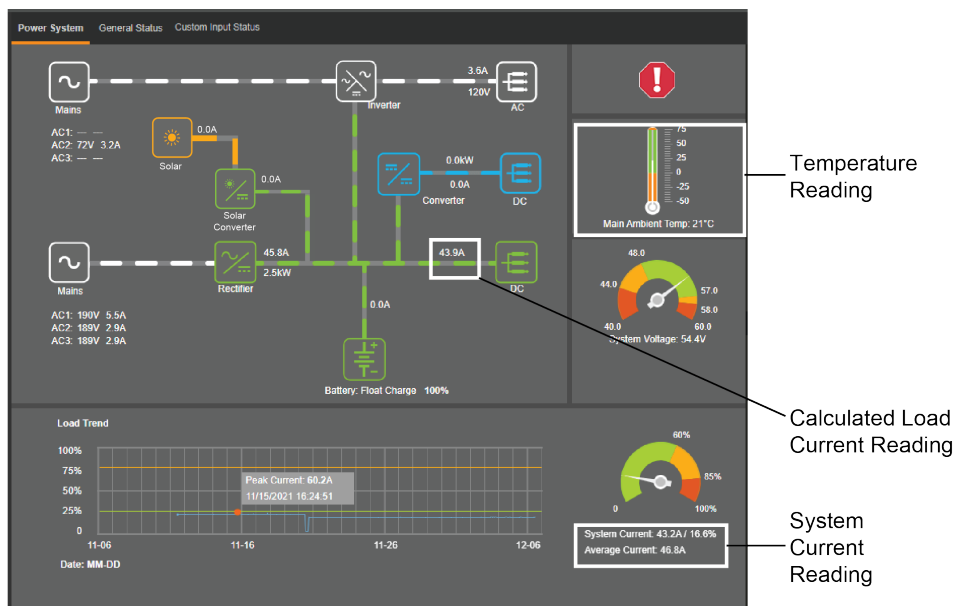
### 5.8.1 Power System Tab

The Power System tab displays power system status in a graphical block diagram format. This includes status of the input power, modules (i.e., rectifiers, solar converters, converters, inverters), DC load, AC load, and battery. Also displayed are alarm status, ambient temperature, output voltage, output current, average current, and a load trend chart.



**NOTE!** The load trend chart gets data from the “Data History Log” and will plot the MAXIMUM value per hour per day.

Figure 5.4 Sample Power System Tab (with Rectifiers, Solar Converters, Converters, and Inverters Installed in System)



**When an EIB and/or SMDU Shunt is Set as Source**

See also “Shunts Tab” on page 194.

A “source” icon appears (see Figure 5.5). Clicking on the source icon displays the currents for shunts set as “source” (see Figure 5.6).

Figure 5.5 Sample Source Icon Display

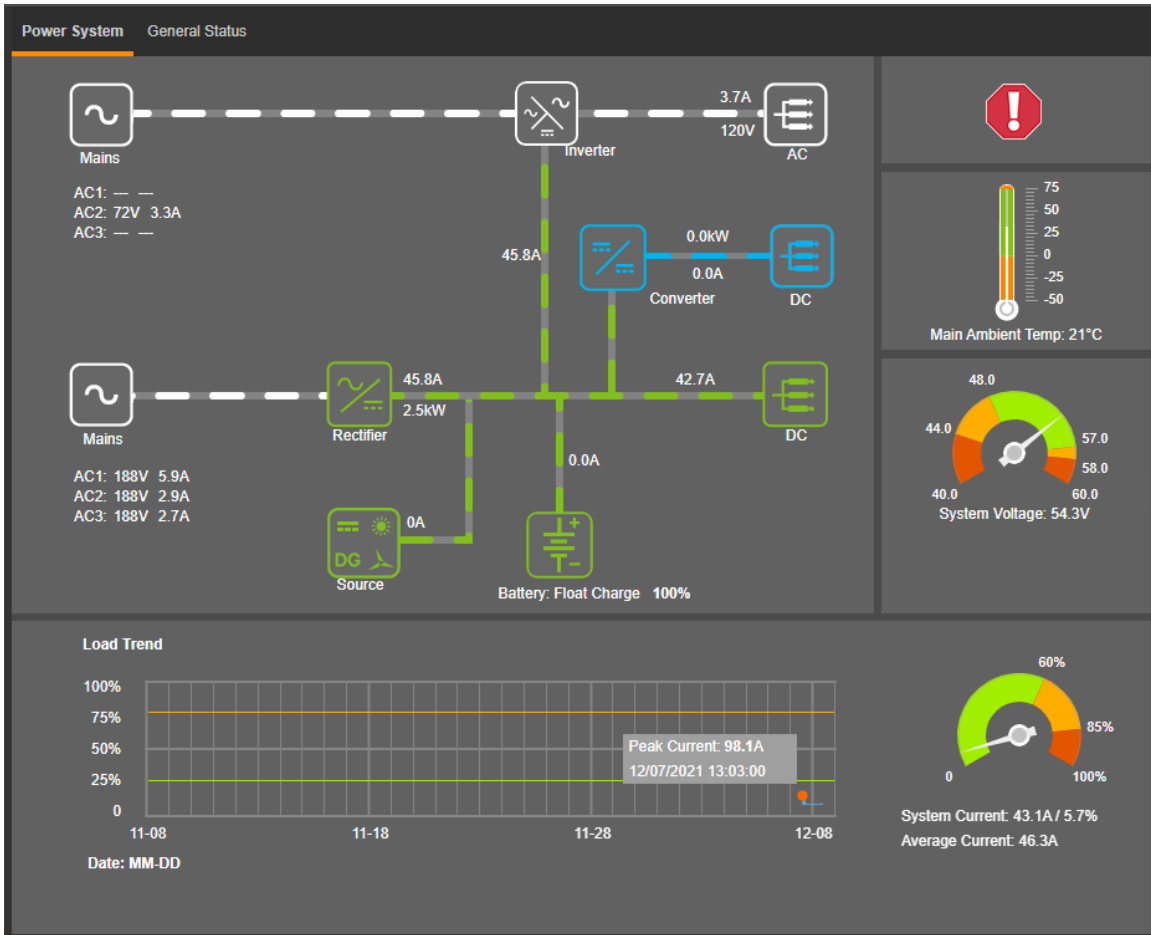


Figure 5.6 Shunts Set as “Source”

EIB			
EIB-1			
Signal	Value	Signal	Value
Source 1	0.0 A		

## Power System Status Graphical Block Diagram

The power system status area is User interactive. Clicking on the various icons will take you to specific status Web pages, as explained in the next sections.

### Rectifier Mains Icon

Clicking on the rectifier Mains icon opens the following Web page.

Figure 5.7 Rectifier Mains Status Web Page

The screenshot shows a web interface for the 'AC Unit' section, specifically for 'Rectifier AC'. It displays a table with three columns representing AC1, AC2, and AC3. The rows show Voltage (VAC) and Input Current (A) for each phase.

	AC1	AC2	AC3
Voltage (VAC)	189 V	189 V	189 V
Input Current (A)	5.8 A	2.7 A	2.9 A

### Inverter Mains Icon

Clicking on the inverter Mains icon opens the following Web page.

Figure 5.8 Inverter Mains Status Web Page

The screenshot shows a web interface for the 'AC' section, specifically for 'Inverter AC'. It displays a table with three columns representing AC1, AC2, and AC3. The rows show Voltage (VAC) and Current (A) for each phase.

	AC1	AC2	AC3
Voltage (VAC)	—	72	—
Current (A)	—	3.3	—

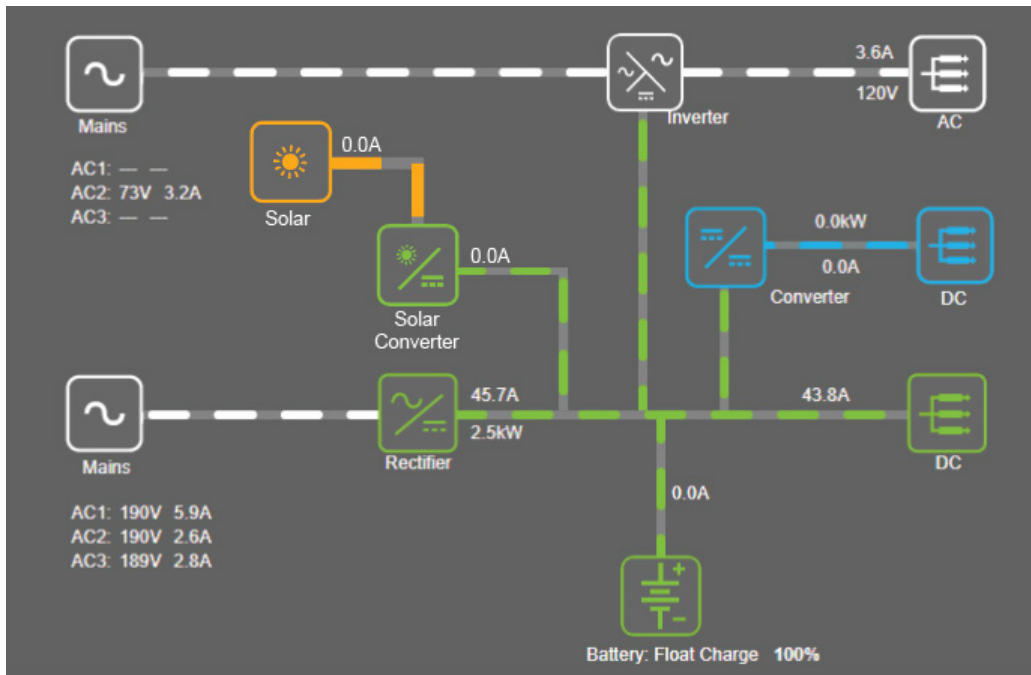


## Device Group Status Pages

The power system status block diagram has interactive links. Clicking on a link takes you to that device group's status page. A device group's status page displays current or logged operating parameters for that device group.

The following sections describe the Module (i.e., rectifier, converter, solar converter, inverter), DC, AC, and the Battery device groups as samples of how to use these links.

**Figure 5.9 Sample Power System Status Page Block Diagram (with Rectifiers, Solar Converters, Converters, and Inverters Installed in System)**



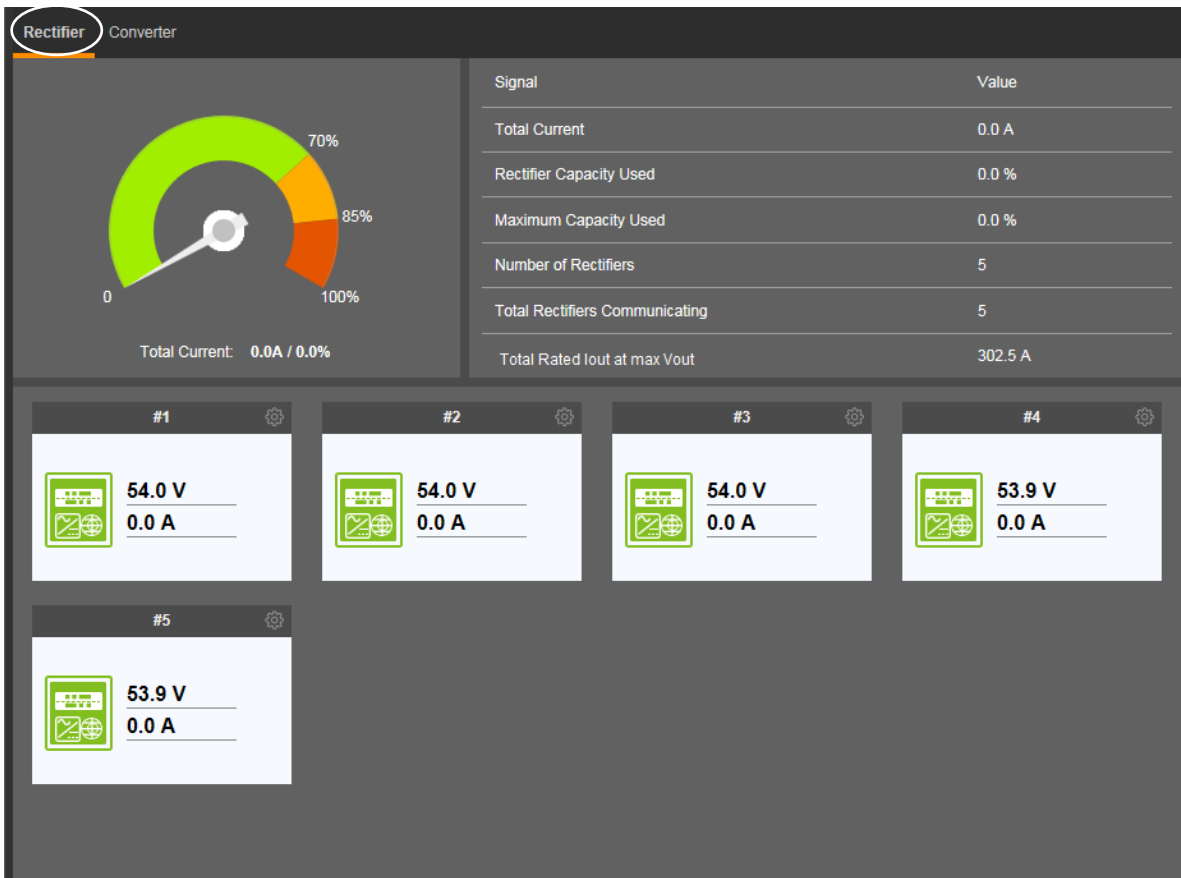
**Module (Rectifier, Converter, Solar Converter, Inverter) Device Group Status Page**

Clicking on a rectifier, converter, solar converter, or inverter icon on the power system status block diagram opens the status page for the module’s Device Group. The Module Device Group status page contains multiple tabs (depending on the modules installed in your power system). This includes Rectifier, Converter, Solar Converter, and Inverter tabs.

**Rectifier Device Group Status Page Tab**

This tab displays status values such as “Total Current”, “Number of Rectifiers”, etc.

Figure 5.10 Rectifier Device Group Status Page Tab



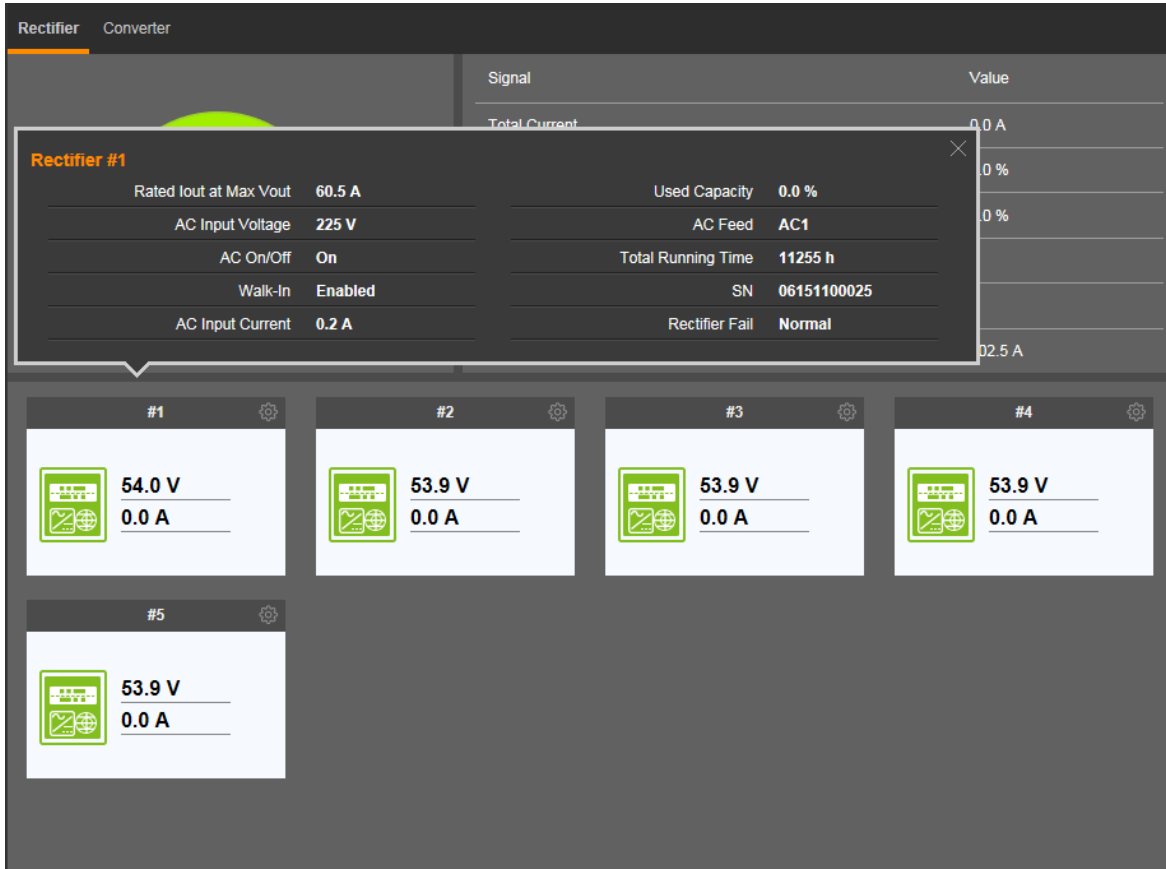
**NOTE!** The “Rectifier Capacity Used” and load percentage indicators are based on the nominal ratings under nominal operating conditions

**NOTE!** “Rectifier Capacity Used” and “Maximum Used Capacity” are based on 54 VDC.

### Individual Rectifier Status Page

Displayed on the Rectifier Device Group status page are the individual rectifiers installed in the system. Click on an individual rectifier icon to display its status such as "Valid Rated Current", etc.

Figure 5.11 Individual Rectifier Status Page



### Individual Rectifier Settings Page


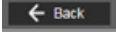
In the Rectifier Device Group Status Page Tab, click the settings wheel icon  to go to the individual rectifier settings page. Click  to go back to the Rectifier Device Group Status Page Tab.

Figure 5.12 Selecting an Individual Rectifier Settings Page

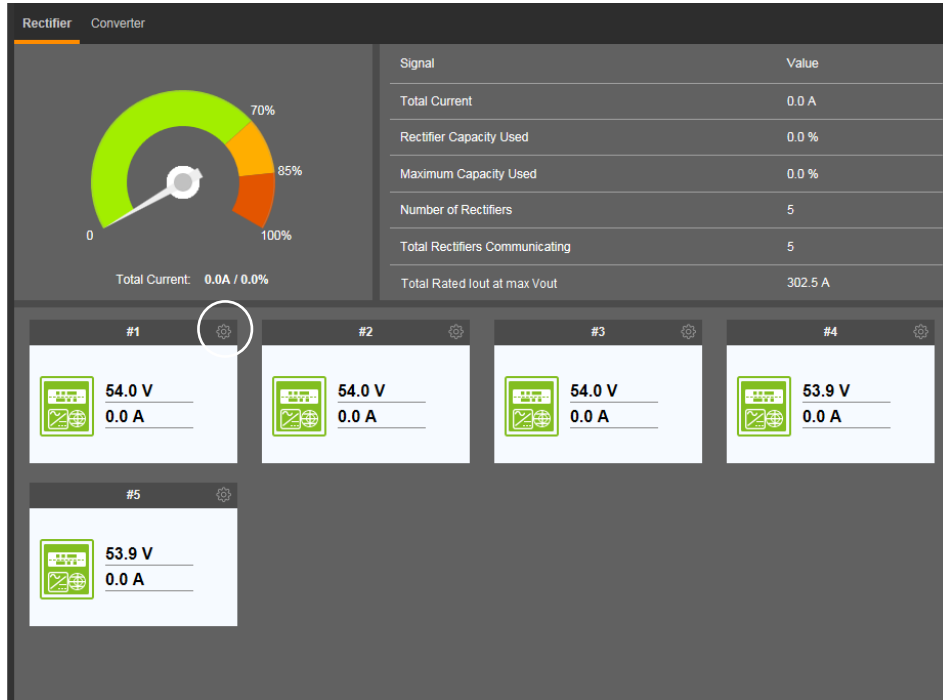
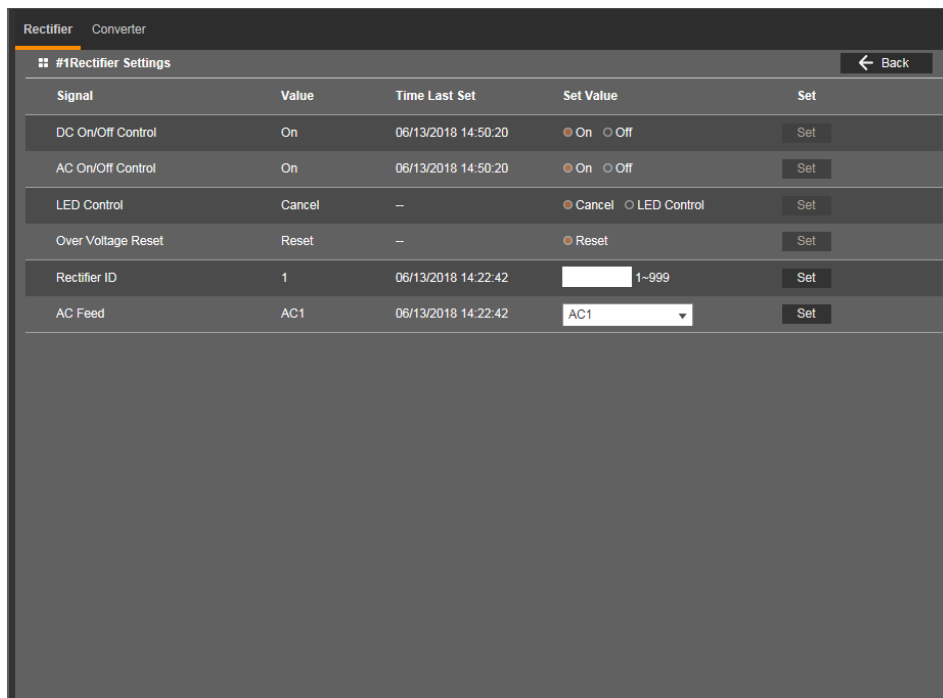


Figure 5.13 Individual Rectifier Settings Page





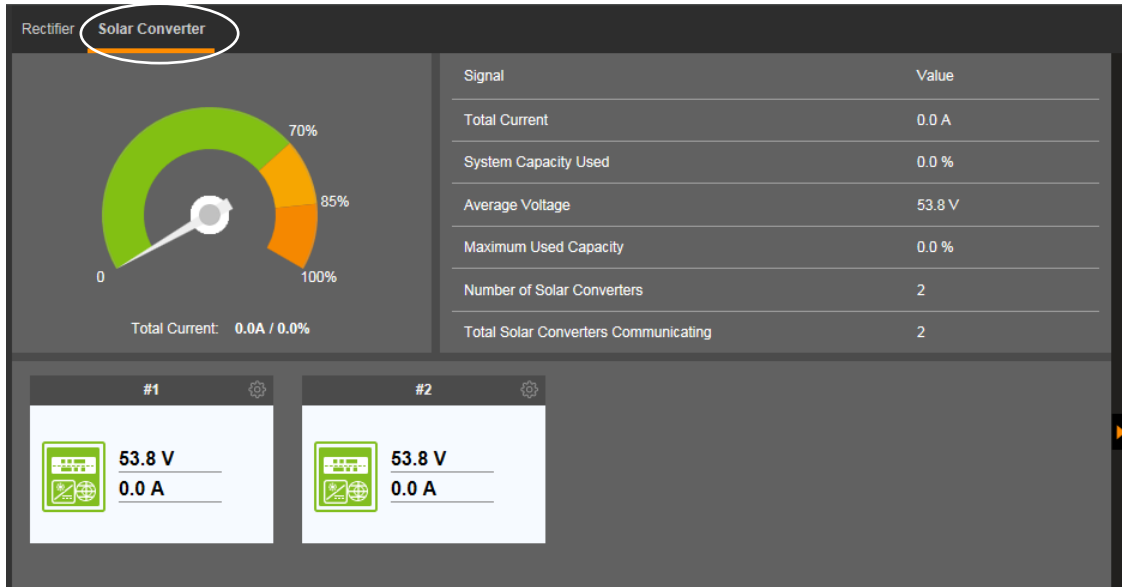
**NOTE!** Settings that appear "grayed out" can only be made when the controller is in the "manual control" state. If the controller is set for "automatic" control, change the "Auto/Manual State" setting first to the "Manual" setting.

- **DC On/Off Control:** Temporarily turns the rectifier's DC output on or off when the controller is in Manual mode. Setting returns to original when controller is returned to the Auto mode.
- **AC On/Off Control:** Temporarily turns the rectifier's AC input on or off when the controller is in Manual mode. Setting returns to original when controller is returned to the Auto mode.
- **LED Control:** Temporarily sets whether or not the rectifier's local power indicator blinks when the controller is communicating with the rectifier when the controller is in Manual mode. Setting returns to original when controller is returned to the Auto mode.
- **Over Voltage Reset:** Temporarily sets the rectifier's over voltage reset feature when the controller is in Manual mode. Setting returns to original when controller is returned to the Auto mode.
- **Rectifier ID:** Sets the rectifier's identification number.
- **AC Feed:** Indicates the phase connected to the rectifier's input.

### Solar Converter Device Group Status Page Tab

This tab displays status values such as “Total Current”, “Number of Solar Converters”, etc.

Figure 5.14 Solar Converter Device Group Status Page Tab

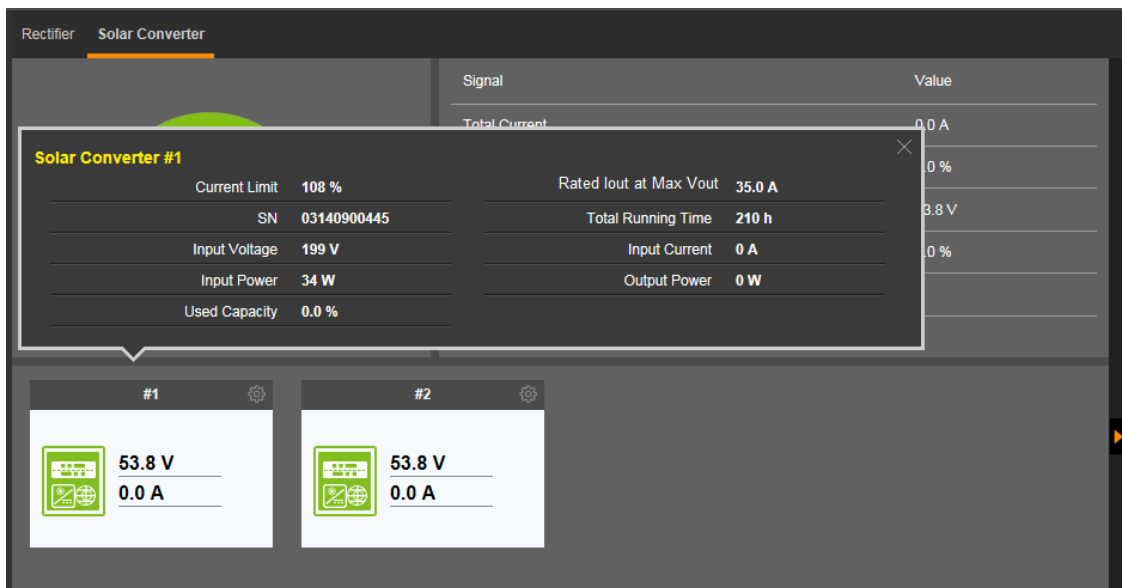


**NOTE!** “System Capacity Used” and “Maximum Used Capacity” are based on 54 VDC.

### Individual Solar Converter Status Page

Displayed on the Solar Converter Device Group status page are the individual solar converters installed in the system. Click on an individual solar converter icon to display its status such as “Input Current”, “Output Power”, etc.

Figure 5.15 Individual Solar Converter Status Page



### Individual Solar Converter Settings Page


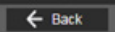
In the Solar Converter Device Group Status Page Tab, click the settings wheel icon  to go to the individual solar converter settings page. Click  to go back to the Solar Converter Device Group Status Page Tab.

Figure 5.16 Selecting an Individual Solar Converter Settings Page

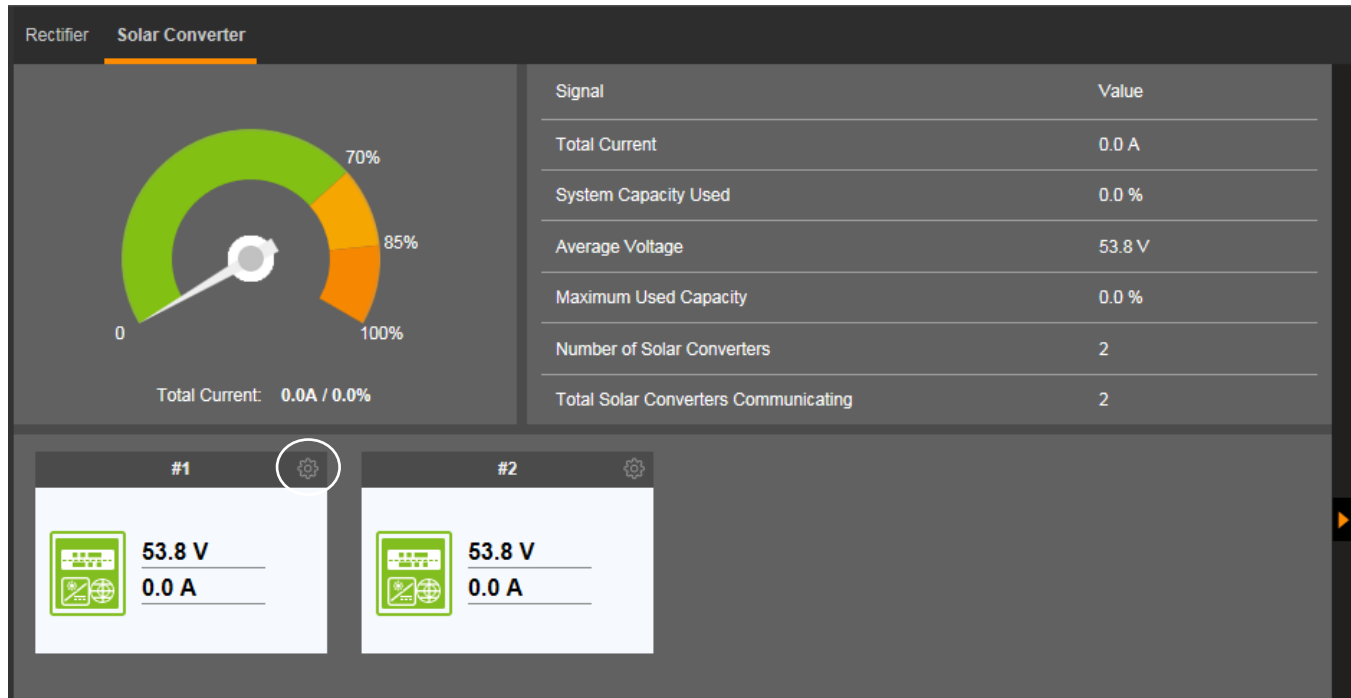
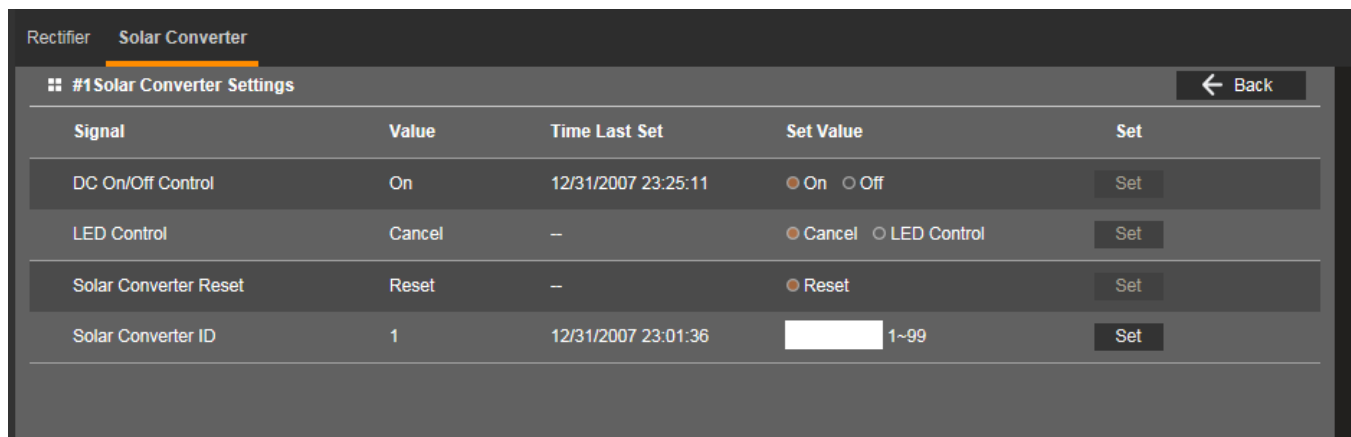



Figure 5.17 Individual Solar Converter Settings Page



 **NOTE!** Settings that appear "grayed out" can only be made when the controller is in the "manual control" state. If the controller is set for "automatic" control, change the "Auto/Manual State" setting first to the "Manual" setting.

- **DC On/Off Control:** Temporarily turns the solar converter's DC output on or off when the controller is in Manual mode. Setting returns to original when controller is returned to the Auto mode.

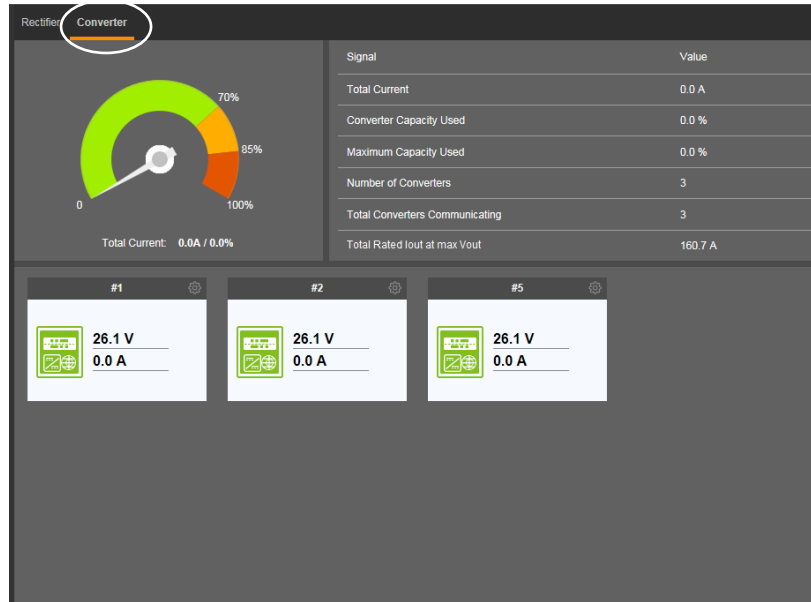
- **LED Control:** Temporarily sets whether or not a solar converter's local power indicator blinks when the controller is communicating with the solar converter when the controller is in Manual mode. Setting returns to original when controller is returned to the Auto mode.
- **Solar Converter Reset:** Temporarily sets the solar converter's over voltage reset feature when the controller is in Manual mode. Setting returns to original when controller is returned to the Auto mode.
- **Solar Converter ID:** Sets the solar converter's identification number.



### Converter Device Group Status Page Tab

This tab displays status values such as “Total Current”, “Number of Converters”, etc.

Figure 5.18 Converter Device Group Status Page Tab

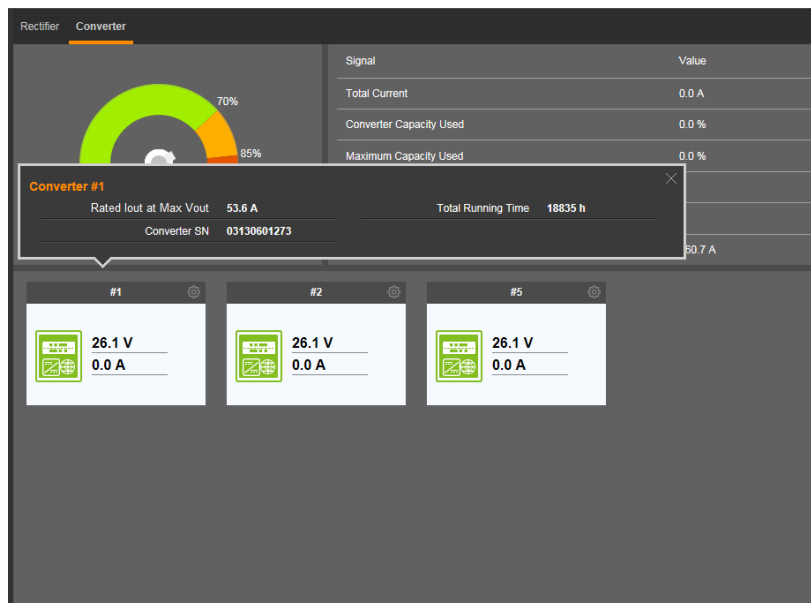


**NOTE!** “Converter Capacity Used” and “Maximum Capacity Used” are based on 26 VDC.

### Individual Converter Status Page

Displayed on the Converter Device Group status page are the individual converters installed in the system. Click on an individual converter icon to display its status such as “Current”, etc.

Figure 5.19 Individual Converter Status Page



### Individual Converter Settings Page


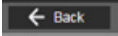
In the Converter Device Group Status Page Tab, click the settings wheel icon  to go to the individual converter settings page. Click  to go back to the Converter Device Group Status Page Tab.

Figure 5.20 Selecting an Individual Converter Settings Page

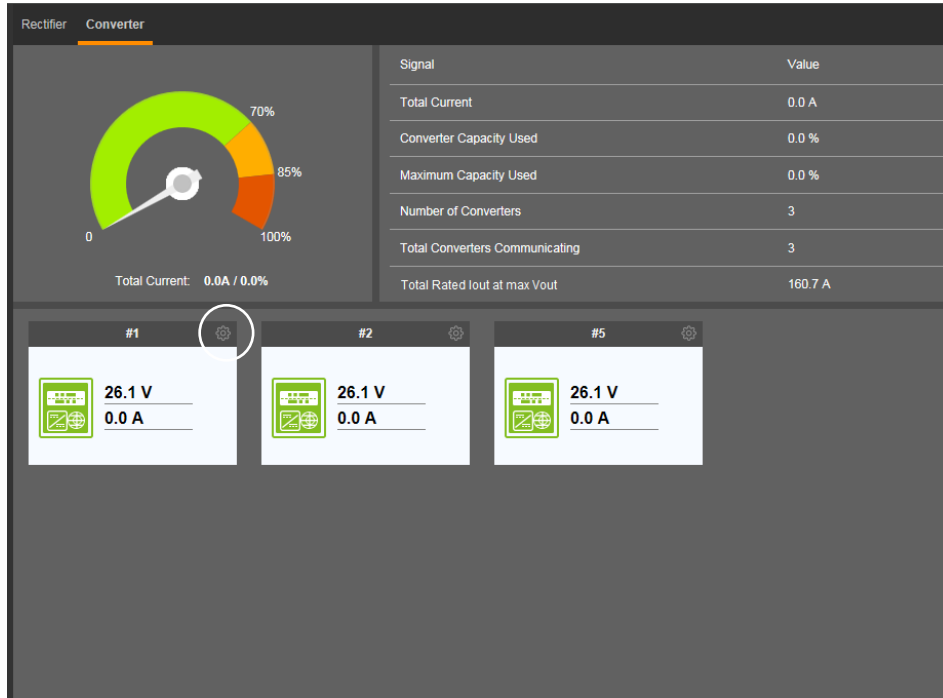
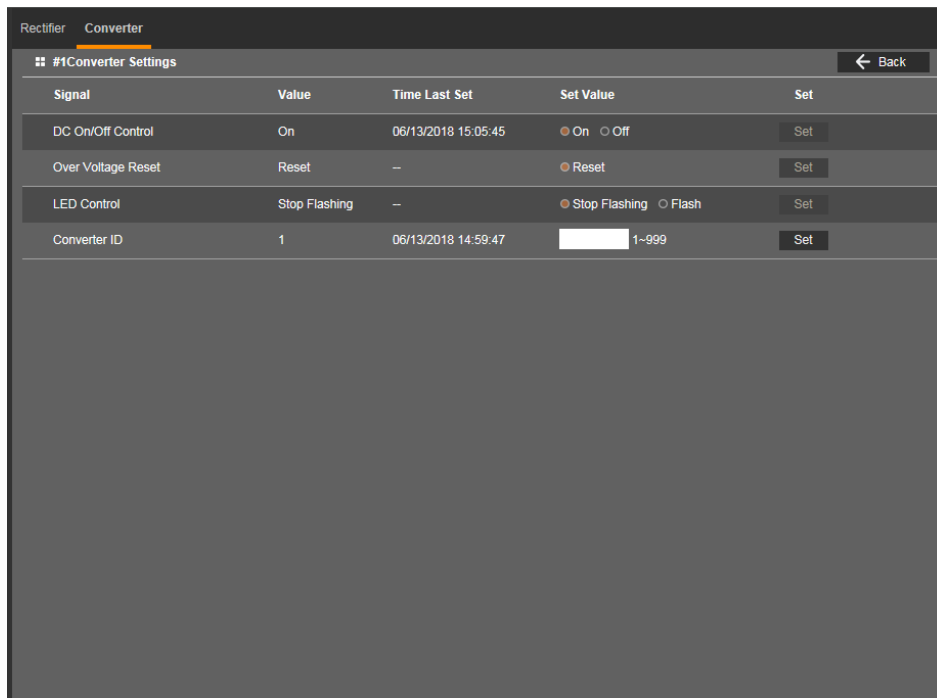


Figure 5.21 Individual Converter Settings Page





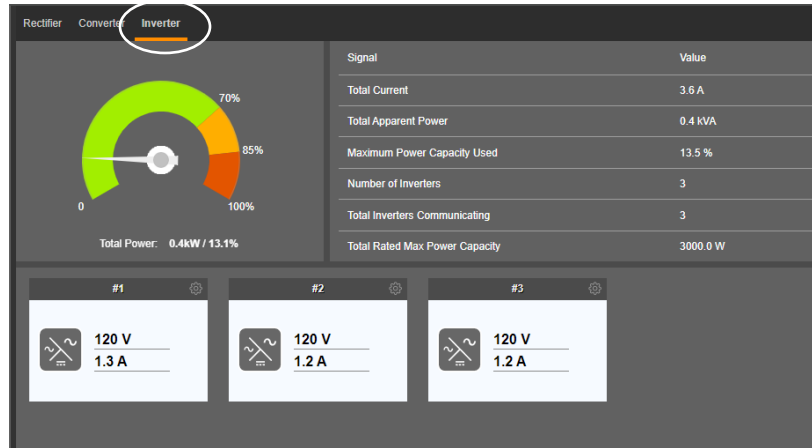
**NOTE!** Settings that appear "grayed out" can only be made when the controller is in the "manual control" state. If the controller is set for "automatic" control, change the "Auto/Manual State" setting first to the "Manual" setting.

- **DC On/Off Control:** Temporarily turns the converter's DC output on or off when the controller is in Manual mode. Setting returns to original when controller is returned to the Auto mode.
- **Over Voltage Reset:** Temporarily sets the converter's over voltage reset feature when the controller is in Manual mode. Setting returns to original when controller is returned to the Auto mode.
- **LED Control:** Temporarily sets whether or not a converter's local power indicator blinks when the controller is communicating with the converter when the controller is in Manual mode. Setting returns to original when controller is returned to the Auto mode.
- **Converter ID:** Sets the converter's identification number.

### Inverter Device Group Status Page Tab

This tab displays status values such as “Total Current”, “Number of Inverters”, etc.

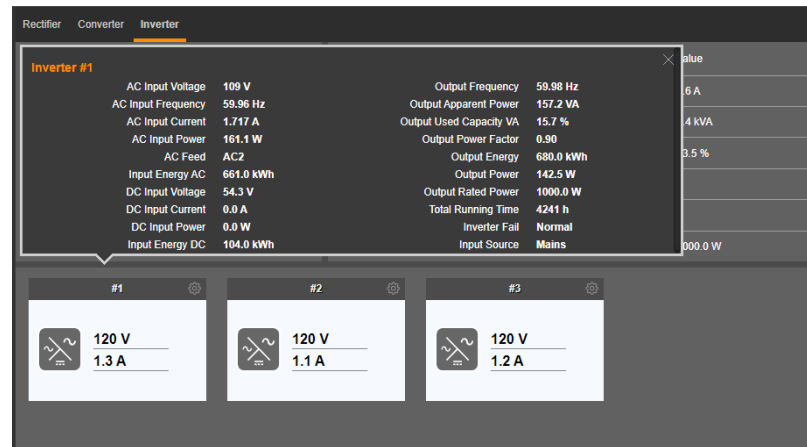
Figure 5.22 Inverter Device Group Status Page Tab



### Individual Inverter Status Page

Displayed on the Inverter Device Group status page are the individual inverters installed in the system. Click on an individual inverter icon to display its status such as "Output Power", etc.

Figure 5.23 Individual Inverter Status Page



### Individual Inverter Settings Page


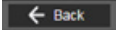
In the Inverter Device Group Status Page Tab, click the settings wheel icon  to go to the individual inverter settings page. Click  to go back to the Inverter Device Group Status Page Tab.

Figure 5.24 Selecting an Individual Inverter Settings Page

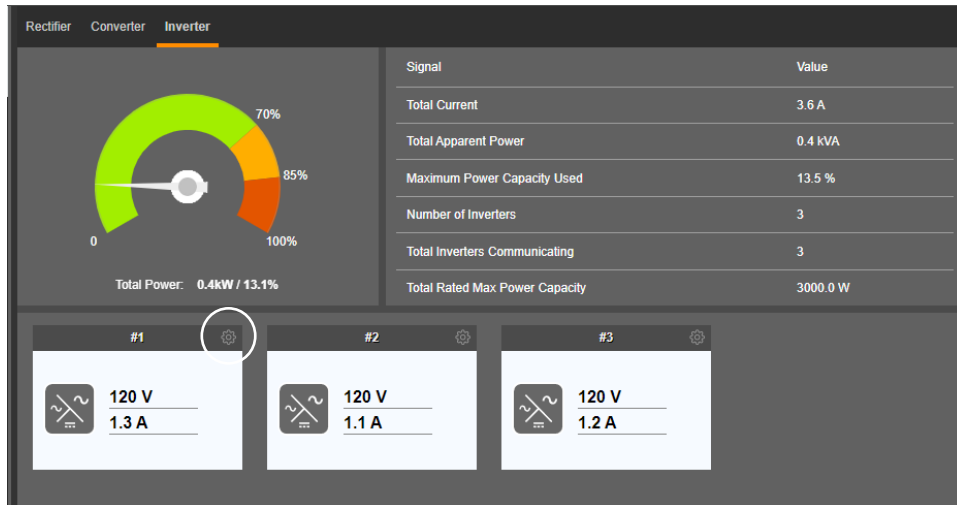
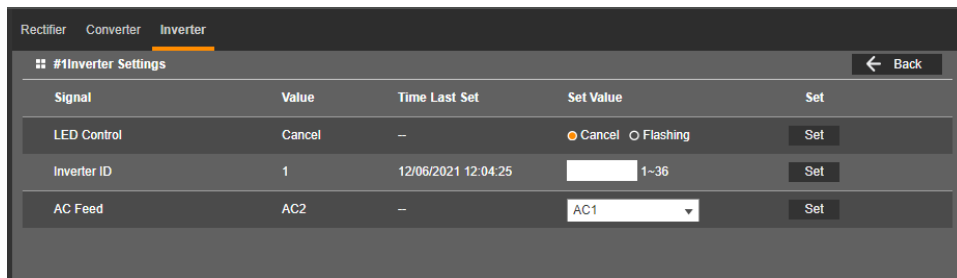


Figure 5.25 Individual Inverter Settings Page



**NOTE!** Settings that appear "grayed out" can only be made when the controller is in the "manual control" state. If the controller is set for "automatic" control, change the "Auto/Manual State" setting first to the "Manual" setting.

- **LED Control:** Temporarily sets whether or not an inverter's local power indicator blinks when the controller is communicating with the inverter when the controller is in Manual mode. Setting returns to original when controller is returned to the Auto mode.
- **Inverter ID:** Sets the inverter's identification number.
- **AC Feed:** Indicates the phase connected to the inverter's input.

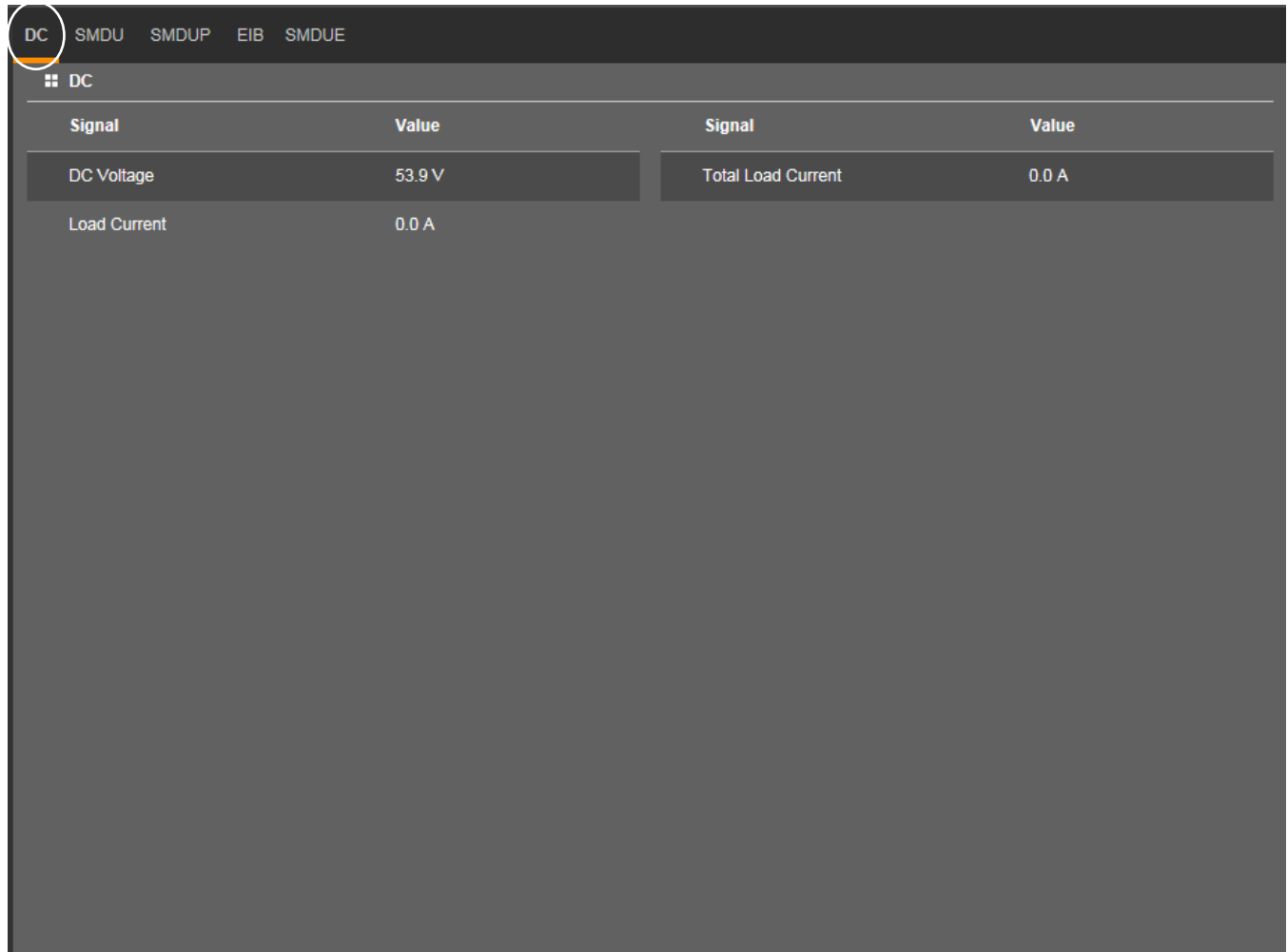
### DC Device Group Status Page

Clicking on the DC icon on the power system status block diagram opens the status page for the DC Device Group. The DC Device Group status page contains multiple tabs (depending on the DC equipment installed in your power system). This includes DC, SMDU, SMDUP, EIB, and SMDUE. The DC status page tab is shown next for an example.

### DC Status Tab

This tab displays status values such as "DC Voltage" and "Total Load Current".

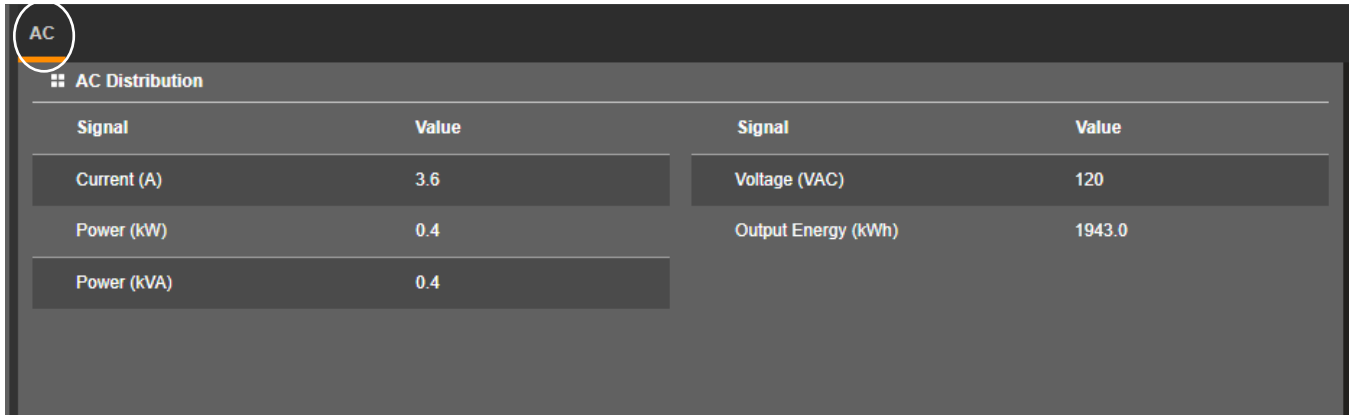
Figure 5.26 DC Device Group Status Tab



### AC Device Group Status Page

Clicking on the AC icon on the power system status block diagram opens the status page for the AC Device Group. This status page displays status values such as "Current (A)" and "Voltage (VAC)".

Figure 5.27 AC Device Group Status Page



The screenshot shows the AC Device Group Status Page. At the top left, there is a circular icon with the letters "AC" inside. Below the icon is a header "AC Distribution" with a small square icon to its left. The main content is a table with two columns of data. The first column lists signals and their values, and the second column lists signals and their values.

Signal	Value	Signal	Value
Current (A)	3.6	Voltage (VAC)	120
Power (kW)	0.4	Output Energy (kWh)	1943.0
Power (kVA)	0.4		

### Battery Device Group Status Page

Clicking on the battery icon on the power system status block diagram opens the status page for the Battery Device Group. The Battery Device Group status page displays battery status values such as "Battery Management State" and "Battery Temp". The actual display of the Battery Device Group status page is dependent on the controller configuration and if SMDU or EIB shunts are programmed as battery shunts (see Figure 5.28 and Figure 5.29 for samples). If Lithium-Ion Battery(s) are connected and communicating via RS485, the BMS Battery Icon will appear and clicking on the icon will display status values such as Battery Current, SOC, Cycle Count, and Date of Manufacturing.

Figure 5.28 Sample Battery Device Group Status Page

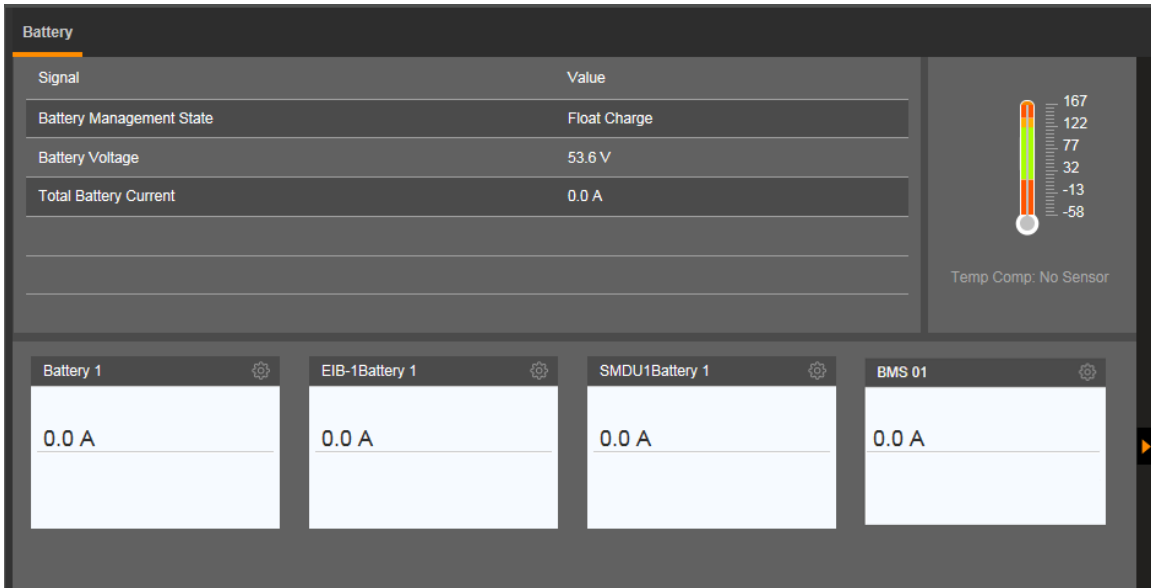
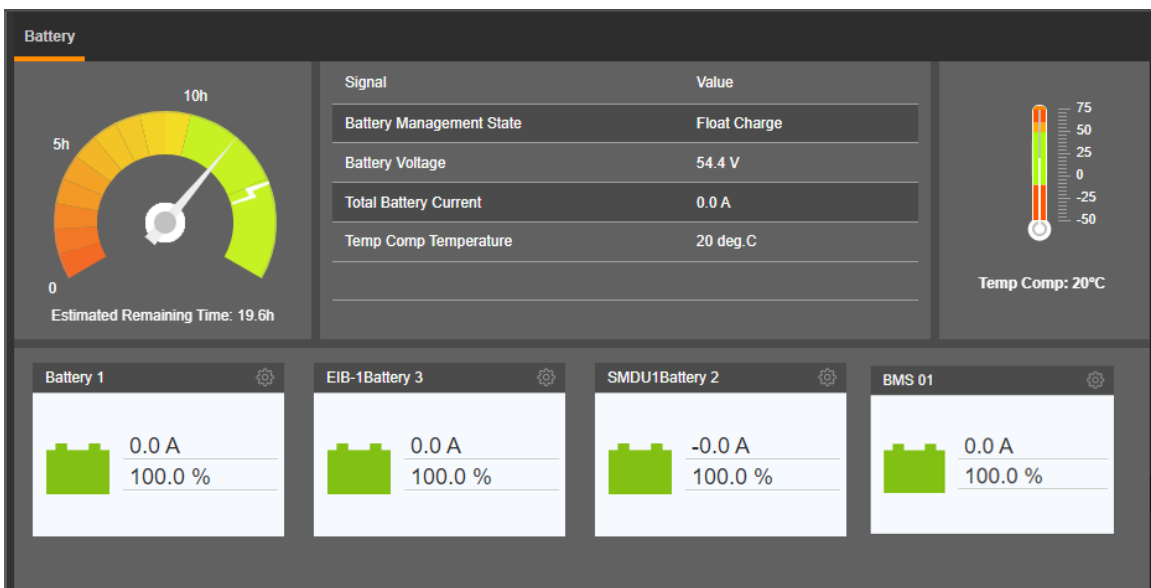


Figure 5.29 Sample Battery Device Group Status Page





### Individual Battery Status Page

Displayed on the Battery Device Group status page are the individual batteries installed in the system. Hover the mouse over an individual battery icon to display its status such as "Battery Remaining (Ah)". The actual display of an Individual Battery status page is dependent on the controller configuration and if SMDU or EIB shunts are programmed as battery shunts (see Figure 5.30, Figure 5.31, and Figure 5.32 for samples). If Lithium-Ion Battery(s) are connected and communicating via RS485, the BMS Battery Icon will appear and clicking on the icon will display status values such as Battery Current, SOC, Cycle Count, and Date of Manufacturing.

Figure 5.30 Sample Individual Battery Status Page

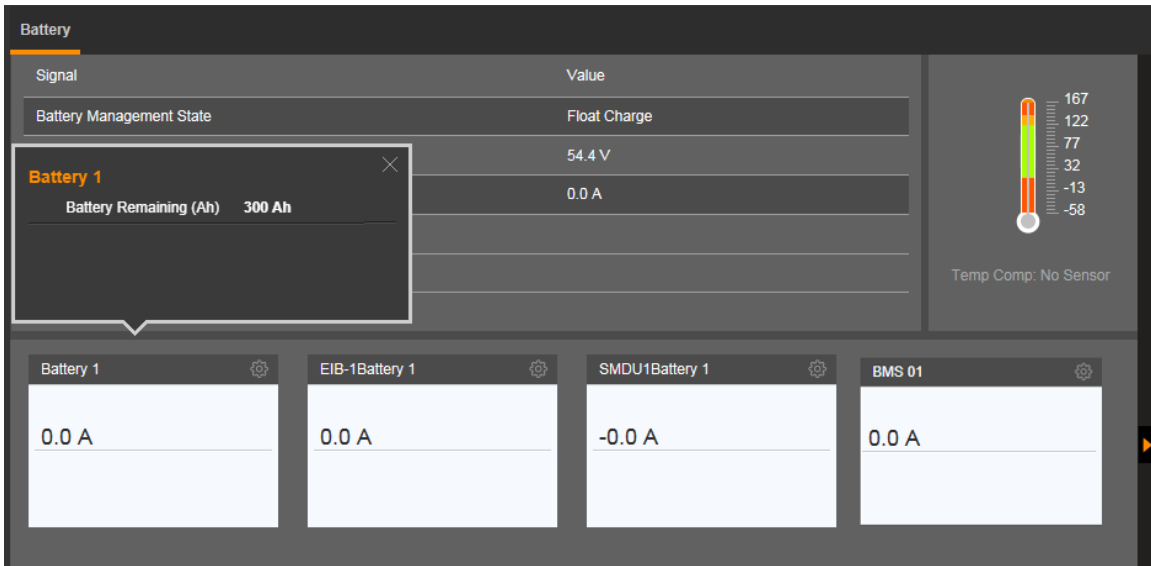


Figure 5.31 Sample Individual Battery Status Page

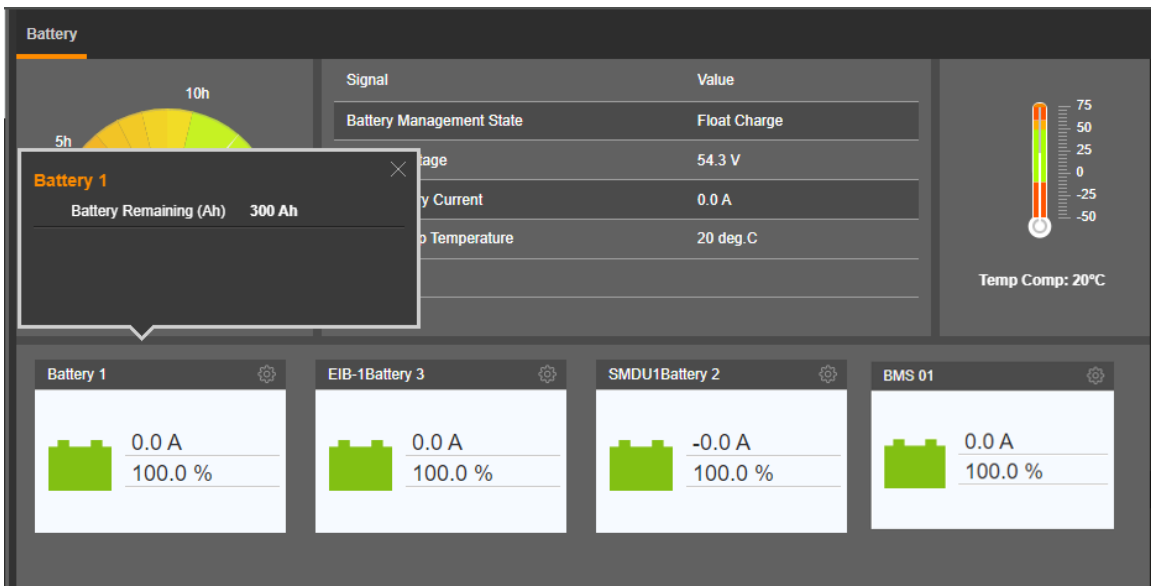


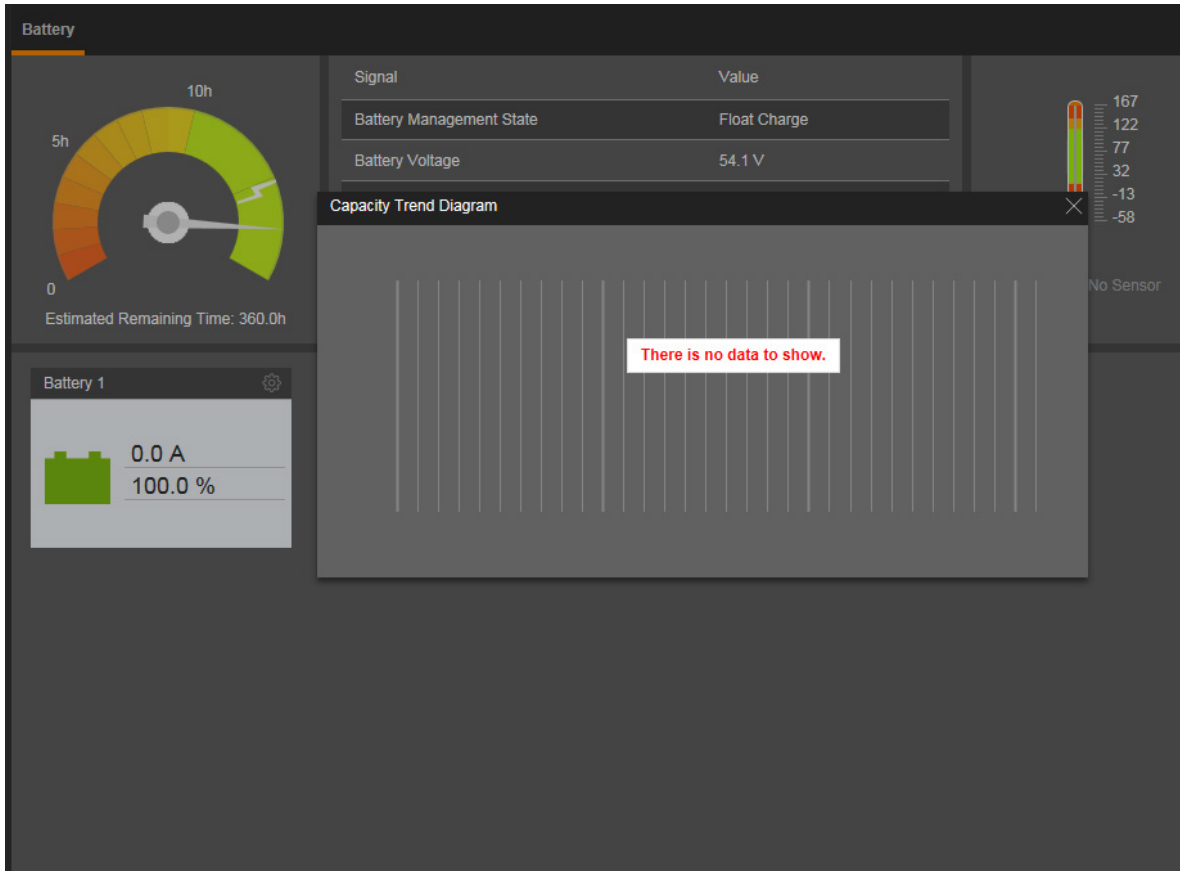
Figure 5.32 Sample Individual Battery Status Page




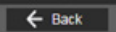
### Individual Battery Capacity Trend Diagram or Info Screen

Displayed on the Battery Device Group status page are the individual batteries installed in the system. Click on an individual battery (Battery 1) to display its "Capacity Trend Diagram" or "info screen". The actual display of an individual battery capacity trend diagram or info screen is dependent on the controller configuration. See Figure 5.33 for sample).

Figure 5.33 Sample Individual Battery Capacity Trend Diagram



### Individual Battery Settings Page

In the Battery Device Group Status Page Tab, click the settings wheel icon  to go to the individual battery settings page. See Figure 5.34. Click  to go back to the Battery Device Group Status Page Tab. The actual display of an Individual Battery status is dependent on the controller configuration and if SMDU or EIB shunts are programmed as battery shunts (see Figure 5.35, Figure 5.36, and Figure 5.37.) If Lithium-Ion Battery(s) are connected and communicating via RS485, the BMS Battery Icon will appear and clicking on the icon will display status values such as Battery Current, SOC, Cycle Count, and Date of Manufacturing.

Note that FIAMM SoNick (Sodium Nickel) Battery parameters cannot be changed.

Figure 5.34 Selecting an Individual Battery Settings Page

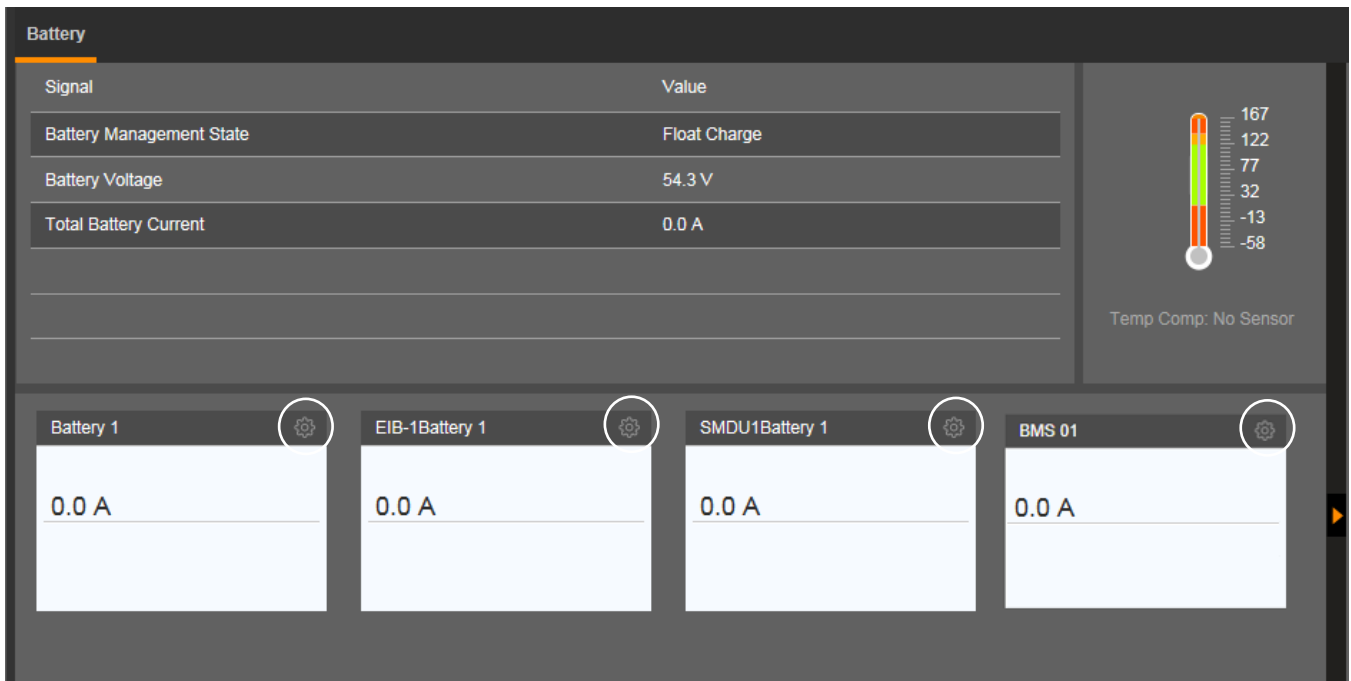


Figure 5.35 Individual Battery Settings Page (Battery #)

Battery				
Battery 1 <span style="float: right;">← Back</span>				
Signal	Value	Time Last Set	Set Value	Set
Battery Management	Yes	–	<input checked="" type="radio"/> Yes <input type="radio"/> No	<input type="button" value="Set"/>
Rated Capacity	50 Ah	05/29/2018 09:58:51	<input type="text" value=""/> 10~50000	<input type="button" value="Set"/>

Figure 5.36 Individual Battery Settings Page (SMDU#Battery #)

Battery				
SMDU1Battery 1 <span style="float: right;">← Back</span>				
Signal	Value	Time Last Set	Set Value	Set
Battery Management	Yes	–	<input checked="" type="radio"/> Yes <input type="radio"/> No	<input type="button" value="Set"/>
Rated Capacity	300 Ah	–	<input type="text" value=""/> 10~50000	<input type="button" value="Set"/>

Figure 5.37 Individual Battery Settings Page (EIB-#Battery #)

Battery				
EIB-1Battery 1 <span style="float: right;">← Back</span>				
Signal	Value	Time Last Set	Set Value	Set
Battery Management	Yes	–	<input checked="" type="radio"/> Yes <input type="radio"/> No	<input type="button" value="Set"/>
Rated Capacity	300 Ah	–	<input type="text" value=""/> 10~50000	<input type="button" value="Set"/>

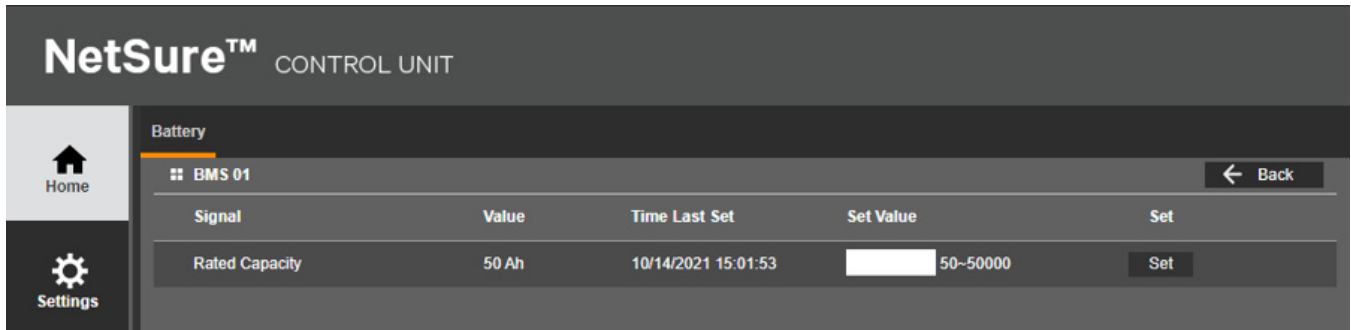
- **Battery Management:** Select Yes to use the battery management feature and No to not use the feature for this battery.
- **Rated Capacity:** Enter the battery string's rated capacity.



**NOTE!** The "Rated Capacity" is the total of all the batteries rated capacities connected in parallel.

Example: Three (3) 200 Ah batteries are connected in parallel and connected to the main system, then "Battery 1" "Rated Capacity" should be set to 600 Ah.

Figure 5.38 Individual Battery Settings Page (BMS Battery #)



- **Rated Capacity:** Enter the battery string's rated capacity.



**NOTE!** When changing the "Rated Capacity" on a BMS # battery, if there is only (1) Lithium-Ion Battery then you also need to change the "Battery 1" "Rated Capacity" to match. If there are (2) or more Lithium-Ion Batteries connected, then you need to add all the rated capacities of all the Lithium-Ion Batteries and change the "Battery 1" "Rated Capacity" to this value.

Example: Three (3) 100 Ah Lithium-Ion Batteries are connected in parallel to the main system, then

"BMS 01" "Rated Capacity" should be set to 100 Ah

"BMS 02" "Rated Capacity" should be set to 100 Ah

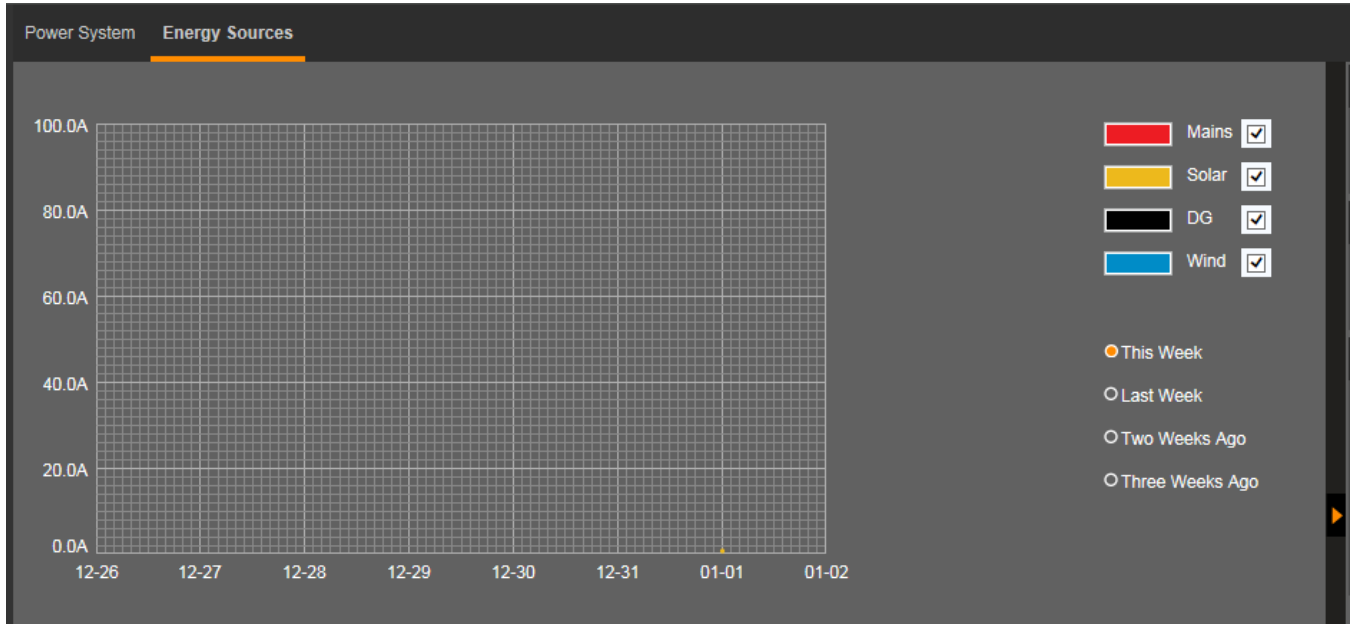
"BMS 03" "Rated Capacity" should be set to 100 Ah

"Battery 1" "Rated Capacity" should be set to 300 Ah.

## 5.8.2 Energy Sources Status Tab

The Energy Sources Status tab displays a chart of the different energy sources available during a selected time period.

Figure 5.39 Energy Sources Status Tab



### 5.8.3 General Status Tab

The General Status tab displays general status information as shown in the following illustration.



**NOTE!** Temperature items are displayed only if temperature probes are connected.

Figure 5.40 General Status Tab

Signal	Value	Signal	Value
Maintenance Run Time	528.9 h	Power Split Mode	Disabled
NCU DI1	Low	NCU DI2	Low
NCU DI3	Low	NCU DI4	Low
IB2-1 DI1	Low	IB2-1 DI2	Low
IB2-1 DI3	Low	IB2-1 DI4	Low
IB2-1 DI5	Low	IB2-1 DI6	Low
IB2-1 DI7	Low	IB2-1 DI8 ESTOP	Low



## 5.8.4 Custom Input Status Tab

The Custom Input Status tab displays general status information for an SM-DUE connected to the controller when a voltage input or a transducer input is being used, as shown in the following illustration.

Figure 5.41 Custom Input Status Tab

SMDUE 1			
Signal	Value	Signal	Value
Current Transducer5	0.0 Gallons	Current Transducer6	0.0 KW
Voltage1	0.0 V	Voltage2	0.0 V
Voltage3	0.0 V	Voltage4	0.0 V
Voltage5	0.0 V	Voltage6	0.0 V
Voltage7	0.0 V	Voltage8	0.0 V
Voltage9	0.0 V	Voltage10	0.0 V

## 5.9 Menu Navigation Area

Available menus are displayed in this area. When a menu is clicked on, the system status screen is replaced with the selected menu's screen. Note that there is a menu item named HOME to return to the system status screen.

Located at the top of each main menus are tabs to select the various sub-menus. If there are more sub-menus then can be displayed in the window, an arrow appears to navigate to the additional sub-menus.

Figure 5.42 Menu Navigation Area

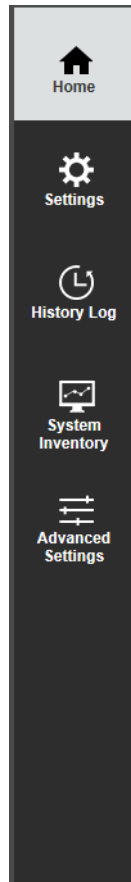
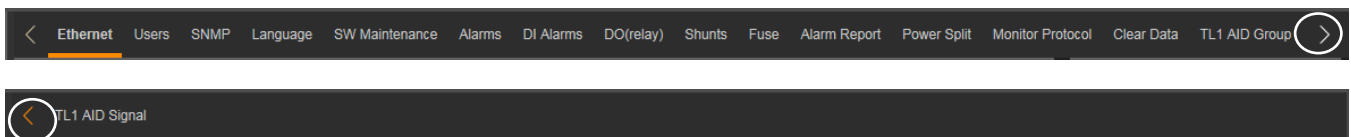


Figure 5.43 Sub-Menu Arrows



## 5.9.1 Settings Menu

The Settings Menu allows you to change (if you have the proper privilege level programmed in your User settings) the settings of the various programmable parameters. Settings are grouped per function. Select a tab in the Settings Menu to change that function's programmable parameters.



**NOTE!** Some parameters are not available for controller configurations that enable controller capability to receive status information sent from FIAMM SoNick (Sodium Nickel) batteries.

Figure 5.44 Settings Menu

The screenshot displays the Settings Menu with the following sections:

- Quick Settings** (selected): System, Battery, ECO, LVD, Temp Probes, Rectifiers, DC/DC Converters, Battery Test, Time Settings
- Site Settings**

Device Name	Signal	Value	Set Value	Set
Site	Site Name	NCU	<input type="text"/>	Set
Site	Site Location	Vertiv	<input type="text"/>	Set
Site	System Name	NCU	<input type="text"/>	Set
- Time Settings**

06/13/2018 15:54:35
- Signal Settings**

Signal	Value	Time Last Set	Set Value	Set
Float Charge Voltage	54.0 V	03/22/2018 10:00:05	<input type="text"/> 42~58	Set
Equalize Charge Voltage	54.0 V	03/22/2018 10:00:13	<input type="text"/> 42~58	Set
Temp Comp Sensor	None	–	None <input type="button" value="v"/>	Set
Temp Comp Coefficient (slope)	40.0 mV/°F	–	<input type="text"/> 0~277.8	Set
Temp Comp Center	77.0 °F	–	<input type="text"/> 32~104	Set
ECO Mode	Disabled	–	<input checked="" type="radio"/> Disabled <input type="radio"/> Enabled	Set
Outgoing Alarms Blocked	Normal	06/13/2018 14:59:26	<input checked="" type="radio"/> Normal <input type="radio"/> Blocked	Set
Batt1 Rated Capacity	50 Ah	05/29/2018 09:58:51	<input type="text"/> 10~50000	Set

## Changing Programmable Parameters in the Settings Menu

To change a programmable parameter, select or enter a new value for the parameter then click on “Set” to change the value.



**NOTE!** Settings that appear “grayed out” can only be made when the controller is in the “manual control” state. If the controller is set for “automatic” control, change the “Auto/Manual State” setting first to the “Manual” setting.



**NOTE!** Some parameters are not available for controller configurations that enable controller capability to receive status information sent from FIAMM SoNick (Sodium Nickel) batteries.

## Quick Settings Tab Programmable Parameter Descriptions

- **Site Settings:** Enter a “Site Name”, “Site Location”, and “System Name”.
- **Time Settings:** Enter the time or select “Get Local Time from Connected PC”.

In the Time Settings section, click on “Get Local Time from Connected PC” and then “Set” to automatically set the date and time. To manually set the date and time, click on “the clock symbol” and enter the date and time. Then select the “Confirm” button. See Figure 5.45. In the Time Settings section, click on “Set” to save the change.

Figure 5.45 Manual Date and Time Menu

The screenshot shows the 'Quick Settings' tab with the following sections:

- Site Settings:**

Device Name	Signal	Value	Set Value	Set
Site	Site Name	NCU	<input type="text"/>	Set
Site	Site Location	Vertiv	<input type="text"/>	Set
Site	System Name	NCU	<input type="text"/>	Set
- Time Settings:**

06/13/2018 15:54:35

Jun 2018

Value	Time Last Set	Set Value	Set
54.0 V	03/22/2018 10:00:05	<input type="text"/> 42~58	Set
54.0 V	03/22/2018 10:00:13	<input type="text"/> 42~58	Set
None	—	None	Set
40.0 mV*F	—	<input type="text"/> 0~277.8	Set
77.0 °F	—	<input type="text"/> 32~104	Set
ECO Mode	Disabled	<input checked="" type="radio"/> Disabled <input type="radio"/> Enabled	Set
Outgoing Alarms Blocked	Normal	06/13/2018 14:59:26 <input checked="" type="radio"/> Normal <input type="radio"/> Blocked	Set
Batt1 Rated Capacity	50 Ah	05/29/2018 09:58:51 <input type="text"/> 10~50000	Set

- **Signal Settings:**
  - **Float Charge Voltage:** Float Charge output voltage setting.
  - **Equalize Charge Voltage:** Equalize Charge output voltage setting.

- **Temp Comp Sensor:** Select "None" for no temperature compensation, or the temperature probe [System Temp1, System Temp2, System Temp3, IB2-1 Temp1, IB2-1 Temp2, IB2-2 Temp1, IB2-2 Temp2, EIB-1 Temp1, EIB-1 Temp2, EIB-2 Temp1, EIB-2 Temp2, SMTemp1 Temp1, ..., SMTemp1 Temp8, ..., SMTemp8 Temp1, ..., SMTemp8 Temp8], SMDUE1 Temp1, ..., SMDUE1 Temp10, SMDUE2 Temp1, ..., SMDUE2 Temp10] sensing battery temperature for temperature compensation. You can also select Maximum or Average which takes the maximum or average reading of the temperature probes [any of System Temp1, System Temp2, System Temp3, IB2-1 Temp1, IB2-1 Temp2, IB2-2 Temp1, IB2-2 Temp2, EIB-1 Temp1, EIB-1 Temp2, EIB-2 Temp1, EIB-2 Temp2, SMTemp1 Temp1, ..., SMTemp1 Temp8, ..., SMTemp8 Temp1, ..., SMTemp8 Temp8], SMDUE1 Temp1, ..., SMDUE1 Temp10, SMDUE2 Temp1, ..., SMDUE2 Temp10] set as battery temperature probes. When set, the following parameters can also be set.
- **Temp Comp Coefficient (slope):** Sets the temperature compensation slope or rate of change per °C above or below the "Temperature Compensation Center" setting. This value is expressed in millivolt per °C per string (mV/°C/str). For example, for a rate of change of 72 mV/°C/str in a 24-cell 48V nominal battery string, the rate of change is 3 mV per cell.
- **Temp Comp Center:** Sets the temperature at which the system operates at normal voltage levels.



**ALERT!** The Energy Optimization Mode should NOT be used in systems that operate without batteries.



**NOTE!** If the battery is ever disconnected, disable Energy Optimization Mode until the battery is reconnected.

- **ECO Mode:** Enables or disables the Energy Optimization Mode feature for all rectifiers. When enabled, the following parameters can be set.
  - Best Operating Point:** Percent of full load capacity that the rectifiers operate under in the Energy Optimization Mode.
  - Load Fluctuation Range:** If load fluctuation is less than this value, rectifiers are not turned on or off for Energy Optimization.
  - Cycle Period:** This is the time period that rectifiers are turned on and off to maintain an equal operating time for all rectifiers in the system.
  - All Rects ON Time:** Time all rectifiers are turned on at the end of the "Cycle Period".
- **Outgoing Alarms Blocked:**
  - Normal:** Alarms are processed normally.
  - Blocked:** Forces the alarm relays in the "off" state and blocks alarms from changing the relay state.
- **Batt1 Rated Capacity:** Enter the battery string's rated capacity.
- **SMDU1Batt2 Rated Capacity:** Enter the battery string's rated capacity.
- **Reset Battery Capacity:** Resets the battery capacity calculation. The only selection is Yes. Once Yes is selected and confirmed, the battery capacity calculation is reset.



**NOTE!** Only reset the battery capacity when the battery is fully charged; otherwise, the battery charge status may not be accurate.

- **Temperature Format:** Sets the temperature display. The choices are: Celsius or Fahrenheit.

### **System Tab Programmable Parameter Descriptions**

- **Under Voltage 1:** Sets the Under Voltage 1 alarm point.
- **Under Voltage 2:** Sets the Under Voltage 2 alarm point.
- **Over Voltage 1:** Sets the Over Voltage 1 alarm point.
- **Over Voltage 2:** Sets the Over Voltage 2 alarm point.
- **System Current Alarm:** Sets the System Current alarm point.
- **High Load Level1:** Sets the High Load Level 1 alarm point (Percentage of total rectifier capacity. When solar converters and rectifiers are both in the system, high load level is based on the capacity of all valid rectifiers and valid solar converters combined. A valid rectifier or solar converter is a unit that is communicating and can deliver power. Note, a solar converter is not valid at night.)



**NOTE!** The systems calculates the capacity based on the nominal ratings under nominal operating conditions.

- **High Load Level2:** Sets the High Load Level 2 alarm point (Percentage of total rectifier capacity. When solar converters and rectifiers are both in the system, high load level is based on the capacity of all valid rectifiers and valid solar converters combined. A valid rectifier or solar converter is a unit that is communicating and can deliver power. Note, a solar converter is not valid at night.)



**NOTE!** The systems calculates the capacity based on the nominal ratings under nominal operating conditions.

- **Relay Test:** Sets the Relay Test feature to Automatic, Manual, or Disabled. Refer to “Using the Relay Test Feature” on page 40.
- **Relay Test Time:** Sets the Relay Test Time for the Automatic Relay Test feature.
- **Main Ambient Temp Sensor:** Sets the temperature sensor which displays the ambient temperature on the Web Interface's Homepage. Note that this temperature sensor **MUST** be set as an ambient temperature sensor. Select "None", or the temperature probe [System Temp1, System Temp2, System Temp3, IB2-1 Temp1, IB2-1 Temp2, IB2-2 Temp1, IB2-2 Temp2, EIB-1 Temp1, EIB-1 Temp2, EIB-2 Temp1, EIB-2 Temp2, SMTemp1 Temp1, ..., SMTemp1 Temp8, ..., SMTemp8 Temp1, ..., SMTemp8 Temp8], SMDUE1 Temp1, ..., SMDUE1 Temp10, SMDUE2 Temp1, ..., SMDUE2 Temp10]. You can also select Maximum or Average which takes the maximum or average reading of the temperature probes [any of System Temp1, System Temp2, System Temp3, IB2-1 Temp1, IB2-1 Temp2, IB2-2 Temp1, IB2-2 Temp2, EIB-1 Temp1, EIB-1 Temp2, EIB-2 Temp1, EIB-2 Temp2, SMTemp1 Temp1, ..., SMTemp1 Temp8, ..., SMTemp8 Temp1, ..., SMTemp8 Temp8], SMDUE1 Temp1, ..., SMDUE1 Temp10, SMDUE2 Temp1, ..., SMDUE2 Temp10] set as ambient temperature probes. When set, the following parameters can also be set.

**Main Ambient Temp High2:** Sets the Main Ambient Temperature High 2 alarm point.

**Main Ambient Temp High1:** Sets the Main Ambient Temperature High 1 alarm point.

**Main Ambient Temp Low:** Sets the Main Ambient Temperature Low alarm point.

- **Fail Safe Mode:** When enabled, sets the relay designated as the "Critical Summary" alarm relay to operate in the "fail safe" mode. In this mode, the relay is energized during normal operation and de-energized for an alarm condition.
- **Rectifier Expansion:**
  - **Inactive:** Select this option if this is the only controller in the power system.
  - **Primary:** Select this option if the power system consists of multiple bays with multiple controllers and this controller is to be the primary controller. Note that only one (1) controller can be set as the primary controller.



**NOTE!** When primary is selected, the controller will start auto configure. This process will take more than three (3) minutes.

- **Secondary:** Select this option if the power system consists of multiple bays with multiple controllers and this controller is to be a secondary controller.



**ALERT!** DO NOT set the controller to Secondary from the Web Interface. You will not be able to log into the controller after it automatically reboots into secondary mode. Controllers to be designated as secondary controllers need to be set locally via the local keypad and display.

**Primary/Secondary Procedure:**

Up to four (4) controllers can be connected together when a power system requires a greater number of rectifiers than can be controlled by a single controller. One (1) controller is designated as the primary controller, the others as secondary controllers. The rectifiers controlled by the secondary controllers are designated as Rectifier Group 2 through 4 in the menus.



**NOTE!** Changing the Rectifier Expansion setting may take more than 3 minutes for the controller to configure the feature.

1. Connect the controllers in the multiple bays via the RS485 interface.
2. Set one of the controllers as the primary controller.
3. Set all other controllers as secondary controllers.



**ALERT!** DO NOT set the controller to Secondary from the Web Interface. You will not be able to log into the controller after it automatically reboots into secondary mode. Controllers to be designated as secondary controllers need to be set locally via the local keypad and display.

4. Set the address of the controllers set as secondary controllers to 201, 202, or 203. Note that each secondary controller must be set to a different address.
- **Power Split Mode:** Enables or disables the power split feature ("disabled" indicates the controller system operates normally and "enabled" indicates the controller system is in Power Split Mode). See "Power Split Feature" on page 9 and "Power Split Feature" on page 46.
  - **Power Split Current Limit Value:** Current limit point for power system designated as "System A" in a "Power Split" configuration.
  - **Delta Voltage:** The offset voltage that the power system designated as "System A" in a "Power Split" configuration is set to. It is suggested to leave this value at the default (0.5 volts).
  - **Outgoing Alarms Blocked:**
    - **Normal:** Alarms are processed normally.
    - **Blocked:** Forces the alarm relays in the "off" state and blocks alarms from changing the relay state.
  - **EStop / EShutdown**
    - **Disabled:** Disables the Emergency Stop and Emergency Shutdown functions.
    - **EStop:** Enables the Emergency Stop function. (If utilized in the system, an Estop signal shuts down and locks out the system. The system must be manually restarted. Refer to the system instruction manual for restarting procedure.)
    - **EShutdown:** Enables the Emergency Shutdown function. (If utilized in the system, an EShutdown signal shuts down the system. The system automatically restarts when the signal is removed.)
  - **Audible Alarm**
    - **Off:** Disables the audible alarm.
    - **On:** When a new alarm occurs, the audible alarm sounds. Press any key to silence the audible alarm.
    - **3 min / 10 min / 1 hr / 4 hrs:** When a new alarm occurs, the audible alarm sounds. The audible alarm automatically silences after the selected time period.
  - **Auto/Manual State:**
    - **Auto:** The controller automatically controls the power system.

- **Manual:** A User can manually change certain power system control settings. When you return to Auto Mode, any settings changed in Manual Mode are returned to their previous setting (setting before being placed in Manual Mode). This provides a convenient means of making temporary adjustment changes for testing purposes.
- **Manual Mode Time Limit:** Time delay before returning to automatic control after being set for manual control. A "0" setting disables the "Manual Mode Time Limit" feature and the controller **MUST** be manually set to Auto control after being set to Manual control.
- **Maintenance Cycle:** Enables or disables the maintenance cycle timer. When enabled, the following parameter can be set.
 

**Maintenance Cycle Time:** The maintenance cycle time is the number of days before a maintenance alarm is issued. To reset the maintenance timer and clear the maintenance alarm, clear the maintenance run time (Clear Maintenance Run Time menu item, see also "Clearing the Maintenance Alarm" on page 41).
- **Clear Maintenance Run Time:** In manual mode, the only selection for "Clear Maintenance Run Time" is Yes. Once Yes is selected and confirmed, the Power System's Maintenance Run Time log is cleared.
- **LCD Rotation:** Sets the rotation of the text in the menus (allowing the controller to be mounted in different orientations).
  - **0 deg:** Display will be in the horizontal position (M830B only).
  - **90 deg:** Display will be in the vertical position (controller mounted 90 deg clockwise) (M830B only).
  - **Big Screen:** Setting for M830D only.
- **Solar Mode:** Sets solar mode as Disabled, RECT-SOLAR, or SOLAR.
  - **Disabled:** Disables the solar mode function.
  - **RECT-SOLAR:** If you have both rectifiers and solar converters in the system, set Solar Mode to "RECT-SOLAR". In the Battery Settings tab, also set the "Float Charge Voltage (Solar)" parameter to the desired float setting. The parameter "Float Charge Voltage (Rect)" setting **MUST** be set 0.3 V lower than the "Float Charge Voltage (Solar)" parameter setting for solar converters to operate properly.
  - **SOLAR:** If you have only solar converters in the system, set Solar Mode to "SOLAR". Reboot the controller (see "Rebooting the Controller" on page 44) after changing setting to SOLAR.
- **HTD Point:** Sets high temperature limit at which LVD1 and/or LVD2 contactors will open (disconnect) if the HTD1 and/or HTD2 features are enabled. If this temperature is reached, a disconnect occurs regardless of voltage.



**NOTE!** This feature requires a BTRM sensor. The BTRM sensor is the sensor which is used for the High Temperature Disconnect (HTD) Feature.

- **HTD Reconnect Point:** Sets temperature at which a reconnect will occur following a high temperature disconnect.
- **Time Display Format:** Sets the format of the date. The choices are: DD/MM/YYYY, MM/DD/YYYY, or YYYY/MM/DD.
- **Temperature Format:** Sets the temperature display. The choices are: Celsius or Fahrenheit.
- **System Alarm Function:** Sets what types of alarms the BAY alarm LED will light (if the system provides a Bay Alarm led). The choices are: "CR Only", "CR and MJ", and "CR, MJ and MN".
- **AC Generator Function:** This is a special function to control an AC generator. The AC generator control signal is connected to an available controller relay output. This relay needs to be selected by the User and be available for this feature. When the relay is energized (On), the generator is On. When the relay is de-energized (Off), the generator is Off. The generator is programmed to start (User selected) when either the output voltage (AC Generator Start Voltage setting) or battery capacity (AC Generator Start Capacity setting) decreases to the set point. This triggers the "Automatic AC Generator Run" alarm and turns on the relay associated to this alarm to start the generator. The AC generator function utilizes the "Auto EQ" function to determine when to shut the generator off. When the "Auto EQ" shuts off, the AC generator



will shut off and the AC generator function will reset. If the generator is told to run and the plant DC voltage is above the “AC Generator Start Voltage” and after 5 minutes you don’t get the “Auto EQ” alarm, then the generator turns off. The AC generator can also be started manually (enable “Manual AC Generator Run”). The AC generator will stay running as long as you are in the “Manual AC Generator Run” mode.

- **“AC Generator Function”:** Select “Disabled” (default), “Voltage”, or “Battery Capacity”.
- a) When “Voltage” is selected, the following menu items are available.

AC Generator Function	Voltage	01/12/2008 21:52:05	Disabled	Set
Manual AC Generator Run	Disabled	–	<input checked="" type="radio"/> Disabled <input type="radio"/> Enabled	Set
AC Generator Start Voltage	44.0 V	–	<input type="text"/> 42~56	Set
DI for AC Generator	None	–	None	Set
Site Has AC Utility Power	No	–	<input checked="" type="radio"/> No <input type="radio"/> Yes	Set

- **Manual AC Generator Run:** Turns on the AC Generator manually (select “Enabled”). The “Manual AC Generator Run” alarm activates to trigger the associated relay to start the generator. To turn off the generator, select “Disabled”.
- **AC Generator Start Voltage:** When output voltage decreases to this setting, the “Automatic AC Generator Run” alarm activates to trigger the associated relay to start the generator.
- **DI for AC Generator (optional):** A signal from the AC Generator can be connected to this controller digital input to indicate it is running. If this signal does not change state when the generator should be running, the “AC Generator Fail” alarm activates.
- **Site Has AC Utility Power (optional):** Used to suppress the “AC Mains Failure” alarm.
- b) When “Battery Capacity” is selected, the following menu items are available.

AC Generator Function	Battery Capacity	01/12/2008 21:52:45	Disabled	Set
Manual AC Generator Run	Disabled	–	<input checked="" type="radio"/> Disabled <input type="radio"/> Enabled	Set
AC GEN Start Batt Capacity	40.0 %	–	<input type="text"/> 20~80	Set
DI for AC Generator	None	–	None	Set
Site Has AC Utility Power	No	–	<input checked="" type="radio"/> No <input type="radio"/> Yes	Set

- **Manual AC Generator Run:** Turns on the AC Generator manually (select “Enabled”). The “Manual AC Generator Run” alarm activates to trigger the associated relay to start the generator. To turn off the generator, select “Disabled”.
- **AC GEN Start Batt Capacity:** When battery capacity decreases to this setting, the “Automatic AC Generator Run” alarm activates to trigger the associated relay to start the generator.
- **DI for AC Generator (optional):** A signal from the AC Generator can be connected to this controller digital input to indicate it is running. If this signal does not change state when the generator should be running, the “AC Generator Fail” alarm activates.
- **Site Has AC Utility Power (optional):** Used to suppress the “AC Mains Failure” alarm.
- c) Associated Alarms (see “Alarms Tab” on page 188 in the Advance Settings menu). See also Table 2.3 on page 58.
  - Automatic AC Generator Run
  - Manual AC Generator Run

- EQ Time Out
- AC GEN Start by Voltage
- AC Gen Start by Batt Capacity
- AC Generator Fail

d) Notes:

- This function uses the AUTO EQ function to determine when the AC generator turns back off. See “Setting Auto Equalize” on page 29.
- By default, the relay being used for the generator is not selected. The User must go into the “Alarms” tab in the Advance Settings menu and select the relay for both alarms named “Automatic AC Generator Run” and “Manual AC Generator Run”. The same relay must be selected for each of these alarms. This relay must not be assigned to any other alarm.
- The severity for all alarms can be changed but not set to “NA” or the function will not work properly.
- If using solar converters in your system, it is recommended to set the "EQ Charge Voltage (Solar)" lower than the "EQ Charge Voltage(RECT)" to ensure the generator is the source providing the power to the load during the day and not running unloaded.

### **Battery Tab Programmable Parameter Descriptions**

- **Equalize/Float Charge Control:** Places the system in Equalize Charge or Float Charge mode.

With no solar converters installed, the following parameters are displayed:

- **Float Charge Voltage:** Rectifier float charge output voltage setting.
- **Equalize Charge Voltage:** Rectifier equalize charge output voltage setting.

With solar converters installed, the following parameters are displayed:

- **Float Charge Voltage(Solar):** Solar converter float charge output voltage setting.
- **EQ Charge Voltage(Solar):** Solar converter equalize charge output voltage setting.
- **Float Charge Voltage(RECT):** Rectifier float charge output voltage setting.
- **EQ Charge Voltage(RECT):** Rectifier equalize charge output voltage setting.
  
- **Battery 1 Shunt:** Selects Battery 1 Shunt (Yes or No).
- **Batt1 Rated Capacity:** Enter the battery string's rated capacity. After setting the battery capacity, the User should also reset the battery capacity (battery must be fully charged). See “Setting Battery Capacity Parameters” on page 31.
- **Reset Battery Capacity:** Resets the battery capacity calculation. The only selection is Yes. Once Yes is selected and confirmed, the battery capacity calculation is reset.



**NOTE!** Only reset the battery capacity when the battery is fully charged; otherwise, the battery charge status may not be accurate.

- **Number of Battery Fuses:** Designates the number of battery fuses in the system.
- **Calculate Battery Current:** Selects whether or not the controller calculates the battery current in the case of no battery shunt (load shunt required).
- **Temp Comp Sensor:** Select "None" for no temperature compensation, or the temperature probe [System Temp1, System Temp2, System Temp3, IB2-1 Temp1, IB2-1 Temp2, IB2-2 Temp1, IB2-2 Temp2, EIB-1 Temp1, EIB-1 Temp2, EIB-2 Temp1, EIB-2

Temp2, SMTemp1 Temp1, ..., SMTemp1 Temp8, ..., SMTemp8 Temp1, ..., SMTemp8 Temp8], SMDUE1 Temp1, ..., SMDUE1 Temp10, SMDUE2 Temp1, ..., SMDUE2 Temp10] sensing battery temperature for temperature compensation. You can also select Maximum or Average which takes the maximum or average reading of the temperature probes [any of System Temp1, System Temp2, System Temp3, IB2-1 Temp1, IB2-1 Temp2, IB2-2 Temp1, IB2-2 Temp2, EIB-1 Temp1, EIB-1 Temp2, EIB-2 Temp1, EIB-2 Temp2, SMTemp1 Temp1, ..., SMTemp1 Temp8, ..., SMTemp8 Temp1, ..., SMTemp8 Temp8], SMDUE1 Temp1, ..., SMDUE1 Temp10, SMDUE2 Temp1, ..., SMDUE2 Temp10] set as battery temperature probes. When set, the following parameters can also be set.

**Comp Temp High 2:** Sets the Compensation Temperature High 2 alarm point.

**Comp Temp High 1:** Sets the Compensation Temperature High 1 alarm point.

**Comp Temp Low:** Sets the Compensation Temperature Low alarm point.

**Temp Comp Off When:** Temperature compensation shuts off and the system returns to float if “All Probes Fail” or “Any Probe Fails”. “All Probes Fail” is the default setting.

**Temp Comp Center:** Sets the temperature at which the system operates at normal voltage levels.

**Temp Comp Coefficient (slope):** Sets the temperature compensation slope or rate of change per °C above or below the “Temperature Compensation Center” setting. This value is expressed in millivolt per °C per string (mV/°C/str). For example, for a rate of change of 72 mV/°C/str in a 24-cell 48V nominal battery string, the rate of change is 3 mV per cell.

**Temp Comp Threshold Enabled:** When enabled, turns on temperature compensation at the “Temp for Temp Comp On” setting and turns off temperature compensation (the system returns to float) at the “Temp for Temp Comp Off” setting. “Disabled” is the default setting. When enabled, the following parameters can also be set

**Temp for Temp Comp Off:** See “Temp Comp Threshold Enabled” above. “55 °C” is the default setting.

**Temp for Temp Comp On:** See “Temp Comp Threshold Enabled” above. “50 °C” is the default setting.

**Temp Comp Voltage Clamp:** Enables or disables the temperature compensation voltage clamp feature.

**Temp Comp Max Voltage:** Upper voltage limit where battery temperature compensation clamps the voltage.

**Temp Comp Min Voltage:** Lower voltage limit where battery temperature compensation clamps the voltage.

- **BTRM Temp Sensor:** Sets the BTRM (Battery Thermal Runaway Management) temperature sensor. Note that this temperature sensor MUST be set as a battery temperature sensor. Select “None”, or the temperature probe [System Temp1, System Temp2, System Temp3, IB2-1 Temp1, IB2-1 Temp2, IB2-2 Temp1, IB2-2 Temp2, EIB-1 Temp1, EIB-1 Temp2, EIB-2 Temp1, EIB-2 Temp2, SMTemp1 Temp1, ..., SMTemp1 Temp8, ..., SMTemp8 Temp1, ..., SMTemp8 Temp8], SMDUE1 Temp1, ..., SMDUE1 Temp10, SMDUE2 Temp1, ..., SMDUE2 Temp10]. You can also select Maximum or Average which takes the maximum or average reading of the temperature probes [any of System Temp1, System Temp2, System Temp3, IB2-1 Temp1, IB2-1 Temp2, IB2-2 Temp1, IB2-2 Temp2, EIB-1 Temp1, EIB-1 Temp2, EIB-2 Temp1, EIB-2 Temp2, SMTemp1 Temp1, ..., SMTemp1 Temp8, ..., SMTemp8 Temp1, ..., SMTemp8 Temp8], SMDUE1 Temp1, ..., SMDUE1 Temp10, SMDUE2 Temp1, ..., SMDUE2 Temp10] set as battery temperature probes. When set, the following parameters can also be set.



**NOTE!** The BTRM sensor is the sensor which is used for the High Temperature Disconnect (HTD) Feature.

**BTRM Temp High 2:** Sets the BTRM Temperature High 2 alarm point. If battery temperature exceeds this setting, system voltage is lowered to the “BTRM Voltage” setting (if “BTRM Action” is set to “Lower Voltage”).

**BTRM Temp High 1:** Sets the BTRM Temperature High 1 alarm point.

**BTRM Temp Delta Over Ambient:** Only visible if a selection is made for the Main Ambient Temp Sensor (the sensor which displays the ambient temperature on the Web Interface's Homepage) and a selection is made for the BTRM Temp Sensor (see "Setting Temperature Sensors" on page 33). See also "Setting Battery Thermal Runaway Management (BTRM) Feature" on page 34. The value represents the temperature difference between the BTRM Temp Sensor value and the Main Ambient Temp Sensor value that will generate the BTRM Temp Delta Alarm, based on the selection below.

**BTRM Temp Delta Alarm:** Only visible if a selection is made for the Main Ambient Temp Sensor (the sensor which displays the ambient temperature on the Web Interface's Homepage) and a selection is made for the BTRM Temp Sensor (see "Setting Temperature Sensors" on page 33). See also "Setting Battery Thermal Runaway Management (BTRM) Feature" on page 34. Determines the criteria for which the "BTRM Temp Delta" alarm will activate. Set to "Amb Delta" to activate the alarm if the temperature difference exceeds the set point above. Set to "High1+Amb Delta" to activate the alarm if both the BTRM Temp Sensor value exceeds the BTRM Temp High1 set point AND the temperature difference exceeds the set point.

#### **BTRM Action:**

- **Disabled:** Disables the Battery Thermal Runaway Management feature.
- **Lower Voltage:** Sets the Battery Thermal Runaway Management feature to reducing the output voltage when battery temperature exceeds the BTRM Temperature High 2 alarm point.

When enabled, the following parameter can be set.

**BTRM Voltage:** Voltage that the system is set to when battery temperature exceeds the "BTRM Temperature High 2" alarm point.

- **Low Capacity Point:** Battery low capacity alarm set point.
- **Battery Current Limited Mode:** Selects the battery current limit mode (Yes or No).



**NOTE!** *If battery current limit is utilized, it is important to also have provisions for battery testing/monitoring.*



**NOTE!** *If the battery is ever disconnected, disable battery current limit until the battery is reconnected.*

- **Battery Current Limit:** Maximum battery charging current setting. For example, a value of 0.150C10 means that the charging current is limited to 15% of the battery's nominal capacity.
- **Over Current Limit:** Battery over current alarm setting. For example, a value of 0.300C10 means that when the charging current reaches 30% of the battery's nominal capacity, an alarm will be extended.
- **Automatic Equalize:** Enables or disables the Automatic Equalize Charge feature. When enabled, the following parameters can be set.

**Equalize Start Current:** The system is transferred to Equalize Charge mode when battery charge current increases to this setting. For example, a value of 0.060C10 means that an Automatic Equalize is started if the battery charge current is greater than 6% of the battery's nominal capacity.

**Equalize Start Capacity:** The system is transferred to Equalize Charge mode when remaining battery capacity decreases to this setting.

- **Equalize Stop Current:** When in Equalize Charge mode and the battery charge current decreases below this setting for the "Equalize Charge Stop Delay Time" time period, the system is transferred to Float Charge mode. For example, a value of 0.010C10 means that when the charging current is less than 1% of the battery's nominal capacity, the system returns to the Float mode.

- **Equalize Stop Delay Time:** See "Equalize Stop Current" above.



**NOTE!** *If the power system has been automatically placed in Equalize mode, disabling Automatic Equalize will **not** return the system to Float mode until the current Equalize cycle is completed. To return immediately to Float mode, select Float Charge for the Equalize/Float Charge Control setting.*

- **Maximum Equalize Charge:** This is the maximum duration, in minutes, that an automatic equalize charge will last regardless of the other settings.
- **Cyclic Equalize :** Enables or disables cyclic (scheduled) equalize charging. When enabled, the following parameters can be set.

**Cyclic Equalize Interval:** Cyclic (scheduled) equalize charging interval.

**Cyclic Equalize Duration:** Cyclic (scheduled) equalize charging duration.

- **Cyclic Equalize Start Time:** Sets the start time for equalizing (date/time you want the cyclic EQ to start). The date is displayed based on the Date Format selected.  
Example setting: mm/dd/yyyy hr.
- **EIB-1 Voltage Type:** The EIB assembly provides a total of eight (8) DC voltage inputs for battery block monitoring.
  - **24 (Block 2):** Selects the EIB to monitor up to four (4) 24V battery strings with two (2) 12V blocks per string.
  - **48 (Block 4):** Selects the EIB to monitor up to two (2) 48V battery strings with four (4) 12V blocks per string.
  - **Mid Point:** Selects the EIB to monitor the midpoint voltage of up to eight (8) battery strings for either 24V or 48V systems.
  - **Disabled:** Disables the battery block monitoring feature.
- **EIB-1 Block Voltage Diff:** This menu item appears if "24 (Block 2)" or "48 (Block 4)" is selected above. The "EIB-1 Block Voltage Diff" setting selects the alarm threshold for battery block monitoring. The controller issues an alarm when any block voltage of any battery string has an abnormal value. The alarm is issued when the difference between any block voltage and a reference voltage is greater than the value of the block voltage difference setting.
- **EIB-1 Block Voltage Diff (Mid):** This menu item appears if "Mid Point" is selected above. The "EIB-1 Block Voltage Diff (Mid)" setting selects the alarm threshold for battery midpoint monitoring. The controller issues an alarm when any battery midpoint voltage of any battery string has an abnormal value. The alarm is issued when the difference between any battery midpoint voltage and a reference voltage is greater than the value of the block voltage difference setting.
- **EIB-1 Block In-Use Num:** Number of 12V battery blocks being used.
- **EIB-2 Voltage Type:** The EIB assembly provides a total of eight (8) DC voltage inputs for battery block monitoring.
  - **24 (Block 2):** Selects the EIB to monitor up to four (4) 24V battery strings with two (2) 12V blocks per string.
  - **48 (Block 4):** Selects the EIB to monitor up to two (2) 48V battery strings with four (4) 12V blocks per string.
  - **Mid Point:** Selects the EIB to monitor the midpoint voltage of up to eight (8) battery strings for either 24V or 48V systems.
  - **Disabled:** Disables the battery block monitoring feature.
- **EIB-2 Block Voltage Diff:** This menu item appears if "24 (Block 2)" or "48 (Block 4)" is selected above. The "EIB-2 Block Voltage Diff" setting selects the alarm threshold for battery block monitoring. The controller issues an alarm when any block voltage of any battery string has an abnormal value. The alarm is issued when the difference between any block voltage and a reference voltage is greater than the value of the block voltage difference setting.
- **EIB-2 Block Voltage Diff (Mid):** This menu item appears if "Mid Point" is selected above. The "EIB-2 Block Voltage Diff (Mid)" setting selects the alarm threshold for battery midpoint monitoring. The controller issues an alarm when any battery

midpoint voltage of any battery string has an abnormal value. The alarm is issued when the difference between any battery midpoint voltage and a reference voltage is greater than the value of the block voltage difference setting.

- **EIB-2 Block In-Use Num:** Number of 12V battery blocks being used.
- **Charging Efficiency:** Value used to calculate remaining capacity of the battery.
- **Time 0.1C10:** Discharge time with a discharge current of 0.1C10.
- **Time 0.2C10:** Discharge time with a discharge current of 0.2C10.
- **Time 0.3C10:** Discharge time with a discharge current of 0.3C10.
- **Time 0.4C10:** Discharge time with a discharge current of 0.4C10.
- **Time 0.5C10:** Discharge time with a discharge current of 0.5C10.
- **Time 0.6C10:** Discharge time with a discharge current of 0.6C10.
- **Time 0.7C10:** Discharge time with a discharge current of 0.7C10.
- **Time 0.8C10:** Discharge time with a discharge current of 0.8C10.
- **Time 0.9C10:** Discharge time with a discharge current of 0.9C10.
- **Time 1.0C10:** Discharge time with a discharge current of 1.0C10.
- **Clear Abnormal Bat Current:** Clears an abnormal battery current alarm. The only selection is Yes. Once Yes is selected and confirmed, the alarm clears.

### **ECO Tab Programmable Parameter Descriptions**

- **ECO Mode:** Enables or disables the Energy Optimization Mode feature for all rectifiers. When enabled, the following parameters can be set.



**ALERT!** The Energy Optimization Mode should NOT be used in systems that operate without batteries.



**NOTE!** *If the battery is ever disconnected, disable Energy Optimization Mode until the battery is reconnected.*

**Best Operating Point:** Percent of full load capacity that the rectifiers operate under in the Energy Optimization mode.

**Load Fluctuation Range:** If load fluctuation is less than this value, rectifiers are not turned on or off for Energy Optimization.

**System Energy Saving Point:** Energy Optimization is disabled if the load is greater than this setting.

**Cycle Period:** This is the time period that rectifiers are turned on and off to maintain an equal operating time for all rectifiers in the system.

**All Rects ON Time:** Time all rectifiers are turned on at the end of the “Cycle Period”.

**Turn Off Delay:** When the Energy Optimization feature determines a rectifier can be switched off, this is the time delay before the rectifier is turned off.

- **Clear Cycle Alarm:** Resets the ECO Cycle Alarm. The only selection is Yes. Once Yes is selected and confirmed, the alarm resets.

## **LVD Tab Programmable Parameter Descriptions**

### **LVD Unit**

- **LVD 1:** Enables or disables LVD 1. When enabled, the following parameters can be set.
  - LVD 1 Mode:** Sets LVD 1 to disconnect on a voltage or time setpoint.
  - LVD 1 Disconnect Voltage:** LVD 1 low voltage disconnect setting (when LVD set for voltage)
  - LVD 1 Reconnect Voltage:** LVD 1 reconnect setting (when LVD set for voltage).
  - LVD 1 Reconnect Delay:** Delay time period until LVD 1 reconnects once voltage recovers (when LVD set for voltage).
  - LVD 1 Time:** The time period before LVD 1 disconnection once an AC fail condition occurs ( when LVD set for time).
  - LVD 1 Dependency:** Select if LVD 1 can disconnect only if LVD2 has disconnected, or none.
  - LVD 1 High Temp Disconnect:** Enables or disables the High Temperature 1 Disconnect feature. This feature causes LVD 1 contactors to open (disconnect) if a high temperature event occurs. (See "HTD Point" and "HTD Reconnect Point" under the "System Tab Programmable Parameter Descriptions" starting on page 135.)
- **LVD 2:** Enables or disables LVD 2. When enabled, the following parameters can be set.
  - LVD 2 Mode:** Sets LVD 2 to disconnect on a voltage or time setpoint.
  - LVD 2 Disconnect Voltage:** LVD 2 low voltage disconnect setting (when LVD set for voltage)
  - LVD 2 Reconnect Voltage:** LVD 2 reconnect setting (when LVD set for voltage).
  - LVD 2 Reconnect Delay:** Delay time period until LVD 2 reconnects once voltage recovers (when LVD set for voltage).
  - LVD 2 Time:** The time period before LVD 2 disconnection once an AC fail condition occurs ( when LVD set for time).
  - LVD 2 Dependency:** Select if LVD 2 can disconnect only if LVD 1 has disconnected, or none.
  - LVD 2 High Temp Disconnect:** Enables or disables the High Temperature 2 Disconnect feature. This feature causes LVD 2 contactors to open (disconnect) if a high temperature event occurs. (See "HTD Point" and "HTD Reconnect Point" under the "System Tab Programmable Parameter Descriptions" starting on page 135.)
- **LVD Contactor Type:** Select the type of LVD Contactor. This setting should not be changed.
- **LVD 1 Control:** Temporarily connects or disconnects LVD 1 when the controller is in Manual mode. Setting returns to original when controller is returned to the Auto mode.
- **LVD 2 Control:** Temporarily connects or disconnects LVD 2 when the controller is in Manual mode. Setting returns to original when controller is returned to the Auto mode.

### **SMDU 1 LVD**

- **LVD 1:** Enables or disables LVD 1. When enabled, the following parameters can be set.
  - LVD 1 Mode:** Sets LVD 1 to disconnect on a voltage or time setpoint.
  - LVD 1 Disconnect Voltage:** LVD 1 low voltage disconnect setting (when LVD set for voltage)
  - LVD 1 Reconnect Voltage:** LVD 1 reconnect setting (when LVD set for voltage).
  - LVD 1 Reconnect Delay:** Delay time period until LVD 1 reconnects once voltage recovers (when LVD set for voltage).
  - LVD 1 Time:** The time period before LVD 1 disconnection once an AC fail condition occurs ( when LVD set for time).

**LVD 1 Dependency:** Select if LVD 1 can disconnect only if LVD2 has disconnected, or none.

**LVD 1 High Temp Disconnect:** Enables or disables the High Temperature 1 Disconnect feature. This feature causes LVD 1 contactors to open (disconnect) if a high temperature event occurs. (See "HTD Point" and "HTD Reconnect Point" under the "System Tab Programmable Parameter Descriptions" starting on page 135.)

- **LVD 2:** Enables or disables LVD 2. When enabled, the following parameters can be set.

**LVD 2 Mode:** Sets LVD 2 to disconnect on a voltage or time setpoint.

**LVD 2 Disconnect Voltage:** LVD 2 low voltage disconnect setting (when LVD set for voltage)

**LVD 2 Reconnect Voltage:** LVD 2 reconnect setting (when LVD set for voltage).

**LVD 2 Reconnect Delay:** Delay time period until LVD 2 reconnects once voltage recovers (when LVD set for voltage).

**LVD 2 Time:** The time period before LVD 2 disconnection once an AC fail condition occurs ( when LVD set for time).

**LVD 2 Dependency:** Select if LVD 2 can disconnect only if LVD 1 has disconnected, or none.

**LVD 2 High Temp Disconnect:** Enables or disables the High Temperature 2 Disconnect feature. This feature causes LVD 2 contactors to open (disconnect) if a high temperature event occurs. (See "HTD Point" and "HTD Reconnect Point" under the "System Tab Programmable Parameter Descriptions" starting on page 135.)

### **Temp Probes Tab Programmable Parameter Descriptions**

- **IB2-1 Temp 1:** Sets temperature port 1 on the IB2-1 board to None, Battery, or Ambient. When set, the following parameters can also be set.

**IB2-1 Temp1 High 2:** Sets temperature port 1 on the IB2-1 board "Temperature High 2" alarm point.

**IB2-1 Temp1 High 1:** Sets temperature port 1 on the IB2-1 board "Temperature High 1" alarm point.

**IB2-1 Temp1 Low:** Sets temperature port 1 on the IB2-1 board "Temperature Low" alarm point.

- **IB2-1 Temp 2:** Sets temperature port 2 on the IB2-1 board to None, Battery, or Ambient. When set, the following parameters can also be set.

**IB2-1 Temp2 High 2:** Sets temperature port 2 on the IB2-1 board "Temperature High 2" alarm point.

**IB2-1 Temp2 High 1:** Sets temperature port 2 on the IB2-1 board "Temperature High 1" alarm point.

**IB2-1 Temp2 Low:** Sets temperature port 2 on the IB2-1 board "Temperature Low" alarm point.

- **IB2-2 Temp 1:** Sets temperature port 1 on the IB2-2 board to None, Battery, or Ambient. When set, the following parameters can also be set.

**IB2-2 Temp1 High 2:** Sets temperature port 1 on the IB2-2 board "Temperature High 2" alarm point.

**IB2-2 Temp1 High 1:** Sets temperature port 1 on the IB2-2 board "Temperature High 1" alarm point.

**IB2-2 Temp1 Low:** Sets temperature port 1 on the IB2-2 board "Temperature Low" alarm point.

- **IB2-2 Temp 2:** Sets temperature port 2 on the IB2-2 board to None, Battery, or Ambient. When set, the following parameters can also be set.

**IB2-2 Temp2 High 2:** Sets temperature port 2 on the IB2-2 board "Temperature High 2" alarm point.

**IB2-2 Temp2 High 1:** Sets temperature port 2 on the IB2-2 board "Temperature High 1" alarm point.



**IB2-2 Temp2 Low:** Sets temperature port 2 on the IB2-2 board “Temperature Low” alarm point.

- **EIB-1 Temp 1:** Sets temperature port 1 on the EIB-1 board to None, Battery, or Ambient. When set, the following parameters can also be set.

**EIB-1 Temp1 High 2:** Sets temperature port 1 on the EIB-1 board “Temperature High 2” alarm point.

**EIB-1 Temp1 High 1:** Sets temperature port 1 on the EIB-1 board “Temperature High 1” alarm point.

**EIB-1 Temp1 Low:** Sets temperature port 1 on the EIB-1 board “Temperature Low” alarm point.

- **EIB-1 Temp 2:** Sets temperature port 2 on the EIB-1 board to None, Battery, or Ambient. When set, the following parameters can also be set.

**EIB-1 Temp2 High 2:** Sets temperature port 2 on the EIB-1 board “Temperature High 2” alarm point.

**EIB-1 Temp2 High 1:** Sets temperature port 2 on the EIB-1 board “Temperature High 1” alarm point.

**EIB-1 Temp2 Low:** Sets temperature port 2 on the EIB-1 board “Temperature Low” alarm point.

- **EIB-2 Temp 1:** Sets temperature port 1 on the EIB-2 board to None, Battery, or Ambient. When set, the following parameters can also be set.

**EIB-2 Temp1 High 2:** Sets temperature port 1 on the EIB-2 board “Temperature High 2” alarm point.

**EIB-2 Temp1 High 1:** Sets temperature port 1 on the EIB-2 board “Temperature High 1” alarm point.

**EIB-2 Temp1 Low:** Sets temperature port 1 on the EIB-2 board “Temperature Low” alarm point.

- **EIB-2 Temp 2:** Sets temperature port 2 on the EIB-2 board to None, Battery, or Ambient. When set, the following parameters can also be set.

**EIB-2 Temp2 High 2:** Sets temperature port 2 on the EIB-2 board “Temperature High 2” alarm point.

**EIB-2 Temp2 High 1:** Sets temperature port 2 on the EIB-2 board “Temperature High 1” alarm point.

**EIB-2 Temp2 Low:** Sets temperature port 2 on the EIB-2 board “Temperature Low” alarm point.

- **SMTemp# Temp #:** Sets temperature port # on the SM-Temp # module to None, Battery, or Ambient. When set, the following parameters can also be set.

**SMTemp# Temp# High 2:** Sets temperature port # on the SM-Temp # module “Temperature High 2” alarm point.

**SMTemp# Temp# High 1:** Sets temperature port # on the SM-Temp # module “Temperature High 1” alarm point.

**SMTemp# Temp# Low:** Sets temperature port # on the SM-Temp # module “Temperature Low” alarm point.

- **Clear SM Temp Lost Alarm:** Clears an SM Temp lost alarm. The only selection is Clear. Once Clear is selected and confirmed, the alarm clears.
- **SMTEMP# Clear Probe Alarm:** Clears an SM Temp Probe Fail alarm. The only selection is Clear. Once Clear is selected and confirmed, the alarm clears.
- **SMDUE1 Temp #:** Sets temperature port # on the SMDUE1 module to None, Battery, or Ambient. When set, the following parameters can also be set. Note that one or more analog inputs on SMDUE1 needs to be configured for temperature ports (Advance Settings Menu / Custom Inputs Tab / SMDUE #).

**SMDUE1 Temp# High 2:** Sets temperature port # on the SMDUE1 module “Temperature High 2” alarm point.

**SMDUE1 Temp# High 1:** Sets temperature port # on the SMDUE1 module “Temperature High 1” alarm point.

**SMDUE1 Temp# Low:** Sets temperature port # on the SMDUE1 module “Temperature Low” alarm point.

- **SMDUE2 Temp #:** Sets temperature port # on the SMDUE2 module to None, Battery, or Ambient. When set, the following parameters can also be set. Note that one or more analog inputs on SMDUE2 needs to be configured for temperature ports (Advance Settings Menu / Custom Inputs Tab / SMDUE #).

**SMDUE2 Temp# High 2:** Sets temperature port # on the SMDUE2 module “Temperature High 2” alarm point.

**SMDUE2 Temp# High 1:** Sets temperature port # on the SMDUE2 module “Temperature High 1” alarm point.

**SMDUE2 Temp# Low:** Sets temperature port # on the SMDUE2 module “Temperature Low” alarm point.

### **Rectifiers Tab Programmable Parameter Descriptions**

- **Current Limit:** Enables or disables adjusting the output current limit point. When enabled, the following parameters can be set.



**NOTE!** *By default this is set to disabled. When disabled, rectifier current limit is set in the rectifier (not via the controller) at the maximum current limit point.*

**Current Limit Point:** Sets the output current limit point for all rectifiers combined when the “Current Limit” setting above is set to enabled.

- **HVSD Limit:** Sets the High Voltage Shutdown point for all rectifiers.
- **Restart on HVSD:** Enables or disables the High Voltage Shutdown Restart feature for all rectifiers.
- **HVSD Restart Time:** When the High Voltage Shutdown Restart feature is enabled and the output exceeds the high voltage limit, the rectifiers restart after this time period expires.
- **Walk-In:** Enables or disables the start-up walk-in feature for all rectifiers. When enabled, the following parameters can be set.

**Walk- In Time:** Sets the start-up walk-in time when the “Walk-In” setting above is set to enabled.

- **Sequence Start Interval:** Sets the sequence start interval (time period between starting each rectifier in the system).
- **Nominal AC Voltage:** Enter the nominal line to neutral voltage (signal phase rectifier) or nominal line to line voltage (three phase rectifier).
- **Mains Failure Alarm Limit 1:** Sets the Mains Failure Alarm 1 value (percent of nominal).
- **Mains Failure Alarm Limit 2:** Sets the Mains Failure Alarm 2 value (percent of nominal).

#### **Corresponding Alarms:**

- Phase A Voltage Low 1 (Nominal Minus "Mains Failure Alarm 1" Percent of Nominal)
- Phase A Voltage Low 2 (Nominal Minus " Mains Failure Alarm 2" Percent of Nominal)
- Phase A Voltage High 1 (Nominal Plus " Mains Failure Alarm 1" Percent of Nominal)
- Phase A Voltage High 2 (Nominal Plus "V Mains Failure Alarm 2" Percent of Nominal)

Phase A used in the example above, Phase B and Phase C are similar.

- **AC Power Limit Mode:** Sets the rectifier AC Power Limit Mode to “A” or “B” (if supported in the rectifiers). Refer to the rectifier documentation.

- **Turn On when AC Over:** Enables or disables the "Rectifier On at AC Overvoltage" feature. When the system is operating on "weak" grid input power (i.e. diesel generator), the input voltage may have a very high peak voltage which may cause a rectifier not to turn on. If "Rectifier On at AC Overvoltage" feature is enabled, the rectifier is forced to turn on.
- **Input Current Limit:** Sets the Input Current Limit point for all rectifiers.
- **MixHE Power:** Allows the system to use rectifiers of different output capacity. When set to derated power, the output capacity of the higher capacity rectifiers are set to the capacity of the lowest.
- **Diesel Generator Power Limit:** Enables or disables the Diesel Generator Power Limit feature. This feature limits rectifier output power to a percentage of maximum when AC input is supplied by a diesel-alternator set. When enabled, the following parameters can be set.

**Diesel Generator Digital Input:** Sets the digital input monitoring the grid.

**Diesel Gen Power Limit Point:** Sets, as a percentage, the maximum output power at which rectifiers can operate when: 1. the Diesel Power Limit feature is enabled and 2. a digital input signal is received from the connected diesel-alternator set.

- **Rectifier Trim:** Temporarily sets the output voltage for all rectifiers when the controller is in Manual mode. Voltage can be increased or decreased from the existing Float Charge or Equalize Charge setting, depending which mode the controller was in when set to "Manual". Setting reverts to original when controller is returned to the Auto mode.
- **DC On/Off Control:** Temporarily turns the DC output on or off for all rectifiers when the controller is in Manual mode. Setting returns to original when controller is returned to the Auto mode.
- **AC On/Off Control:** Temporarily turns the AC input on or off for all rectifiers when the controller is in Manual mode. Setting returns to original when controller is returned to the Auto mode.
- **Rectifiers LED Control:** Temporarily sets whether or not a rectifier's local power indicator blinks when the controller is communicating with the rectifier when the controller is in Manual mode. Setting returns to original when controller is returned to the Auto mode.
- **Fan Speed Control:** Sets the fan speed for all rectifiers.
- **Confirm Rectifier ID/Feed:** After changing rectifier ID and/or input feed assignments, use this menu item to confirm the change. The only selection is Yes. Once Yes is selected and confirmed, the ID and feed setting of all rectifiers are updated.
- **Reset Rectifier IDs:** Resets the rectifier IDs after they have been previously changed and confirmed. The only selection is Yes. Once Yes is selected and confirmed, the controller resets the rectifier IDs by reassigning ID numbers.
- **Clear Cycle Alarm:** Clears a rectifier oscillator alarm. The only selection is Clear. Once Clear is selected and confirmed, the alarm clears.
- **Clear Rectifier Lost Alarm:** Clears a rectifier lost alarm. The only selection is Yes. Once Yes is selected and confirmed, the alarm clears.
- **Clear Rect Comm Fail Alarm:** Clears a rectifier communication fail alarm. The only selection is Yes. Once Yes is selected and confirmed, the alarm clears.
- **Rectifier Upgrade:** Enables or disables upgrading the firmware in the rectifiers. When enabled, the following parameter can be set.
- **Normal Update:** When "Yes" is selected, updates the rectifiers firmware. See "Upgrading the Rectifiers Firmware" on page 45.

## **DC/DC Converters Tab Programmable Parameter Descriptions**

- **Output Voltage:** Sets the output voltage for all converters.
- **Current Limit:** Enables or disables adjusting the output current limit point. When enabled, the following parameters can be set.
 

**Current Limit Point:** Sets the output current limit point for all converters combined when the “Current Limit” setting above is set to enabled.
- **HVSD:** Enables or disables the High Voltage Shutdown feature for all converters. When enabled, the following parameters can be set.
 

**HVSD Limit:** Sets the High Voltage Shutdown point for all converters when the “HVSD” setting above is set to enabled.
- **Under Voltage:** Sets the converter Under Voltage alarm point.
- **Over Voltage:** Sets the converter Over Voltage alarm point.
- **Over Current:** Sets the converter Over Current alarm point.
- **Converter Trim(24V):** Temporarily sets the output voltage for all converters when the controller is in Manual mode. Setting returns to original when controller is returned to the Auto mode.
- **Converters LED Control:** Temporarily sets whether or not a converter’s local power indicator blinks when the controller is communicating with the converter when the controller is in Manual mode. Setting returns to original when controller is returned to the Auto mode.
- **Fan Speed Control:** Sets the fan speed for all converters.
- **Confirm Converter ID:** After changing converter ID assignments, use this menu item to confirm the change. The only selection is Yes. Once Yes is selected and confirmed, the ID setting of all converters is updated.
- **Reset Converter IDs:** Resets the converter IDs after they have been previously changed and confirmed. The only selection is Yes. Once Yes is selected and confirmed, the controller resets the converter IDs by reassigning ID numbers.
- **Clear Converter Lost Alarm:** Clears a converter lost alarm. The only selection is Yes. Once Yes is selected and confirmed, the alarm clears.
- **Clear All Converters Comm Fail:** Clears an “All Converter Comm Fail” alarm. The only selection is Yes. Once Yes is selected and confirmed, the alarm clears.
- **Clear Converter Comm Fail:** Clears all “Converter Comm Fail” alarms. The only selection is Yes. Once Yes is selected and confirmed, the alarm(s) clears.

## **Solar Tab Programmable Parameter Descriptions**

- **Solar Converter Current Limit:** Sets the output current limit point for all solar converters combined.



**NOTE!** Can only be made when the controller is in the “manual control” state. If the controller is set for “automatic” control, change the “Auto/Manual State” setting first to the “Manual” setting.

- **HVSD Limit:** Sets the High Voltage Shutdown point for all solar converters.
- **Restart on HVSD:** Enables or disables the High Voltage Shutdown Restart feature for all solar converters. When enabled, the following parameters can be set.

**HVSD Restart Time:** When the High Voltage Shutdown Restart feature is enabled and the output exceeds the high voltage limit, the solar converters restart after this time period expires.

- **Walk-In:** Enables or disables the start-up walk-in feature for all solar converters. When enabled, the following parameters can be set.

**Walk- In Time:** Sets the start-up walk-in time when the “Walk-In” setting above is set to enabled.

- **Sequence Start Interval:** Sets the sequence start interval (time period between starting each solar converter in the system).
- **Solar Failure Time:** The time before a “Solar Communication Failure” alarm occurs. Adjustable from 0 to 7 days with default setting of 3 days. A “0” setting sets a Solar Communication Failure alarm to occur immediately after the event occurs.
- **Solar Converter Trim:** Temporarily sets the output voltage for all solar converters when the controller is in Manual mode. Voltage can be increased or decreased from the existing Float Charge or Equalize Charge setting, depending which mode the controller was in when set to "Manual". Setting reverts to original when controller is returned to the Auto mode.
- **DC On/Off Control:** Temporarily turns the DC output on or off for all solar converters when the controller is in Manual mode. Setting returns to original when controller is returned to the Auto mode.
- **Solar Converter LED Control:** Temporarily sets whether or not a solar converter’s local power indicator blinks when the controller is communicating with the solar converter when the controller is in Manual mode. Setting returns to original when controller is returned to the Auto mode.
- **Fan Speed Control:** Sets the fan speed for all solar converters.
- **Confirm Solar Converter ID:** After changing solar converter ID assignments, use this menu item to confirm the change. The only selection is Yes. Once Yes is selected and confirmed, the ID setting of all solar converters is updated.
- **Reset Solar Converter IDs:** Resets the solar converter IDs after they have been previously changed and confirmed. The only selection is Yes. Once Yes is selected and confirmed, the controller resets the solar converter IDs by reassigning ID numbers.
- **Clear Solar Converter Comm Fail:** Clears a solar converter communication fail alarm. The only selection is Yes. Once Yes is selected and confirmed, the alarm clears.
- **Clear Solar Converter Lost Alarm:** Clears a solar converter lost alarm. The only selection is Yes. Once Yes is selected and confirmed, the alarm clears.

### **Battery Test Tab Programmable Parameter Descriptions**

- **Battery Test Control:** Starts or stops battery test.
- **AC Fail Test:** Enables or disables starting a battery discharge test during an AC input failure condition.
- **Constant Current Test:** Enables or disables a Constant Current Battery Discharge Test. During this test, the controller automatically adjusts the rectifiers' output voltage to maintain the battery discharge current at a preset value (Constant Current Test Current). When enabled, the following parameters can be set.

**Constant Current Test Current:** Constant current setting for a Constant Current Battery Discharge Test.

- **Short Test:** Enables or disables a Short Battery Discharge Test. A Short Battery Discharge Test is a short duration battery discharge test used to verify that parallel batteries are discharging equally. If the discharge current difference between the two batteries exceeds a preset value, an alarm is generated. When enabled, the following parameters can be set.



**NOTE!** *This test requires a system with two battery shunts.*

**Short Test Cycle:** Short Battery Discharge Test interval (days).

**Short Test Time:** Short Battery Discharge Test time (minutes).

**Short Test Max Difference Current:** An alarm is generated if the maximum difference between discharge currents of the two batteries exceeds this limit.

- **Test Voltage Level:** System output voltage setting during a battery discharge test.
- **End Test Voltage:** This is the "end of test voltage level" for battery discharge tests. A battery discharge test will end if battery voltage decreases to this setting.
- **End Test Time:** This is the "end of test time period" for battery discharge tests. A battery discharge test will end if this time period is exceeded.
- **End Test Capacity:** This is the "end of test remaining battery capacity" for battery discharge tests. A battery discharge test will end if remaining battery capacity decreases to this setting. For example, a value of 0.700C10 means that when the discharging current reaches 70% of the battery's nominal capacity, the battery test is ended.
- **Record Threshold:** Every time the battery voltage is changed more than this threshold, a new line is stored in the battery test log.
- **Number of Planned Tests per Year:** Number of planned battery discharge test per year. There can be up to twelve (12) battery discharge tests per year. A "0" setting disables the planned test feature. When enabled, the following parameters can be set.

**Planned Test # (MM-DD Hr):** Setting for when planned battery discharge test # occurs. Note that there can be up to twelve (12) battery discharge tests per year.

- **Clear Bad Battery Alarm:** Clears a bad battery alarm. The only selection is Yes. Once Yes is selected and confirmed, the alarm clears.
- **Clear Battery Test Fail Alarm:** Clears a battery test fail alarm. The only selection is Yes. Once Yes is selected and confirmed, the alarm clears.
- **Clear Discharge Curr Imbalance:** Clears a discharge current imbalance alarm. The only selection is Yes. Once Yes is selected and confirmed, the alarm clears.

### **Time Settings Tab Programmable Parameter Descriptions**

See also "Changing the Date and Time" on page 27.

- **Specify Time**
  - **Get Local Time from Connected PC:** Allows you to automatically set the time. When selected, the controller will get the same time as the connected PC.
  - **Date & Time:** Allows you to manually set the date and time.
- **Local Zone (for synchronization with time servers):** When selected, the controller will get the local zone automatically or you can enter the zone.
- **Get time automatically from the following servers.**
  - When selected, the controller will get the time from the selected time server. The controller will also adjust the time per the "Local Zone" setting.

## **Inverters Tab Programmable Parameter Descriptions**

- **DC Low Voltage Off:** Low output voltage threshold the inverter will turn off.
- **DC Low Voltage On:** Low output voltage threshold the inverter will turn on.
- **DC High Voltage Off:** High output voltage threshold the inverter will turn off.
- **DC High Voltage On:** High output voltage threshold the inverter will turn on.
- **Primary Input Power:** Sets the input mode of operation (AC Mode, DC Mode, DC Only).
- **Output On/Off Control:** Turns output On/Off to all inverters to check/set the “Output Voltage Level” and “Output Frequency”.
- **LED Control:** Temporarily sets whether or not an inverter’s local power indicator blinks when the controller is communicating with the inverter when the controller is in Manual mode. Setting returns to original when controller is returned to the Auto mode.
- **Fan Speed Control:** Sets the fan speed for all inverters.
- **Confirm Inverter ID/Feed:** After changing inverter ID and/or input feed assignments, use this menu item to confirm the change. The only selection is Yes. Once Yes is selected and confirmed, the ID and feed setting of all inverters are updated.
- **Reset Inverter IDs:** Resets the inverter IDs after they have been previously changed and confirmed. The only selection is Yes. Once Yes is selected and confirmed, the controller resets the inverter IDs by reassigning ID numbers.
- **Clear Inverter Lost Alarm:** Clears an inverter lost alarm. The only selection is Yes. Once Yes is selected and confirmed, the alarm clears.
- **Clear Inverter Comm Fail Alarm:** Clears an inverter communication fail alarm. The only selection is Yes. Once Yes is selected and confirmed, the alarm clears.
- **Clear All Invt Comm Fail Alarm:** Clears all inverter communication fail alarms. The only selection is Yes. Once Yes is selected and confirmed, all alarms clear.
- **Clear Fault:** Clears an inverter fault alarm. The only selection is Yes. Once Yes is selected and confirmed, the alarm clears.
- **Inverter Upgrade:** Enables or disables upgrading the firmware in the inverters.
- **Normal Update:** When “Yes” is selected, updates the inverters’ firmware. See “Upgrading the Inverters Firmware” on page 45.

## 5.9.2 History Log Menu

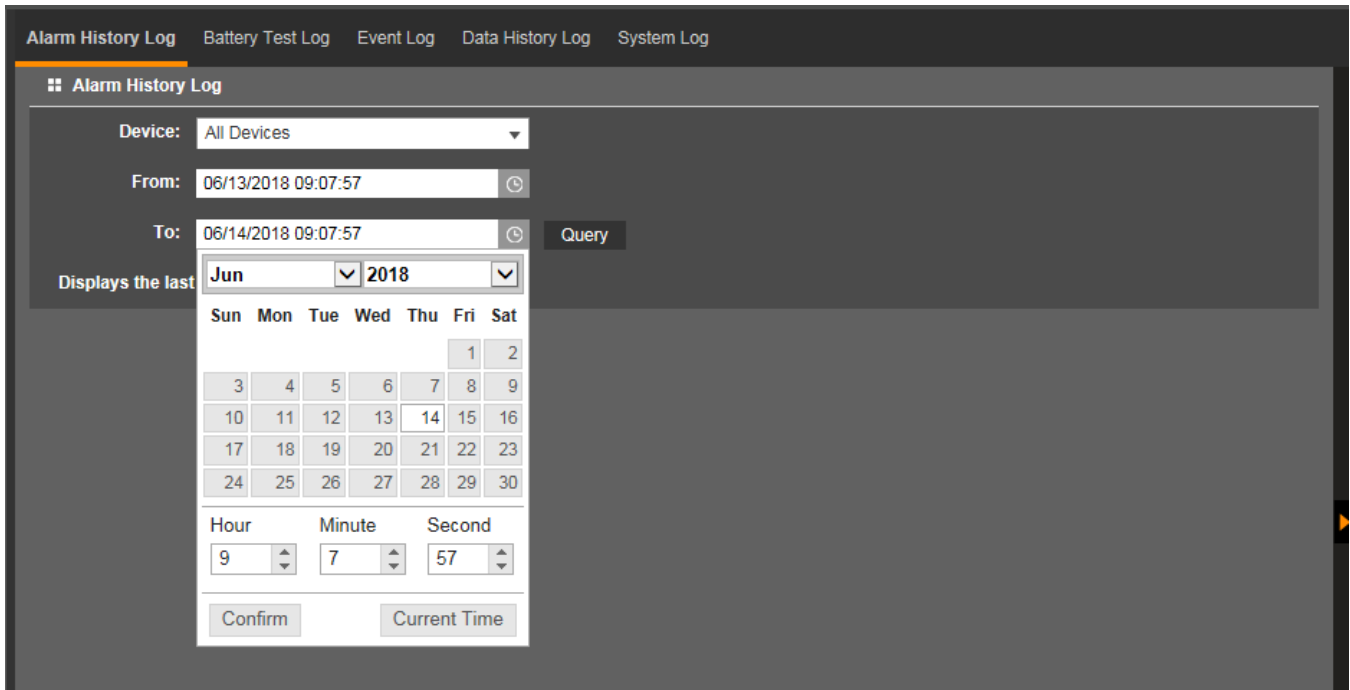
The History Log Menu allows you to view and save the various logs available in the controller.

### Alarm History Log Tab

#### Select Device and Time

Select the "Device" to query from the drop-down list box. Select the "from" and "to" time.

Figure 5.46 Alarm History Log Device and Time Selection





### Query Alarm History Log

Click “Query” to query for alarms within selected time slot. The Web page displays the last 500 entries.

Figure 5.47 Alarm History Log Query

Index	Device Name	Signal Name	Alarm Level	Start Time	End Time
1	SMDU1 DC Fuse	Fuse 5 Alarm	CR	06/11/2018 11:26:18	06/12/2018 14:06:41
2	SMDU1 DC Fuse	Fuse 4 Alarm	CR	06/11/2018 11:26:18	06/12/2018 14:06:37
3	SMDU1 DC Fuse	Fuse 3 Alarm	CR	06/11/2018 11:26:18	06/12/2018 14:06:33
4	SMDU1 DC Fuse	Fuse 2 Alarm	CR	06/11/2018 11:26:18	06/12/2018 14:06:27
5	SMDU1 DC Fuse	Fuse 1 Alarm	CR	06/11/2018 11:26:18	06/12/2018 14:06:23
6	DC Fuse Unit	Fuse 8 Alarm	CR	05/29/2018 09:49:55	06/12/2018 14:05:17
7	DC Fuse Unit	Fuse 7 Alarm	CR	05/29/2018 09:49:55	06/12/2018 14:05:12
8	DC Fuse Unit	Fuse 5 Alarm	CR	05/29/2018 09:49:55	06/12/2018 14:05:01
9	DC Fuse Unit	Fuse 4 Alarm	CR	05/29/2018 09:49:55	06/12/2018 14:04:54
10	DC Fuse Unit	Fuse 3 Alarm	CR	05/29/2018 09:49:55	06/12/2018 14:04:07
11	DC Fuse Unit	Fuse 2 Alarm	CR	05/29/2018 09:49:55	06/12/2018 14:03:56
12	DC Fuse Unit	Fuse 1 Alarm	CR	05/29/2018 09:49:55	06/12/2018 14:03:46
13	IB2-1	DI3	CR	06/12/2018 13:30:22	06/12/2018 13:31:00
14	IB2-1	DI2	CR	06/11/2018 11:26:18	06/12/2018 13:22:09

### Upload Alarm History Log

Click “Upload” to open the log into another window. You can then save the log as an .html (Web page) or .txt (text) file.

Figure 5.48 Alarm History Log Upload

Query Alarm History Log  
 Query EquipID: All Devices  
 Query Time: from 04-01-2018 09:07:57 to 06-14-2018 09:07:57  
 Total 56 alarm(s) queried.

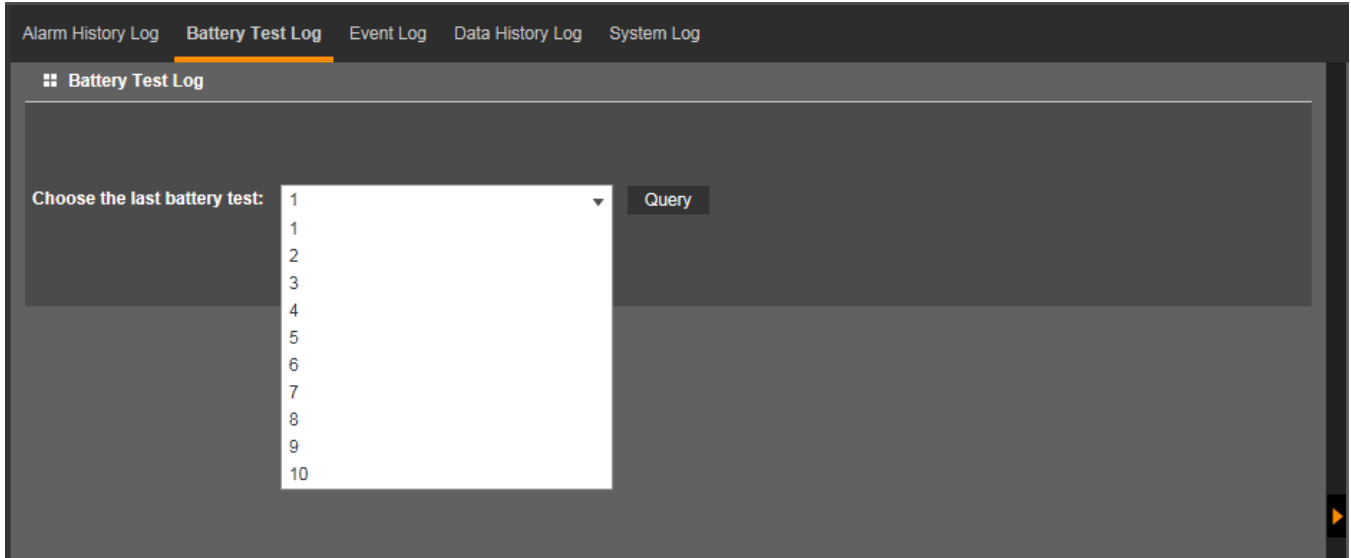
Index	Device Name	Signal Name	Alarm Level	Start Time	End Time
1	SMDU1 DC Fuse	Fuse 5 Alarm	CA	06-11-2018 11:26:18	06-12-2018 14:06:41
2	SMDU1 DC Fuse	Fuse 4 Alarm	CA	06-11-2018 11:26:18	06-12-2018 14:06:37
3	SMDU1 DC Fuse	Fuse 3 Alarm	CA	06-11-2018 11:26:18	06-12-2018 14:06:33
4	SMDU1 DC Fuse	Fuse 2 Alarm	CA	06-11-2018 11:26:18	06-12-2018 14:06:27
5	SMDU1 DC Fuse	Fuse 1 Alarm	CA	06-11-2018 11:26:18	06-12-2018 14:06:23
6	DC Fuse Unit	Fuse 8 Alarm	CA	05-29-2018 09:49:55	06-12-2018 14:05:17
7	DC Fuse Unit	Fuse 7 Alarm	CA	05-29-2018 09:49:55	06-12-2018 14:05:12
8	DC Fuse Unit	Fuse 5 Alarm	CA	05-29-2018 09:49:55	06-12-2018 14:05:01
9	DC Fuse Unit	Fuse 4 Alarm	CA	05-29-2018 09:49:55	06-12-2018 14:04:54
10	DC Fuse Unit	Fuse 3 Alarm	CA	05-29-2018 09:49:55	06-12-2018 14:04:07
11	DC Fuse Unit	Fuse 2 Alarm	CA	05-29-2018 09:49:55	06-12-2018 14:03:56
12	DC Fuse Unit	Fuse 1 Alarm	CA	05-29-2018 09:49:55	06-12-2018 14:03:46
13	IB2-1	DI3	CA	06-12-2018 13:30:22	06-12-2018 13:31:00
14	IB2-1	DI2	CA	06-11-2018 11:26:18	06-12-2018 13:22:09
15	IB2-1	DI1	CA	06-11-2018 11:26:18	06-12-2018 13:21:55
16	Converter Group	All Converters Comm Fail	CA	05-29-2018 10:01:03	05-29-2018 10:01:05

## Battery Test Log Tab

### Select Battery Test Number

Select the Battery Test Log to query from the drop-down list box. Battery test #1 is the most recent.

Figure 5.49 Battery Test Log Number Selection



### Query Selected Battery Test

Click “Query” to query the selected battery test. The Web page displays up to ten (10) battery tests.



**NOTE!** Battery tests in which battery voltage changed less than the Record Threshold setting are not recorded.

Figure 5.50 Battery Test Log Query

Start Time	End Time	Start Reason	End Reason	Test Result
05/22/2018 11:11:03	05/22/2018 12:51:13	Start Manual Test	End Test for Test Time-Out	Battery is OK

Index	Record Time	System Voltage(V)	Battery1 Current(A)	Battery1 Voltage(V)	Battery1 Capacity(Ah)
1	05/22/2018 11:11:03	53.99	0	54	50
2	05/22/2018 11:11:33	50.24	-8.77	50.06	50
3	05/22/2018 11:11:43	50.01	-11.59	49.9	50
4	05/22/2018 11:11:53	49.85	-11.89	49.81	50
5	05/22/2018 11:12:03	49.45	-15.33	49.09	50
6	05/22/2018 11:12:13	49	-21.08	48.93	50
7	05/22/2018 11:12:23	48.89	-22.74	48.84	50
8	05/22/2018 11:12:43	48.73	-24.4	48.65	50
9	05/22/2018 11:12:53	48.62	-24.51	48.62	49
10	05/22/2018 11:13:23	48.51	-24.56	48.5	49

### Upload Battery Test Log

Click “Upload” to open the log into another window. You can then save the log as an .html (Web page) or .txt (text) file.

Figure 5.51 Battery Test Log Upload

Query Battery Test Log  
 Start time: 05-22-2018 11:11:03  
 End time: 05-22-2018 12:51:13  
 Start reason: Start Manual Test  
 End reason: End Test for Test Time-Out  
 Test result: Battery is OK

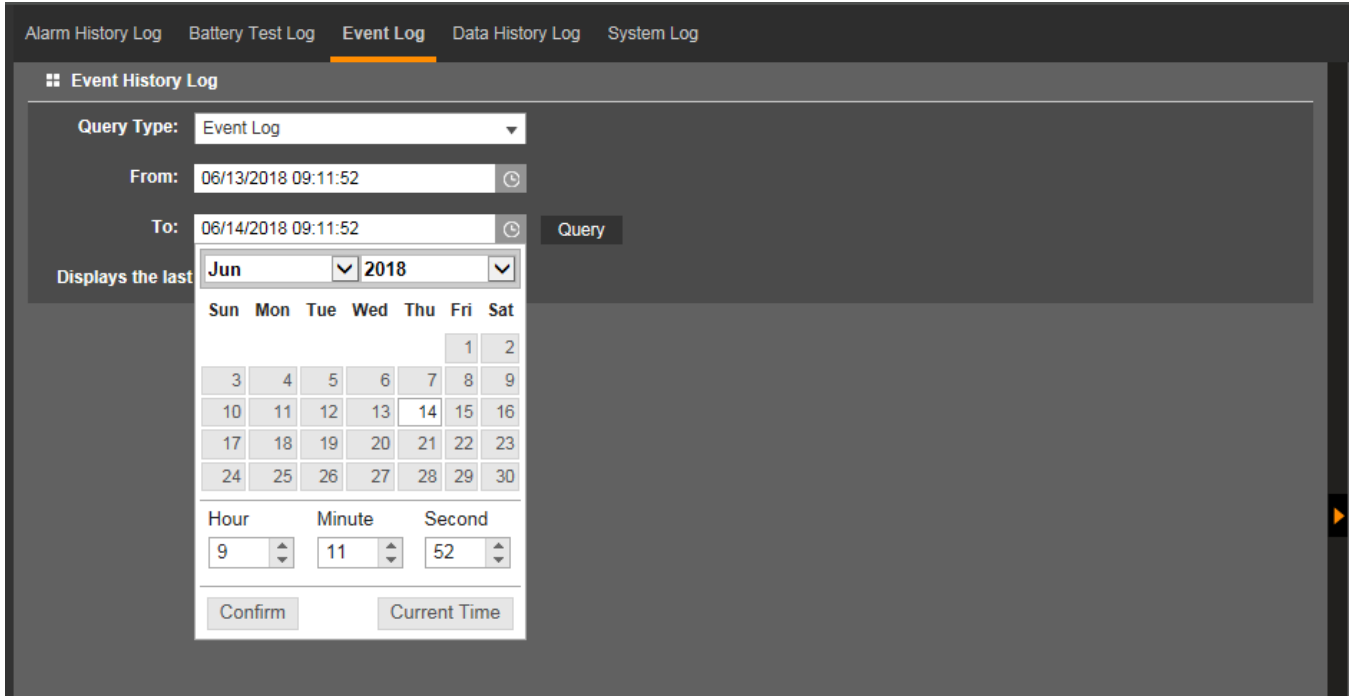
Index	Record Time	System Voltage(V)	Battery1 Current(A)	Battery1 Voltage(V)	Battery1 Capacity(Ah)
1	05-22-2018 11:11:03	53.99	0.00	54.00	50
2	05-22-2018 11:11:33	50.24	-8.77	50.06	50
3	05-22-2018 11:11:43	50.01	-11.59	49.90	50
4	05-22-2018 11:11:53	49.85	-11.89	49.81	50
5	05-22-2018 11:12:03	49.45	-15.33	49.09	50
6	05-22-2018 11:12:13	49.00	-21.08	48.93	50
7	05-22-2018 11:12:23	48.89	-22.74	48.84	50
8	05-22-2018 11:12:43	48.73	-24.40	48.65	50
9	05-22-2018 11:12:53	48.62	-24.51	48.62	49
10	05-22-2018 11:13:23	48.51	-24.56	48.50	49
11	05-22-2018 11:14:02	48.41	-24.63	48.43	49
12	05-22-2018 11:16:33	48.29	-25.86	48.31	48

## Event Log Tab

### Select Time

Select the "from" and "to" time.

Figure 5.52 Event Log Time Selection



### Query Event Log

Click “Query” to query the Event Log. The Web page displays the last 500 entries.

Figure 5.53 Event Log Query

The screenshot shows a web interface for the Event History Log. At the top, there are navigation tabs: Alarm History Log, Battery Test Log, Event Log (selected), Data History Log, and System Log. Below the tabs is a section titled "Event History Log" containing a query form. The form has a "Query Type" dropdown set to "Event Log", a "From" date field set to "04/01/2018 09:11:52", and a "To" date field set to "06/14/2018 09:11:52". There are "Query" and "Upload" buttons. Below the form, it says "Displays the last 500 entries!". A table follows with columns: Index, Device Name, Signal Name, Value, Unit, Time, Sender Name, and Sender Type. The table contains 11 rows of data.

Index	Device Name	Signal Name	Value	Unit	Time	Sender Name	Sender Type
1	Rectifier Group	ECO Mode	Disabled	--	06/14/2018 08:59:06	WEB: ADMIN	User
2	Rectifier Group	ECO Mode	Enabled	--	06/14/2018 08:58:20	WEB: ADMIN	User
3	Power System	Time Display Format	MM/DD/YYYY	--	06/12/2018 13:38:01	WEB: admin	User
4	Power System	Temperature Format	Fahrenheit	--	06/12/2018 13:36:17	WEB: admin	User
5	Power System	NTP Function Enable	Disabled	--	06/12/2018 13:35:16	Web:admin	User
6	Power System	NTP Function Enable	Disabled	--	06/12/2018 13:34:08	Web:admin	User
7	Power System	NTP Function Enable	Disabled	--	06/12/2018 13:34:01	Web:admin	User
8	Battery 1	Rated Capacity	50.00	Ah	05/29/2018 09:58:51	WEB: admin	User
9	Battery 1	Rated Capacity	75.00	Ah	05/29/2018 09:58:30	WEB: admin	User
10	Battery 1	Rated Capacity	100.00	Ah	05/29/2018 09:58:14	WEB: admin	User
11	Battery 1	Rated Capacity	150.00	Ah	05/29/2018 09:57:44	WEB: admin	User

### Upload Event Log

Click “Upload” to open the log into another window. You can then save the log as an .html (Web page) or .txt (text) file.

Figure 5.54 Event Log Upload

The screenshot shows a web page titled "Query Event Log" with the query time "from 04-01-2018 09:11:52 to 06-14-2018 09:11:52" and "Total 46 record(s) queried." Below this is a table with columns: Index, Device Name, Signal Name, Value, Unit, Time, Sender Name, and Sender Type. The table contains 17 rows of data.

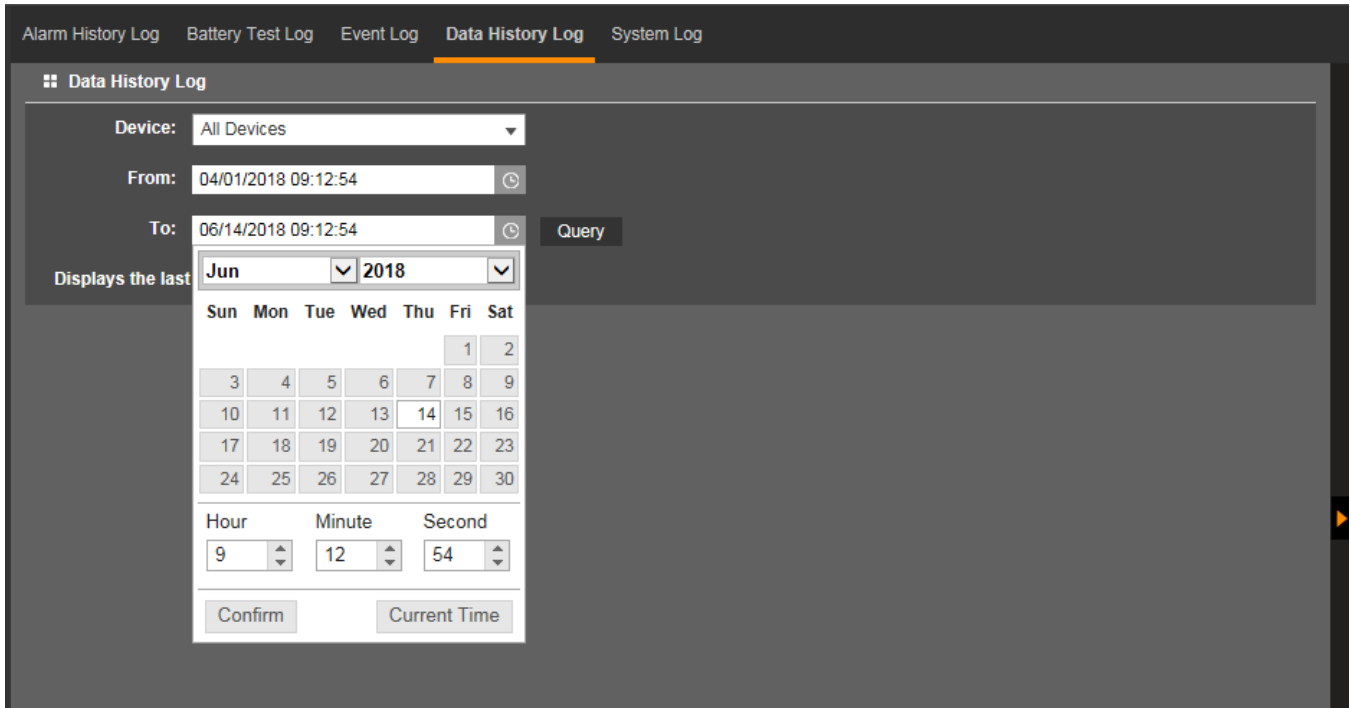
Index	Device Name	Signal Name	Value	Unit	Time	Sender Name	Sender Type
1	Rectifier Group	ECO Mode	Disabled	--	06-14-2018 08:59:06	WEB: ADMIN	User
2	Rectifier Group	ECO Mode	Enabled	--	06-14-2018 08:58:20	WEB: ADMIN	User
3	Power System	Time Display Format	MM/DD/YYYY	--	06-12-2018 13:38:01	WEB: admin	User
4	Power System	Temperature Format	Fahrenheit	--	06-12-2018 13:36:17	WEB: admin	User
5	Power System	NTP Function Enable	Disabled	--	06-12-2018 13:35:16	Web:admin	User
6	Power System	NTP Function Enable	Disabled	--	06-12-2018 13:34:08	Web:admin	User
7	Power System	NTP Function Enable	Disabled	--	06-12-2018 13:34:01	Web:admin	User
8	Battery 1	Rated Capacity	50.00	Ah	05-29-2018 09:58:51	WEB: admin	User
9	Battery 1	Rated Capacity	75.00	Ah	05-29-2018 09:58:30	WEB: admin	User
10	Battery 1	Rated Capacity	100.00	Ah	05-29-2018 09:58:14	WEB: admin	User
11	Battery 1	Rated Capacity	150.00	Ah	05-29-2018 09:57:44	WEB: admin	User
12	Battery 1	Rated Capacity	175.00	Ah	05-29-2018 09:57:25	WEB: admin	User
13	Battery 1	Rated Capacity	200.00	Ah	05-29-2018 09:57:02	WEB: admin	User
14	Battery 1	Rated Capacity	10000.00	Ah	05-29-2018 09:55:28	WEB: admin	User
15	Battery 1	Rated Capacity	150.00	Ah	05-29-2018 09:55:03	WEB: admin	User
16	Battery 1	Rated Capacity	200.00	Ah	05-29-2018 09:54:40	WEB: admin	User
17	Battery 1	Rated Capacity	100.00	Ah	05-29-2018 09:54:10	WEB: admin	User

## Data History Log Tab

### Select Device and Time

Select the "Device" to query from the drop-down list box. Select the "from" and "to" time.

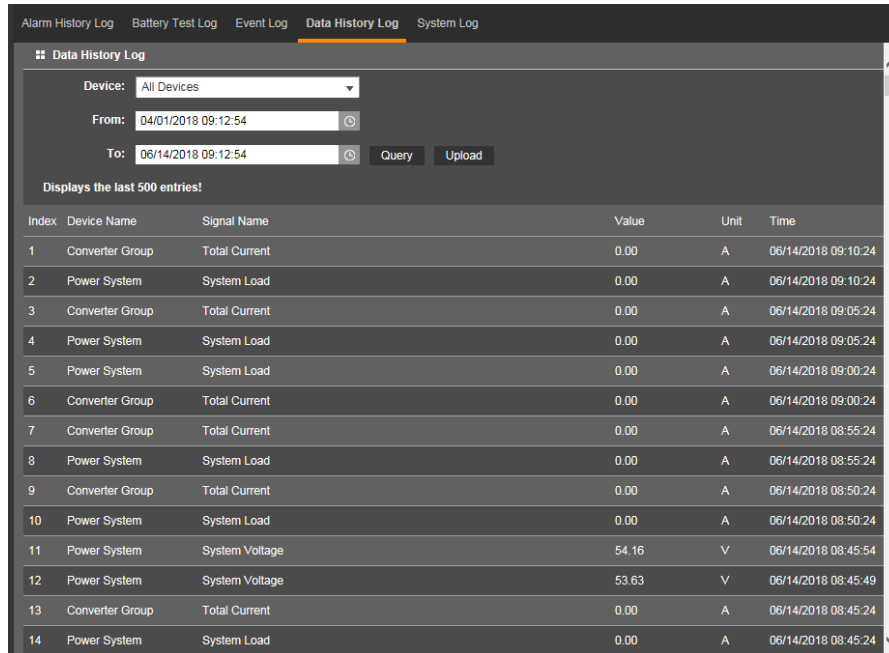
Figure 5.55 Data History Log Device and Time



### Query Data History Log

Click “Query” to query for Date History within selected time slot. The Web page displays the last 500 entries.

Figure 5.56 Data History Log Query



### Upload Data History Log

Click “Upload” to open the log into another window. You can then save the log as an .html (Web page) or .txt (text) file.

Figure 5.57 Data History Log Upload

Query Data History Log  
 Query EquipID: All Devices  
 Query Time: from 04-01-2018 09:12:54 to 06-14-2018 09:12:54  
 Total 4741 record(s) queried.

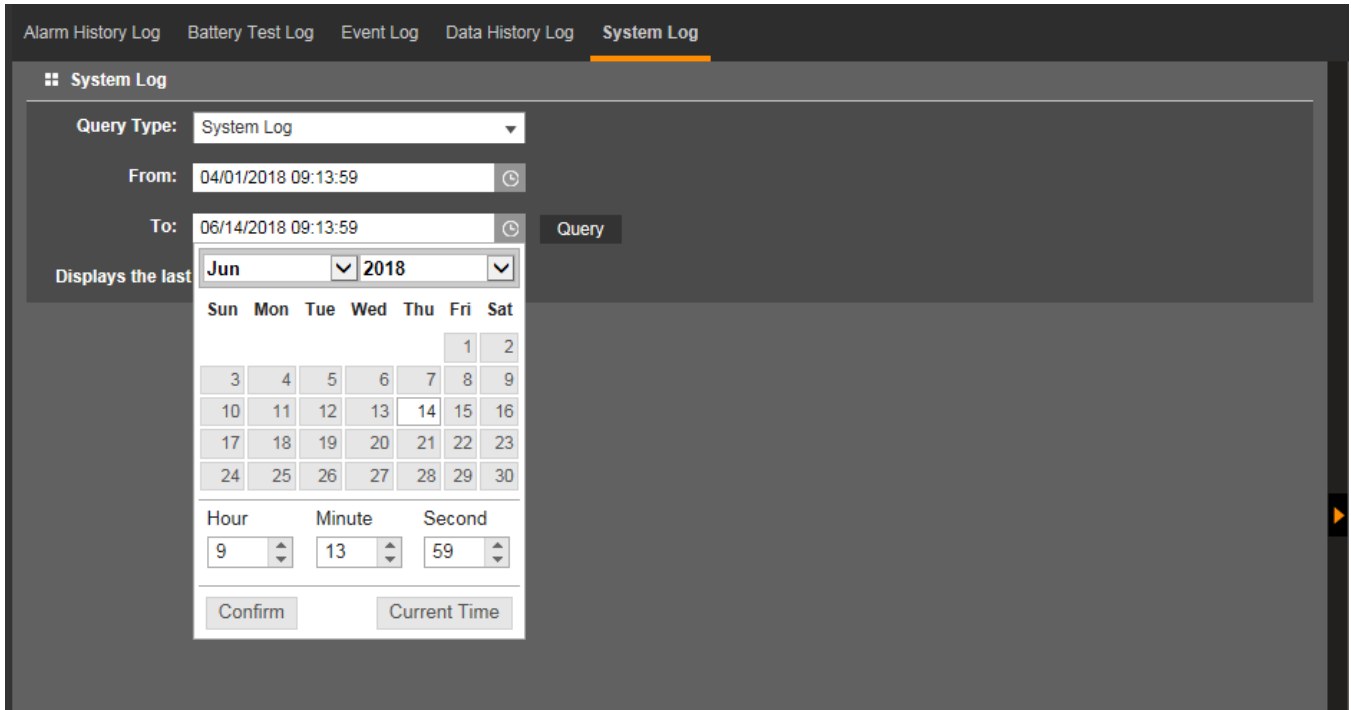
Index	Device Name	Signal Name	Value	Unit	Time
1	Converter Group	Total Current	0.00	A	06-14-2018 09:10:24
2	Power System	System Load	0.00	A	06-14-2018 09:10:24
3	Converter Group	Total Current	0.00	A	06-14-2018 09:05:24
4	Power System	System Load	0.00	A	06-14-2018 09:05:24
5	Power System	System Load	0.00	A	06-14-2018 09:00:24
6	Converter Group	Total Current	0.00	A	06-14-2018 09:00:24
7	Converter Group	Total Current	0.00	A	06-14-2018 08:55:24
8	Power System	System Load	0.00	A	06-14-2018 08:55:24
9	Converter Group	Total Current	0.00	A	06-14-2018 08:50:24
10	Power System	System Load	0.00	A	06-14-2018 08:50:24
11	Power System	System Voltage	54.16	V	06-14-2018 08:45:54
12	Power System	System Voltage	53.63	V	06-14-2018 08:45:49
13	Converter Group	Total Current	0.00	A	06-14-2018 08:45:24
14	Power System	System Load	0.00	A	06-14-2018 08:45:24
15	Converter Group	Total Current	0.00	A	06-14-2018 08:40:24
16	Power System	System Load	0.00	A	06-14-2018 08:40:24
17	Converter Group	Total Current	0.00	A	06-14-2018 08:35:24
18	Power System	System Load	0.00	A	06-14-2018 08:35:24
19	Converter Group	Total Current	0.00	A	06-14-2018 08:30:20
20	Power System	System Load	0.00	A	06-14-2018 08:30:20

## System Log Tab

### Select Time

Select the "from" and "to" time.

Figure 5.58 System Log Time Selection





## Query System Log

Click “Query” to query the System Log. The Web page displays the last 500 entries.

Figure 5.59 System Log Query

Index	Task Name	Info Level	Time	Information
1	SERVICE_MGR	DEBUG	06-12-2018 13:05:52	MAIN_THREAD : #8 service 'SMS' is loaded OK. Lib=0x7bfc30, Main=0x4889151c.
2	SERVICE_MGR	DEBUG	06-12-2018 13:05:52	MAIN_THREAD : Starting #9 service 'MAIL'(mail.so)...
3	SERVICE_MGR	DEBUG	06-12-2018 13:05:58	MAIN_THREAD : Starting service 'MAIL'(mail.so)...
4	SERVICE_MGR	DEBUG	06-12-2018 13:05:58	MAIN_THREAD : Service [MAIL] started as task. tid=0x11000f.
5	SERVICE_MGR	DEBUG	06-12-2018 13:05:58	MAIN_THREAD : #9 service 'MAIL' is loaded OK. Lib=0x7c1f18, Main=0x490a3b08.
6	SERVICE_MGR	DEBUG	06-12-2018 13:05:58	MAIN_THREAD : Starting #10 service 'MODBUS_MAIN'(modbus.so)...
7	SERVICE_MGR	DEBUG	06-12-2018 13:06:00	MAIN_THREAD : Starting MODBUS_MAIN service after MAIL init finished
8	SERVICE_MGR	DEBUG	06-12-2018 13:06:00	MAIN_THREAD : Starting service 'MODBUS_MAIN'(modbus.so)...
9	SERVICE_MGR	DEBUG	06-12-2018 13:06:00	MAIN_THREAD : Service [MODBUS_MAIN] started as task. tid=0x110010.
10	SERVICE_MGR	DEBUG	06-12-2018 13:06:00	MAIN_THREAD : #10 service 'MODBUS_MAIN' is loaded OK. Lib=0x7c47a8, Main=0x498c1e00.
11	SERVICE_MGR	DEBUG	06-12-2018 13:06:00	MAIN_THREAD : Starting #12 service 'WEB_USER'(web_user.so)...
12	SERVICE_MGR	DEBUG	06-12-2018 13:06:00	MAIN_THREAD : Starting WEB_USER service after MODBUS_MAIN init finished

## Upload System Log

Click “Upload” to open the log into another window. You can then save the log as an .html (Web page) or .txt (text) file.

Figure 5.60 System Log Upload

Query System Log

Query Time: from 04-01-2018 09:13:59 to 06-14-2018 09:13:59

Total 5000 record(s) queried.

Index	Task Name	Info Level	Log Time	Information
1	SERVICE_MGR	DEBUG	05-08-2018 08:44:27	MAIN_THREAD : Stopping #8 service 'SMS'...
2	SERVICE_MGR	DEBUG	05-08-2018 08:44:27	MAIN_THREAD : Stopping #9 service 'MAIL'...
3	SERVICE_MGR	DEBUG	05-08-2018 08:44:27	MAIN_THREAD : Stopping #10 service 'MODBUS_MAIN'...
4	SERVICE_MGR	DEBUG	05-08-2018 08:44:27	MAIN_THREAD : Stopping #12 service 'WEB_USER'...
5	GEN CTRL	INFO	05-08-2018 08:44:28	GEN_CTRL : *** The General Controller service exit! ***
6	SERVICE_MGR	DEBUG	05-08-2018 08:44:28	MAIN_THREAD : The service 'GEN_CTRL' exited with code 0.
7	SERVICE_MGR	DEBUG	05-08-2018 08:44:28	MAIN_THREAD : The service 'QT_FIFO' exited with code 0.
8	SERVICE_MGR	DEBUG	05-08-2018 08:44:28	MAIN_THREAD : The service 'WEB_UI' exited with code 0.
9	SERVICE_MGR	DEBUG	05-08-2018 08:44:28	MAIN_THREAD : The service 'SNMP_MAIN' exited with code 201326594.
10	SERVICE_MGR	DEBUG	05-08-2018 08:44:28	MAIN_THREAD : The service 'PLC' exited with code 0.
11	SERVICE_MGR	DEBUG	05-08-2018 08:44:31	MAIN_THREAD : The service 'SMS' exited with code 0.
12	SERVICE_MGR	DEBUG	05-08-2018 08:44:31	MAIN_THREAD : The service 'MAIL' exited with code 0.
13	SERVICE_MGR	DEBUG	05-08-2018 08:44:34	MAIN_THREAD : The service 'MODBUS_MAIN' exited with code 0.

### 5.9.3 System Inventory Menu

The System Inventory Menu allows you to view product information of the intelligent devices (i.e. rectifiers, converters, SMDUs, IB, SMDUE, etc.) connected to the controller.

Figure 5.61 System Inventory Menu

System Inventory				
System Inventory				
Equipment	Product Model	Hardware Revision	Serial Number	Software Revision
NCU	M830D	A09	03160500583	1.2.00T10
Rectifier #1	1R483500e3	A01	06151100025	1.01
Rectifier #2	1R483500e3	A01	06160500004	9.02
Rectifier #3	1R483500e3	A01	06160500039	9.02
Rectifier #4	1R483500e3	A01	06170900420	10.3
Rectifier #5	1R483500e3	A01	06170900432	10.3
SMDU 1	1SMDU	A02	03151200041	1.23
EIB-1	1MA455U41	A01	03170301358	1.02
IB2-1	1MA4C5U31	A09	03180202264	1.03
SMDUP 1	1SMDU+	A00	03121000039	1.04
SMDUP 2	1SMDU+	A00	03100500014	1.04
Converter #1	C48/241500	A03	03130601273	1.01
Converter #2	C48/241500	A03	03130500202	1.01
Converter #5	C48/241500	A03	03130600435	1.01
SM Temp 1	1SMTEMP	A01	03110300006	2.00

## 5.9.4 Advanced Settings Menu

The Advanced Settings Menu allows you to change (if you have the proper privilege level programmed in your User settings) the settings of the various advanced programmable parameters. Settings are grouped per function. Select a tab in the Advanced Settings Menu to change that functions programmable parameters.

### Ethernet Tab

You can configure the controller's network parameters.

- IPv4: IP Address, Subnet Mask, and Default Gateway.
- IPv6: IPv6 Address, IPv6 Prefix, and IPv6 Gateway.

After modifying the network parameters, click "Save" to validate the change made to the parameters.



**NOTE!** After changing the IP Address, you will need to login again with the new IP address.

Figure 5.62 Ethernet Tab

The screenshot shows the 'Ethernet' configuration page with the following sections:

- IPv4:** IP Address: 10.201.229.44, Subnet Mask: 255.255.255.0, Default Gateway: 10.201.229.1
- IPv4 DHCP:** Server IP: 0.0.0.0 (Save button)
- IPv6:** Link-Local Address: fe80::209:f5ff:fe16:349f / 64, IPv6 Address: ::, Subnet Prefix: 0, Default Gateway: :: (Save button)
- IPv6 DHCP:** Server IP: :: / 0

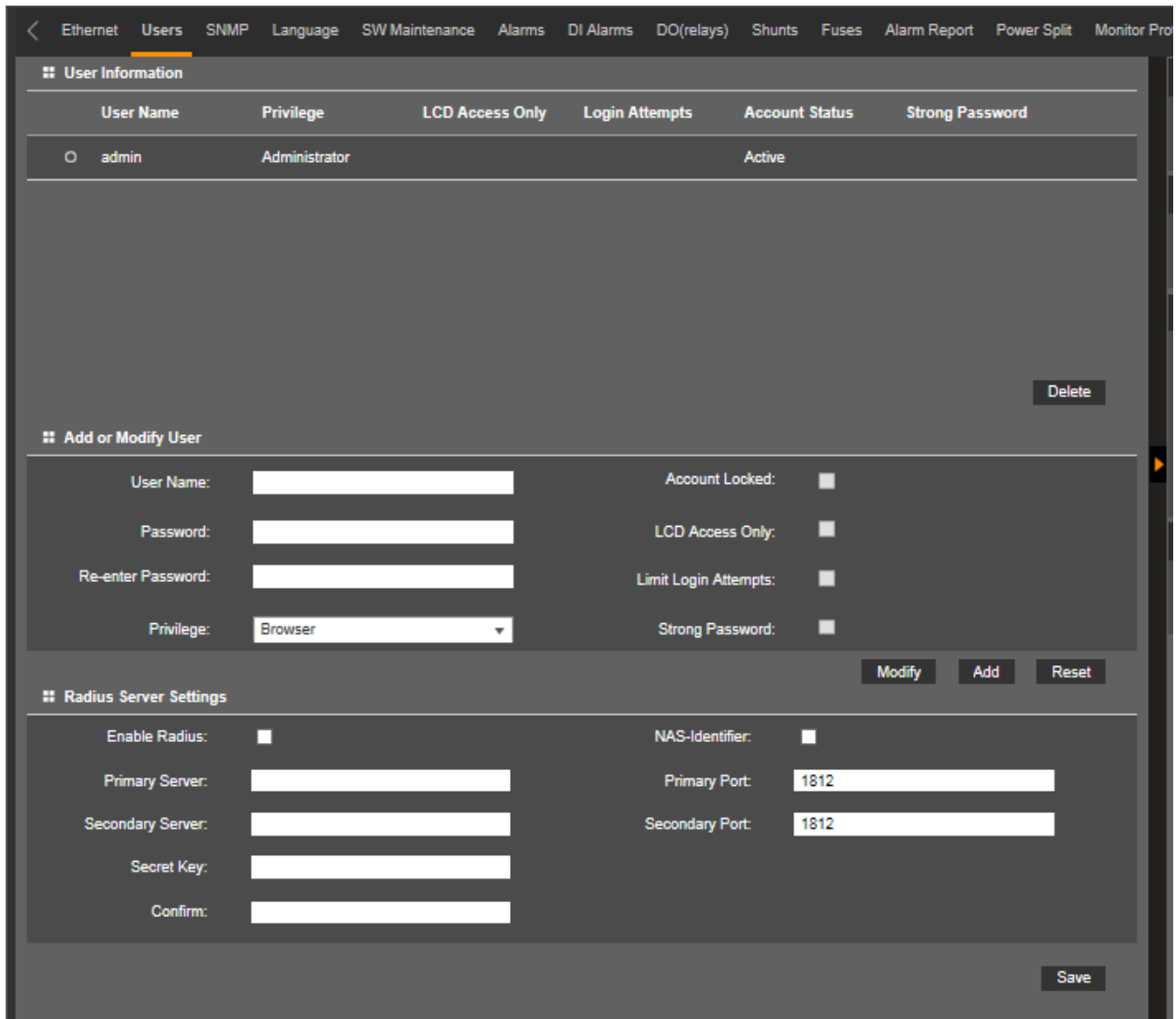
## Users Tab

You can add, edit, and delete Users. These are the Users that can log onto the controller both locally (local display access) or remotely using the Web Interface.

- A maximum of sixteen (16) Users can be set up in the controller.
- A maximum of five (5) Users can access the controller at the same time.

You can also enable the radius server feature (see “Radius Server Feature” on page 16) and enter the radius server parameters.

Figure 5.63 Users Tab



**Adding a User**

1. Enter the User's Name in the "User Name" field.

**User Name:** Eight (8) characters maximum; the valid characters are 0-9, a-z, A-Z, and \_.

2. Enter a password for this User in the "Password" field.

**Password:** Thirteen (13) characters maximum; the valid characters are 0-9, a-z, A-Z, and \_ . Passwords must be at least six (6) characters long.

3. Re-enter the password for this User in the "Re-enter Password" field.

4. Select the privilege of the User from those listed in the "Privilege" drop-down list box. See "Web Interface User Privilege Levels" on page 168 for a description. See also "Passwords and Privilege Levels" on page 19.

5. Check the following boxes as applicable for this User.

- a) Account Locked: An Admin privilege User can check this box to make an Inactive user account Active again. See "Limit Login Attempts" below.
- b) LCD Access Only: When this option is checked, the associated User can only login using the LCD (cannot login via the web).
- c) Limit Login Attempts: When this option is checked, the associated account will be locked and account status will become Inactive after the user crosses 100 failed attempts to login within its Active status duration, the account can be unlocked by an Admin privilege user only using the "Account Locked" checkbox (see "Account Locked" above).
- d) Strong Password: When this option is checked, a strong password will be required for this User. A strong password is at least 16 characters long, and the password should contain at-least one upper case, one lower case alphabet, one numerical and one special character in its password string.

6. Click the "Add" button to add the User.



**NOTE!** To reset the form (i.e. to start over) and erase all information entered, click on the "Reset" button.

**Modifying an Existing User**

1. Select the User to be modified from those listed in the "User Information" list.
2. Modify the parameters of this User.
3. Click the "Modify" button to modify the parameters of this User to the new settings.



**NOTE!** To reset the form (i.e. to start over) and erase all information entered, click on the "Reset" button.

**Deleting a User**

1. Select the User to be deleted from those listed in the "User Information" list.
2. Click the "Delete" button to delete this User.

### Web Interface User Privilege Levels

Users are programmed with a “privilege level” (see Table 5.1). Each privilege level gives a User Web access to specific menus, as shown in Table 5.2. A User has access to his/her level menus, plus all menus of the lesser privilege levels.

**Table 5.1 User Privilege Levels**

Access Level (Privilege Level)	Default User Name and Password	Authority
Level A (Browser)	none set	The User can only read (browse) information in the menus.
Level B (Operator)	none set	The User has access to the system "Manual Mode Control Settings" menus.
Level C (Engineer)	none set	The User has access to the system "Settings" menus.
Level D (Administrator)	admin, 640275	The User has full access to all menus; including downloading the "SettingParam.tar" file, updating the OS application, and modify/add/delete Users.

**Table 5.2 Authority Level**

Web Interface Tab	Signal	Manual Mode	Authority Level Required - Web	Authority Level Required - LCD
Settings / System	Under Voltage 1 (V)	--	Engineer	Operator
	Under Voltage 2 (V)	--	Engineer	Operator
	Over Voltage 1 (V)	--	Operator	Operator
	Over Voltage 2 (V)	--	Engineer	Operator
	System Current Alarm (A)	--	Engineer	not available
	High Load Level 1 (%)	--	Engineer	not available
	High Load Level 2 (%)	--	Engineer	not available
	Relay Test (type)	--	Engineer	not available
	Relay Test Time (sec)	--	Engineer	not available
	Main Ambient Temp Sensor (select from list)	--	Engineer	not available
	Fail Safe Mode (enable/disable)	--	Engineer	not available
	Rectifier Expansion (disable or type)	--	Engineer	Operator
	Power Split Mode (enable/disable)	--	Operator	not available
	Power Split Current Limit (%)	--	Engineer	not available
	Delta Voltage (V)	--	Engineer	not available
	Outgoing Alarms Blocked (normal/blocked)	--	Engineer	Operator
	Estop/EShutdown (disable or type)	--	Operator	not available
	Audible Alarm (on/off/time)	--	Engineer	Operator
	Auto/Manual State (auto/manual)	--	Operator	Operator
	Manual Mode Time Limit (hr)	--	Operator	not available
	Maintenance Cycle (enable/disable)	--	Engineer	Operator
	Clear Maintenance Run Time (yes)	Yes	Operator	not available
	LCD Rotation (0deg/90deg/big screen)	--	Engineer	Operator
Solar Mode (disable/solar/rect-solar)	--	Engineer	not available	
HTD Point (deg)	--	Operator	Operator	

Web Interface Tab	Signal	Manual Mode	Authority Level Required - Web	Authority Level Required - LCD
	HTD Reconnect Point (deg)	--	Operator	Operator
	Time Display Format (format)	--	Engineer	not available
	Temperature Format (C or F)	--	Engineer	not available
	System Alarm Function CR,CR/MJ,CR/MJ/MN)	--	Engineer	not available
	AC Generator Function	--	Engineer	not available
	Manual AC Generator Run	--	Engineer	not available
	AC Generator Start Voltage	--	Engineer	not available
	AC GEN Start Batt Capacity	--	Engineer	not available
	DI for AC Generator	--	Engineer	not available
	Site Has AC Utility Power	--	Engineer	not available
Settings / Battery	Equalize/Float Charge (Float/Equalize)	--	Operator	Operator
	Float Charge Voltage (V)	--	Engineer	Operator
	Equalize Voltage (V)	--	Engineer	Operator
	Battery 1 Shunt (yes or no)	--	Engineer	Operator
	Batt# Rated Capacity (AHr)	--	Engineer	Operator
	Reset Battery Capacity (Yes)	--	Operator	Operator
	Number of Battery Fuses (0 to 6)	--	Operator	not available
	Calculate Battery Current (yes or no)	--	Engineer	not available
	Temp Comp Sensor (select from list)	--	Engineer	Operator
	Comp Temp High2 (deg)	--	Engineer	not available
	Comp Temp High1 (deg)	--	Engineer	not available
	Comp Temp Low (deg)	--	Engineer	not available
	Temp Comp Center (deg)	--	Engineer	Operator
	Temp Comp Coefficient (mV/deg)	--	Engineer	Operator
	Temp Comp Voltage Clamp (enable/disable)	--	Engineer	Operator
	Temp Comp Max Voltage (V)	--	Engineer	Operator
	Temp Comp Min Voltage (V)	--	Engineer	Operator
	BTRM Temp Sensor (select from list)	--	Engineer	not available
	BTRM Temp High2 (deg)	--	Engineer	not available
	BTRM Temp High1 (deg)	--	Engineer	not available
	BTRM Action (disable/lower voltage)	--	Engineer	not available
	BTRM Voltage (V)	--	Engineer	not available
	Low Capacity Point (%)	--	Engineer	not available
	Curr Limited Mode (yes or no)	--	Engineer	Operator
	Battery Current Limit (# x C10)	--	Engineer	Operator
	Over Current Limit (# x C10)	--	Engineer	Operator
	Automatic Equalize (yes or no)	--	Engineer	Operator
	Equalize Stop Current (# x C10)	--	Engineer	not available
	Equalize Stop Time Delay (min)	--	Engineer	not available
	Maximum Equalize Charge (min)	--	Engineer	not available
	Cyclic Equalize (yes or no)	--	Engineer	not available
	Cyclic Equalize Start Time (date and time)	--	Engineer	not available

Web Interface Tab	Signal	Manual Mode	Authority Level Required - Web	Authority Level Required - LCD
	EIB-# Voltage Type (disable or type)	--	Operator	not available
	EIB-# Block In-Use Num (0 to 8)	--	Operator	not available
	Charging Efficiency (%)	--	Engineer	not available
	Time to ##C10 Discharge (10 values in hr)	--	Engineer	not available
	Clear Abnormal Bat Current (yes)	--	Operator	Operator
Settings / ECO	ECO Mode (enable/disable)	--	Operator	Operator
	Best Operating Point (%)	--	Engineer	Operator
	Load Fluctuation Range (%)	--	Engineer	Operator
	System Energy Saving Point (%)	--	Engineer	not available
	Cycle Period (hr)	--	Engineer	Operator
	All Rects On Time (min)	--	Engineer	Operator
	Turn Off Delay (min)	--	Engineer	not available
	Clear Cycle Alarm (yes)	--	Engineer	Operator
Settings / LVD	LVD 1 & 2 (enable/disable)	--	Operator	Operator
	LVD 1 & 2 Mode (voltage/time)	--	Operator	Operator
	LVD 1 & 2 Disconnect Voltage (V)	--	Operator	Operator
	LVD 1 & 2 Reconnect Voltage (V)	--	Operator	Operator
	LVD 1 & 2 Reconnect Delay (min)	--	Operator	not available
	LVD 1 & 2 Time (min)	--	Operator	Operator
	LVD 1 & 2 Dependency (none/LVD1/LVD2/LVD3)	--	Operator	not available
	LVD 1 & 2 High Temp Disconnect (enable/disable)	--	Operator	Operator
	LVD Contactor Type (bi/mono/mono w-sample)	--	Operator	not available
	LVD 1 & 2 Control (connected/disconnected)	Yes	Operator	Operator
Settings / Temp Probes	## Temp# (none/ambient/battery)	--	Operator	not available
	## Temp# High2 (deg)	--	Engineer	not available
	## Temp# High1 (deg)	--	Engineer	not available
	## Temp# Low (deg)	--	Engineer	not available
Settings / Rectifiers	Current Limit (enable/disable)	--	Operator	Operator
	Current Limit Point (A)	--	Engineer	Operator
	HVSD (enable/disable)	--	Operator	not available
	HVSD Limit (V)	--	Engineer	not available
	Restart on HVSD (enable/disable)	--	Engineer	not available
	HVSD Restart Time (sec)	--	Engineer	not available
	Walk-in (enable/disable)	--	Engineer	Operator
	Walk-in Time (sec)	--	Engineer	Operator
	Sequence Start Interval (sec)	--	Engineer	Operator
	Nominal AC Voltage (V)	--	Operator	Operator
	Mains Failure Alarm Limit 1 (%)	--	Operator	Operator
	Mains Failure Alarm Limit 2 (%)	--	Operator	Operator
	Turn On When AC Over (yes or no)	--	Engineer	not available
	Input Current Limit (A)	--	Engineer	not available
	Mix HE Power (derated/non-derated)	--	Engineer	not available



Web Interface Tab	Signal	Manual Mode	Authority Level Required - Web	Authority Level Required - LCD
	Diesel Generator Power Limit (enable/disable)	--	Operator	not available
	Rectifier Trim (V)	Yes	Operator	not available
	DC On/Off Control (on all or off all)	Yes	Operator	not available
	AC On/Off Control on all or off all)	Yes	Operator	not available
	Rectifiers LED Control (stop or all flashing)	Yes	Operator	not available
	Fan Speed Control (auto or full)	--	Operator	not available
	Confirm Rectifier ID/Feed (yes)	--	Operator	not available
	Reset Rectifier IDs (yes)	--	Operator	not available
	Clear Cycle Alarm (yes)	--	Operator	not available
	Clear Rectifier Lost Alarm (yes)	--	Operator	Operator
	Clear Rect Comm Fail Alarm (yes)	--	Operator	Operator
Settings / Battery Test	Battery Test Control (stop/start)	--	Operator	Operator
	AC Fail Test (enable/disable)	--	Engineer	not available
	Constant Current Test (enable/disable)	--	Engineer	not available
	Constant Current Test (A)	--	Engineer	not available
	Short Test (enable/disable)	--	Engineer	not available
	Short Test Cycle (days)	--	Engineer	not available
	Short Test Time (min)	--	Engineer	not available
	Short Test Max Difference (# X C10)	--	Engineer	not available
	Test Voltage Level (V)	--	Engineer	Operator
	End Test Voltage (V)	--	Engineer	Operator
	End Test Time (min)	--	Engineer	Operator
	End Test Capacity (%)	--	Engineer	Operator
	Record Threshold (V)	--	Engineer	Operator
	Number of Planned Tests (0 to 12)	--	Engineer	not available
	Clear Bad Battery Alarm (yes)	--	Operator	Operator
	Clear Battery Test Fail Alarm (yes)	--	Operator	Operator
	Clear Discharge Curr Imbalance (yes)	--	Operator	Operator
Settings / Inverters	DC Low Voltage Off	--	Engineer	not available
	DC Low Voltage On	--	Engineer	not available
	DC High Voltage Off	--	Engineer	not available
	DC High Voltage On	--	Engineer	not available
	Primary Input Power	--	Engineer	not available
	Output On/Off Control (on all or off all)	Yes	Operator	not available
	LED Control (stop or all flashing)	Yes	Operator	not available
	Fan Speed Control (auto or full)	--	Operator	not available
	Confirm Inverter ID/Feed (yes)	--	Operator	not available
	Reset Inverter IDs (yes)	--	Operator	not available
	Clear Inverter Lost Alarm (yes)	--	Operator	not available
	Clear Inverter Comm Fail Alarm (yes)	--	Operator	not available
	Clear All Invt Comm Fail Alarm (yes)	--	Operator	not available
	Clear Fault (yes)	--	Operator	not available

Web Interface Tab	Signal	Manual Mode	Authority Level Required - Web	Authority Level Required - LCD
Settings / Time Settings	Specify Time (from PC or set manually)	--	Engineer	Operator
	Local Zone (manual entry)	--	Engineer	not available
	Get Time Automatically from Time Servers	--	Engineer	not available
	Primary Server IP	--	Engineer	not available
	Secondary Server IP	--	Engineer	not available
	Interval to Adjust Time (min)	--	Engineer	not available
Advanced Settings / Ethernet	IPV4 - IP Address	--	Administrator	Operator
	IPV4 - Subnet Mask	--	Administrator	Operator
	IPV4 - Default Gateway	--	Administrator	Operator
	IPV4 - DHCP Server IP	--	Administrator	Operator
	IPV6 - Link Local Address	--	Administrator	Operator
	IPV6 - IPV6 Address	--	Administrator	Operator
	IPV6 - Subnet Prefix	--	Administrator	Operator
	IPV6 - Default Gateway	--	Administrator	Operator
	IPV6 DHCP - Server IP	--	Administrator	Operator
Advanced Settings / Users	User Information (delete command)	--	Administrator	not available
	Add or Modify User - User Name	--	Administrator	not available
	Add or Modify User - Privilege	--	Administrator	not available
	Add or Modify User - Confirm	--	Administrator	not available
Advanced Settings / SNMP	Accepted Trap Level (not used/all/major/critical)	--	Administrator	not available
	NMSV2 Configuration - delete command	--	Administrator	not available
	NMSV2 Configuration - NMS IP	--	Administrator	not available
	NMSV2 Configuration - Public Community	--	Administrator	not available
	NMSV2 Configuration - Private Community	--	Administrator	not available
	NMSV2 Configuration - Trap (enable/disable)	--	Administrator	not available
	NMSV3 Configuration - delete command	--	Administrator	not available
	NMSV3 Configuration - User Name	--	Administrator	not available
	NMSV3 Configuration - Priv Password DVS	--	Administrator	not available
	NMSV3 Configuration - Auth Password MD5	--	Administrator	not available
	NMSV3 Configuration - Trap (enable/disable)	--	Administrator	not available
	NMSV3 Configuration - Trap IP	--	Administrator	not available
NMSV3 Configuration - Trap Security Level	--	Administrator	not available	
Advanced Settings / Language	Local Language (select)	--	Administrator	Operator
Advanced Settings / SW Maintenance	Auto Config	--	Administrator	Operator
	Restore Factory Defaults	--	Administrator	Operator
	Retrieve SettingParam.tar	--	Administrator	not available
	Upload/Download	--	Administrator	Operator
Advanced Settings / Alarms	New Alarm Level	--	Administrator	not available
	New Relay Number	--	Administrator	not available
Advanced Settings / DI Alarms	Signal Full Name	--	Administrator	not available
	Signal Abbreviated Name	--	Administrator	not available

Web Interface Tab	Signal	Manual Mode	Authority Level Required - Web	Authority Level Required - LCD
	New Alarm Level	--	Administrator	not available
	New Relay Number	--	Administrator	not available
	New Alarm State	--	Administrator	not available
Advanced Settings / DO (Relay)	Relay Test (enable/disable)	--	Administrator	not available
	Relay Test Time (sec)	--	Administrator	not available
	Each Relay (energize/de-energize)	--	Administrator	not available
	Signal Full Name	--	Administrator	not available
Advanced Settings / Shunts	Set type (Not Used/General/load/Battery/Source)	--	Administrator	not available
	Signal Full Name	--	Administrator	not available
	Signal Abbreviated Name	--	Administrator	not available
	Full Scale Current (A)	--	Administrator	not available
	Full Scale Voltage (mV)	--	Administrator	not available
	Break Value (A)	--	Administrator	not available
	High 1 Curr Limit Alarm (A)	--	Administrator	not available
	High 1 Curr Alarm Severity (NA/MN/MJ/CR)	--	Administrator	not available
	High 1 Curr Alarm Relay	--	Administrator	not available
	High 2 Curr Limit Alarm (A)	--	Administrator	not available
	High 2 Curr Alarm Severity (NA/MN/MJ/CR)	--	Administrator	not available
	High 2 Curr Alarm Relay	--	Administrator	not available
Advanced Settings / Fuse	Signal Full Name	--	Administrator	not available
	Signal Abbreviated Name	--	Administrator	not available
Advanced Settings / Alarm Report	SMTP – Email To	--	Administrator	not available
	SMTP – Server IP	--	Administrator	not available
	SMTP – Server Port	--	Administrator	not available
	SMTP – Email From	--	Administrator	not available
	SMTP – Privilege (enable/disable)	--	Administrator	not available
	SMTP – SMTP Account	--	Administrator	not available
	SMTP – SMTP Password	--	Administrator	not available
	SMTP – Alarm Report Level (none/all/MJ-CR/CR)	--	Administrator	not available
	SMS – Cell Phone Number 1	--	Administrator	not available
	SMS – Cell Phone Number 2	--	Administrator	not available
	SMS – Cell Phone Number 3	--	Administrator	not available
	SMS – Alarm Report Level (none/all/MJ-CR/CR)	--	Administrator	not available
Advanced Settings / Power Split	Power Split Mode (enable/disable)	--	Administrator	not available
	LVD# Equipment	--	Administrator	not available
	LVD# Signal Type	--	Administrator	not available
	LVD# Signal Name	--	Administrator	not available
	BATTERY_TEST Equipment	--	Administrator	not available
	BATTERY_TEST Signal Type	--	Administrator	not available
	BATTERY_TEST Name	--	Administrator	not available
	EQUALIZE_CHARGE Equipment	--	Administrator	not available
EQUALIZE_CHARGE Signal Type	--	Administrator	not available	

Web Interface Tab	Signal	Manual Mode	Authority Level Required - Web	Authority Level Required - LCD
	EQUALIZE_CHARGE Name	--	Administrator	not available
Advanced Settings / Monitor Protocol	Protocol (EEM/YDN23/Modbus/T1)	--	Administrator	not available
	Modbus – Protocol Type	--	Administrator	not available
	Modbus – Protocol Media	--	Administrator	not available
	Modbus – Self Address	--	Administrator	not available
Advanced Settings / Clear Data	Alarm History	--	Administrator	Browser
	Data History	--	Administrator	not available
	Event Log	--	Administrator	not available
	Battery Test Log	--	Administrator	not available

**Radius Server Settings**

Enter the following radius server settings as applicable.

1. **Enable Radius:** Check this box to enable the radius server authentication feature. The controller will check the radius server for password authentication.
2. **NAS-Identifier:** Check this box to use the Site Name as the NAS-Identifier. If checked, the "Site Name" programmed into the controller is sent as the NAS-identifier in the authorization request.
3. **Primary Server:** The IP address of the primary radius server.
4. **Primary Port:** The port number on the primary radius server used to access the radius interface (default 1812).
5. **Secondary Server:** The IP address of the secondary radius server (optional). The controller will authenticate using the secondary server if the primary server is unreachable.
6. **Secondary Port:** The port number on the secondary radius server used to access the radius interface (default 1812) (optional). The controller will authenticate using the secondary server if the primary server is unreachable.
7. **Secret Key:** A secret key phrase (1 to 31 alphanumeric characters; all ASCII characters valid). This secret key phrase is sent to the radius server with the authorization request so the server knows it is a valid request.
8. **Confirm:** Re-enter the Secret Key to confirm it was typed correctly. The "Secret Key" entry and "Confirm" entry must match.
9. Click the "Save" button to save the radius server settings.

## **SNMP Tab**

Configures SNMP V2 and V3 parameters.

### **Accepted Trap Level Parameter Description**

- **Accepted Trap Level:** Sets SNMP V2 and V3 trap level.

### **Adding an Entry**

1. Enter the parameters in the parameter fields.
2. Click the "Add" button to add the entry.



**NOTE!** To reset the form (i.e. to start over) and erase all information entered, click on the "Reset" button.

### **Modifying an Existing Entry**

1. Select the Entry to be modified from those listed at the top of the screen.
2. Modify the parameters.
3. Click the "Modify" button to modify the parameters for this Entry.



**NOTE!** To reset the form (i.e., to start over) and erase all information entered, click on the "Reset" button.

### **Deleting an Entry**

1. Select the Entry to be deleted from those listed at the top of the screen.
2. Click the "Delete" button to delete this Entry.

**NMSV2 Configuration Description (Network Management System)**

Configures SNMP Version 1 and 2 parameters.

You can configure the following parameters.

- **NMS IP:** The permitted IP to access the NMSV2 agent. Check the IPV6 box when entering an IPV6 address.
- **Public Community:** The public community string.
- **Private Community:** The private community string.
- **Trap Enabled:** Trap function enabled or disabled.



**NOTE!** Only listed IP Addresses will have SNMP access.



**NOTE!** To reset the form (i.e., to start over) and erase all information entered, click on the "Reset" button.

Figure 5.64 SNMP - NMSV2 Configuration (cont'd on next page)

Accepted Trap Level : Not Used Not Used

### NMSV2 Configuration

NMS IP	Public Community	Private Community	Trap Enabled
<input type="radio"/> 0.0.0.0	public	private	Disabled

NMS IP:  Public Community:   
 Private Community:  Trap Enabled:

### NMSV3 Configuration

User Name	Priv Password	Auth Password	Trap Enabled	Trap IP	Trap Security Level

User Name:  Priv Password DES:   
 Auth Password MD5:  Trap Enabled:   
 Trap IP:   IPV6 Trap Security Level:

Figure 5.64 SNMP - NMSV2 Configuration (cont'd from previous page)

Accepted Trap Level : Not Used Not Used Set

### NMSV2 Configuration

NMS IP	Public Community	Private Community	Trap Enabled
<input type="radio"/> 0.0.0.0	public	private	Disabled

Delete

NMS IP:   IPV6 Public Community:   
Private Community:  Trap Enabled: Disabled ▼

Add Reset

### NMSV3 Configuration

User Name	Priv Password	Auth Password	Trap Enabled	Trap IP	Trap Security Level
<input type="text"/>	<input type="text"/>	<input type="text"/>	<input type="checkbox"/>	<input type="text"/>	<span>NoAuthNoPriv</span> <span>▼</span>

Delete

User Name:  Priv Password DES:   
Auth Password MD5:  Trap Enabled: Disabled ▼  
Trap IP:   IPV6 Trap Security Level: NoAuthNoPriv ▼

Add Reset

IPV6 checkbox appears once you start typing an NMS IP. Check the IPV6 box when entering an IPV6 address.



### **NMSV3 Configuration Description (Network Management System)**

Configures SNMP Version 3 parameters.

You can configure the following parameters.

- **Use Name:** The permitted User to access the NMSV3 agent.
- **Priv Password DES:** The privacy DES password used to encrypt the data.
- **Auth Password MD5:** The authorization MD5 password used to encrypt the digital signature.
- **Trap Enabled:** Trap function enabled or disabled.
- **Trap IP:** The IP to which the trap is sent. Check the IPV6 box when entering an IPV6 trap address.
- **Trap Security Level:** The SNMP v3 data security level (NoAuthNoPriv, AuthNoPriv, or AuthPriv).
  - **NoAuthNoPriv:** SNMP messages are sent without authentication and without privacy.
  - **AuthNoPriv:** SNMP messages are sent with authentication but without privacy.
  - **AuthPriv:** SNMP messages are sent with authentication and with privacy.



**NOTE!** For SNMP v3, the security level for Get/Set/Walk operations is set to “AuthPriv” and cannot be adjusted.



**NOTE!** Controller must be reset after configuration of initial SNMP v3 User (Advanced Settings Menu / SW Maintenance Tab / Restore Factory Defaults / Reboot Controller).

**Figure 5.65 SNMP - NMSV3 Configuration**

The screenshot displays the configuration page for NMSV3. At the top, there is a navigation bar with tabs: Ethernet, Users, **SNMP**, Language, SW Maintenance, Alarms, DI Alarms, DO(relay), Shunts, Fuse, Alarm Report, Power Split, and Monitor Prot. Below the navigation bar, the 'Accepted Trap Level' is set to 'Not Used'. The main configuration area is divided into two sections: NMSV2 Configuration and NMSV3 Configuration. The NMSV2 section shows a table with columns for NMS IP, Public Community, Private Community, and Trap Enabled. The NMSV3 section shows a table with columns for User Name, Priv Password, Auth Password, Trap Enabled, Trap IP, and Trap Security Level. A callout box points to the IPV6 checkbox in the Trap IP field of the NMSV3 section.

Check the IPV6 box when entering an IPV6 trap address.

## Language Tab

The local display and Web Interface always has an English language option. Multiple local languages are also supported. One local language option is displayed at a time with the English language option. To select another local language option to display, use the Web Interface Language Tab (see Figure 5.66).

You can select from the following local languages: Spanish and French. Once you select a new local language, the controller is automatically rebooted to make the selected local language valid.

See **Figure 5.67** to change the language the local display and Web Interface uses.

**Figure 5.66 Language Tab**

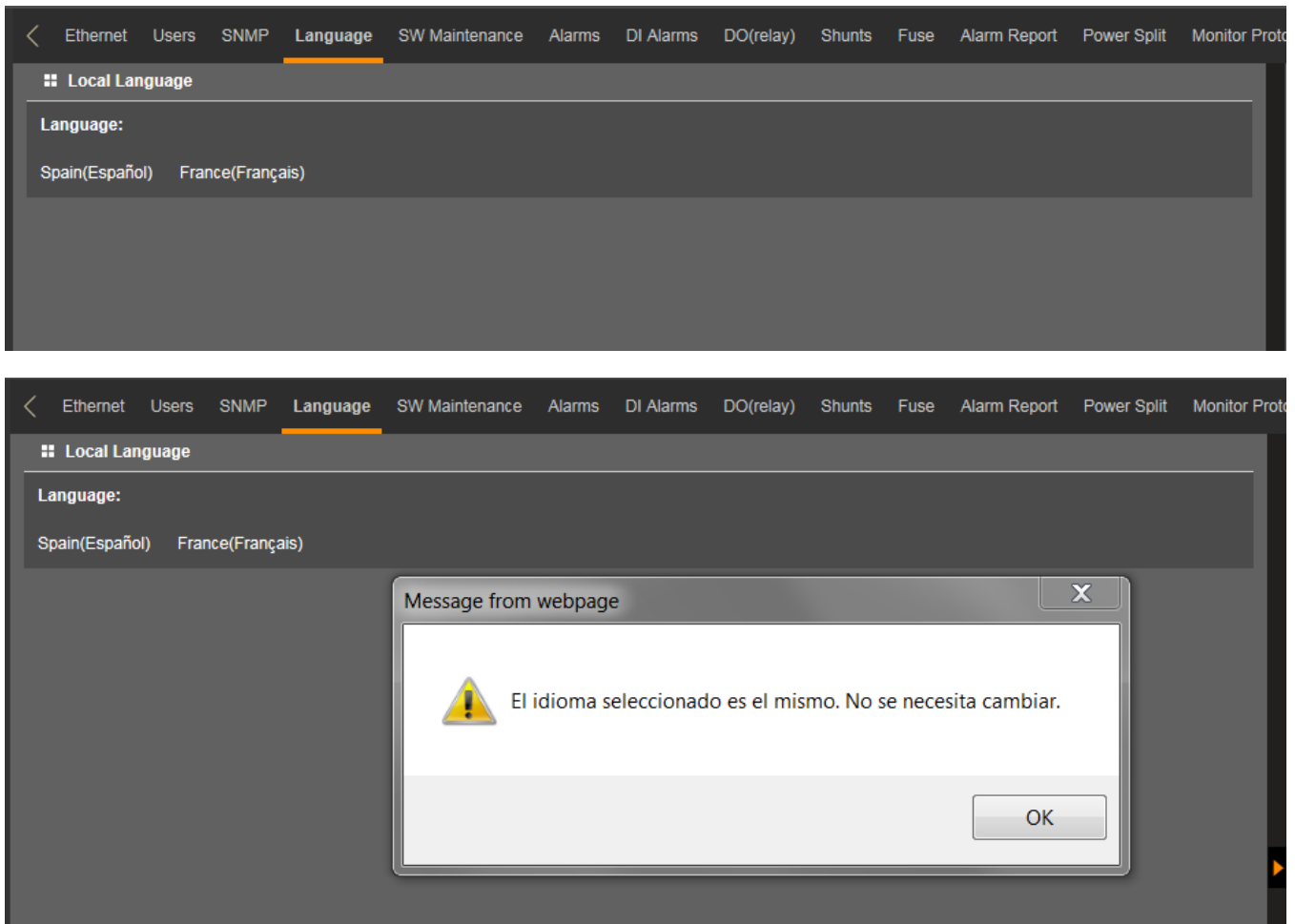
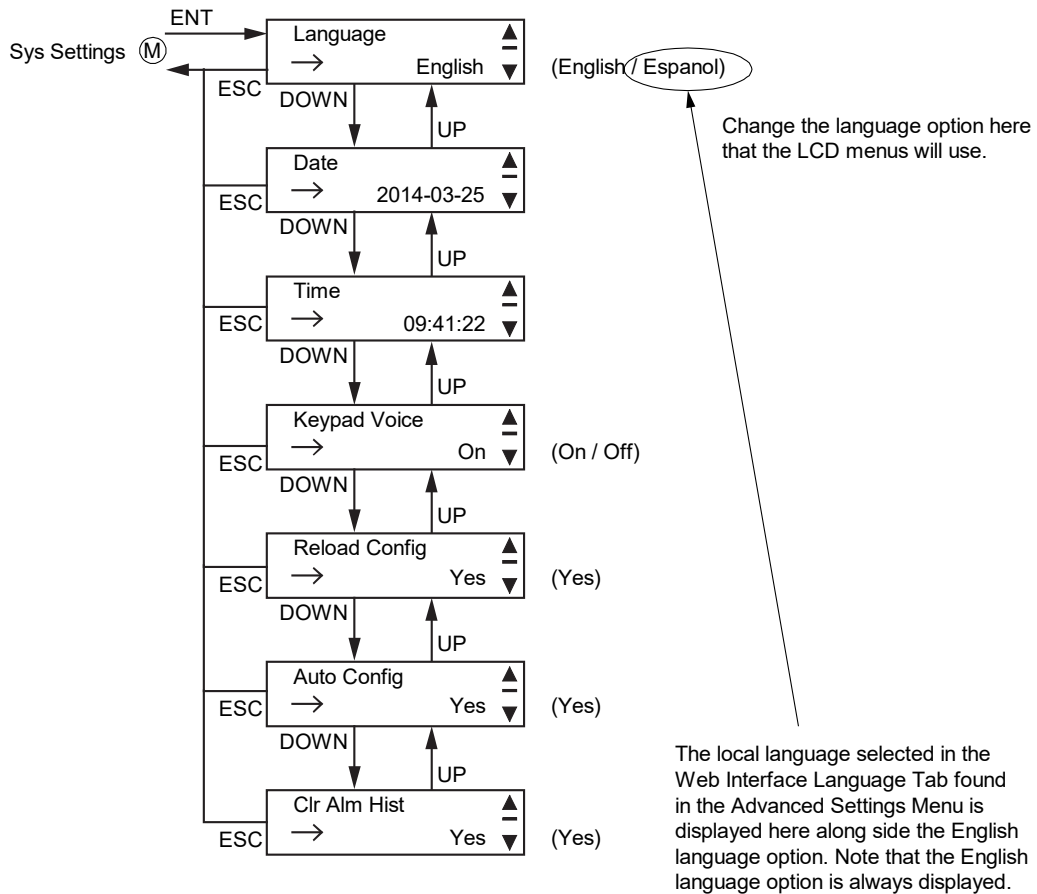
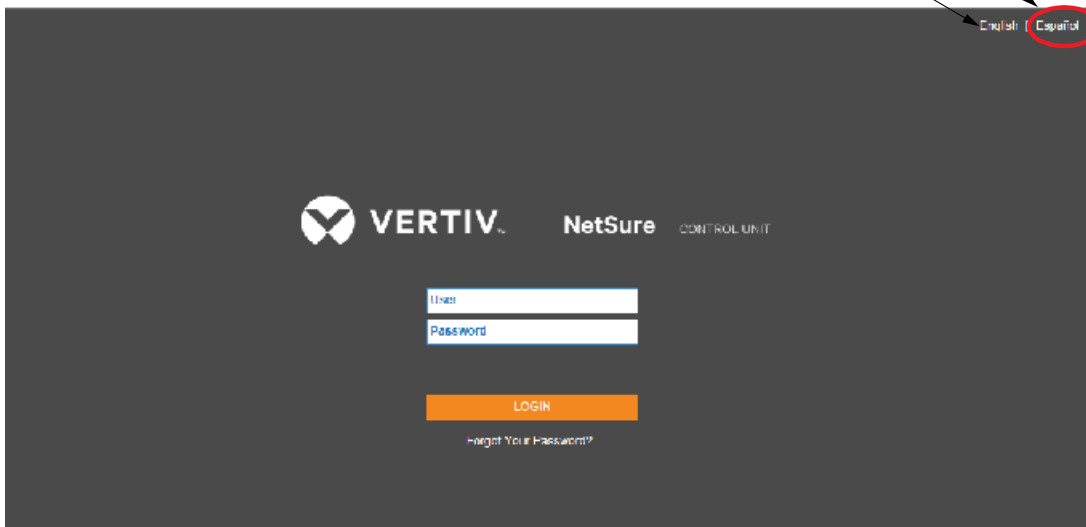


Figure 5.67 Selecting the Local Language for the Local Display and Web Interface Menus

LCD Menu



Click on a language option here that the Web Interface menus will use before entering a User Name and Password.

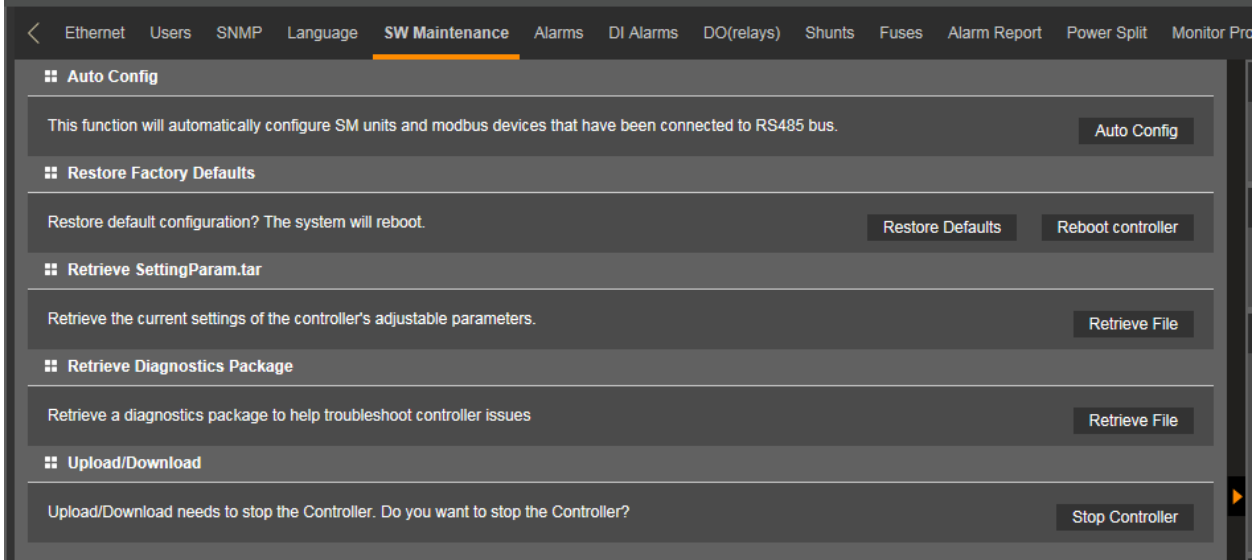


Web Interface Login Screen

## SW Maintenance Tab

Allows you to perform software maintenance procedures.

Figure 5.68 SW Maintenance Tab

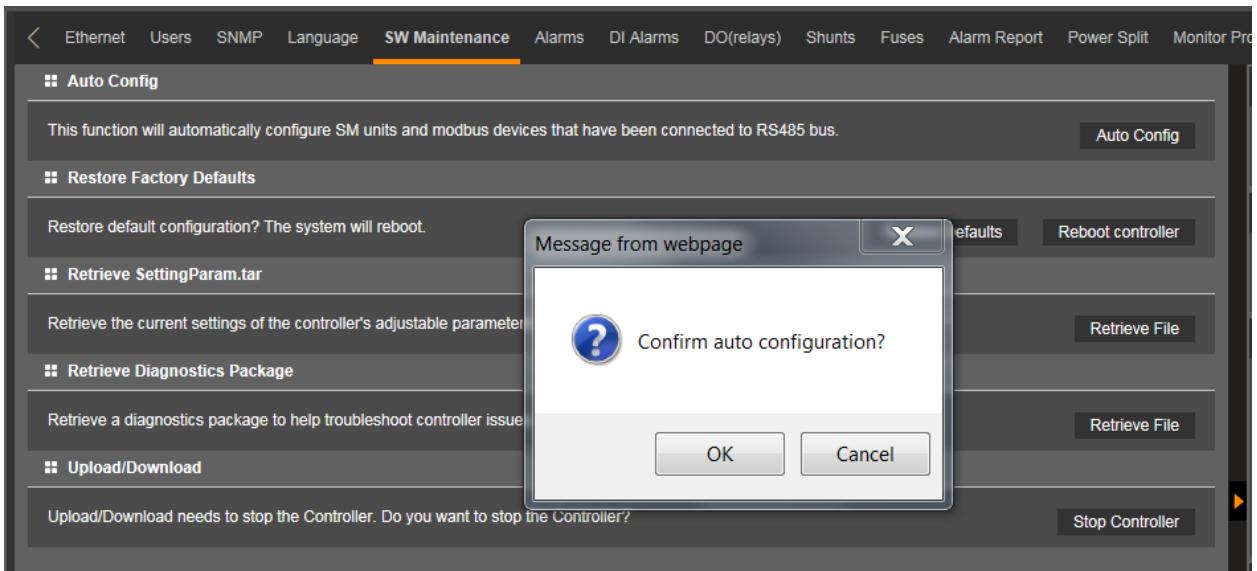


### Auto Config Procedure

The auto configuration feature scans the system for intelligent equipment connected to controller via the RS485 BUS (such as Supervisory Modules and Modbus Devices) and configures these into the controller automatically.

To start the auto configuration process, click on the "Auto Config" button.

Figure 5.69 Auto Config



## Restore Factory Default Configuration Procedure

This procedure is used to restore all changes made to the controller to factory defaults.

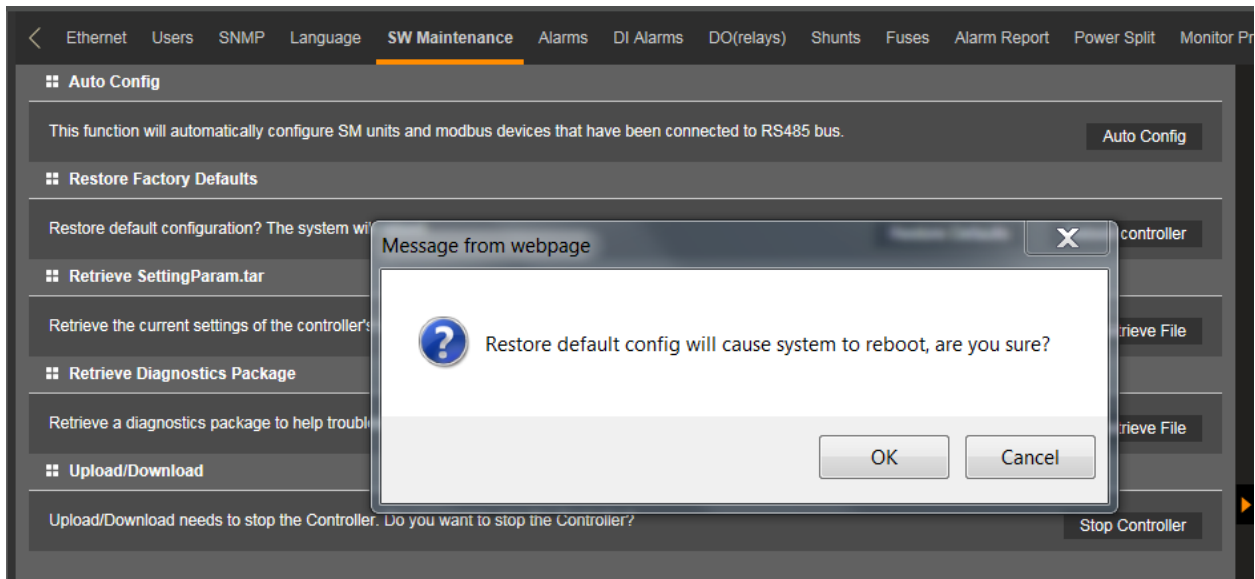
### Procedure



**ALERT!** When this procedure is performed, the controller's existing configuration and parameter settings will be lost. The "SettingParam.tar" file is deleted. Before restoring the factory default configuration, if you have made changes to the controller, save the "SettingParam.tar" file (see "Backing Up the Controller Configuration" on page 42).

1. Click on the "Restore Defaults" button.

Figure 5.70 Restore Factory Defaults



2. Click "OK" to confirm to overwrite the existing "SettingParam.tar" file in memory with the stored "SettingParam.tar" file.

The controller will automatically reboot. All settings WILL BE restored to the defaults of the stored "SettingParam.tar" file.



**NOTE!** After rebooting, you must exit your browser and re-login to see any changes made.



**NOTE!** SOME SYSTEMS REQUIRE CHANGES TO THE CONTROLLER CONFIGURATION DURING FINAL TEST BEFORE BEING SHIPPED. These systems are supplied with a USB memory device that contains a "SettingParam.tar" file as shipped. If provided, the "SettingParam.tar" file has a seven-digit UIN (Unique Identification Number) preceding the "SettingParam.tar" filename. The UIN identifies a "SettingParam.tar" file for use with a specific system. This file can be used to restore your system to the configuration as shipped. Refer to "Reloading a Backed-Up Controller Configuration" on page 43 to reload the supplied "SettingParam.tar" file.

TO RESTORE THESE SYSTEMS TO THE CONTROLLER CONFIGURATION AS SHIPPED, RESTORE DEFAULTS AS DESCRIBED ABOVE; THEN RELOAD THE SUPPLIED "SETTINGPARAM.TAR" FILE.

## Retrieve "SettingParam.tar" File Procedure

See also “Backing Up the Controller Configuration” on page 42.

A file named “SettingParam.tar” is automatically created/appended by the controller whenever a User (or the factory at the time of shipment) makes changes to the controller via the local display or Web Interface. This file can be saved to your computer so you can restore any custom settings you may have made.

**NOTE!** *It is strongly recommended that you save a copy of the “SettingParam.tar” file whenever you customize any parameter settings. Then, if you ever replace the controller or perform a “Restore Defaults” procedure, you can restore your customized settings by downloading the previously saved “SettingParam.tar” file back into the controller.*

Prior to changing settings, ensure the current “SettingParam.tar” files are backed up. After making changes, create new backup files.

### Procedure

1. Click on the “Retrieve File” button to save the file named “SettingParam.tar” to your computer. Select where you want the file to be copied to on your computer.

To aid in file management, you may change the name of the “SettingParam.tar” file to differentiate it from other “SettingParam.tar” files saved. The new name can use alpha and numeric characters preceding the original “SettingParam.tar” name (the end of the new file name **must** always be “SettingParam.tar”; for example, an acceptable filename would be “seville4SettingParam.tar”).

Figure 5.71 Retrieve "SettingParam.tar" File

The screenshot displays the Web Interface for the controller, specifically the 'SW Maintenance' tab. The interface includes a navigation menu on the left with options like Home, Settings, History Log, System Inventory, and Advanced Settings. The main content area shows several maintenance options: Auto Config, Restore Factory Defaults, Retrieve SettingParam.tar (which is highlighted), Retrieve Diagnostics Package, and Upload/Download. A 'Retrieve File' button is visible next to the 'Retrieve SettingParam.tar' option. On the right side, there is a 'System Status' and 'System Specifications' panel. At the bottom, a file download dialog is open, asking 'Do you want to open or save SettingParam.tar (46.0 KB) from 10.201.229.44?' with 'Open', 'Save', and 'Cancel' buttons.

## Retrieve Diagnostics Package Procedure

A diagnostics package can be retrieved that contains files useful for Vertiv to diagnose problems with your controller. When asked, retrieve the diagnostics package and send the file to Vertiv.

### Procedure

1. Click on the “Retrieve File” button to save the file named “yyyymmdd\_AllLogs.tar” to your computer. Select where you want the file to be copied to on your computer. Note that the beginning name of the file is the date the file was extracted.

Figure 5.72 Retrieve Diagnostics Package

The screenshot displays the web interface for the controller's maintenance functions. The 'SW Maintenance' tab is active, showing several options: Auto Config, Restore Factory Defaults, Retrieve SettingParam.tar, Retrieve Diagnostics Package, and Upload/Download. The 'Retrieve Diagnostics Package' option is selected, and a 'Retrieve File' button is visible. A file download dialog is open at the bottom of the screen, asking to save the file '20200511\_AllLogs.tar (141 KB) from 10.201.229.44'. The dialog has 'Open', 'Save', and 'Cancel' buttons.

System Status	
System Voltage	53.8V
System Current	0.0A

System Specifications	
System Name	NCU
Rectifiers	4

Controller Specifications	
Product Model	M830D
Serial Number	03190307690
Hardware Version	A16
Software Version	1.2.20P08
Config Version	GEN_Default

Site Information	
Site Name	NCU
Site Location	Vertiv

### Upload/Download Procedure

See also “Backing Up the Controller Configuration” on page 42, “Reloading a Backed-Up Controller Configuration” on page 43, and “Upgrading the Controller Using an Application (“All”) Package” on page 43.

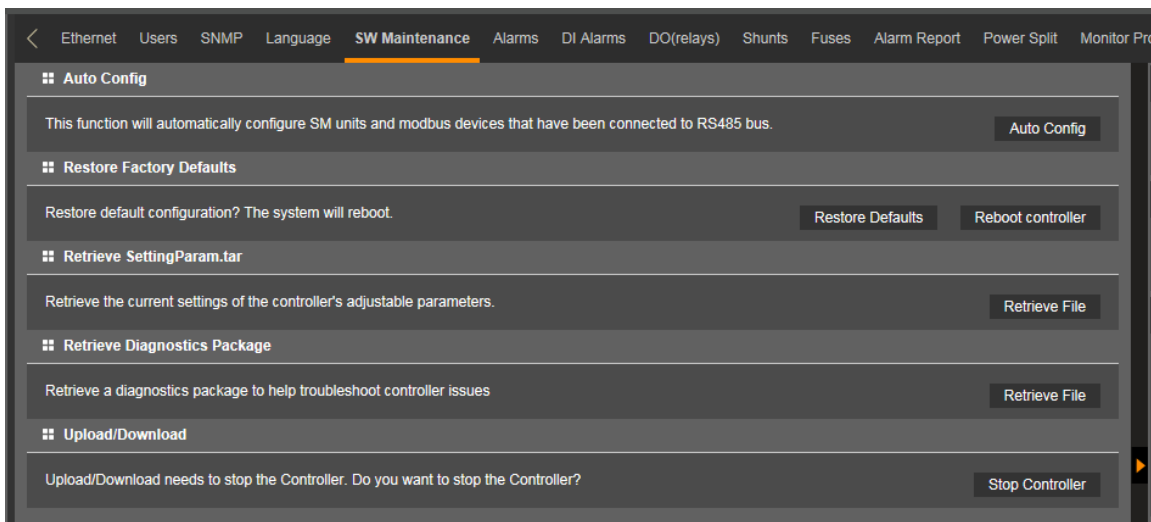
You can download (from your computer into the controller) a configuration package, application (“All”) package, language package (filename of each has a tar or tar.gz extension), or “SettingParam.tar file”.

You can upload (from the controller to your computer) a configuration package or language package.

### Procedure

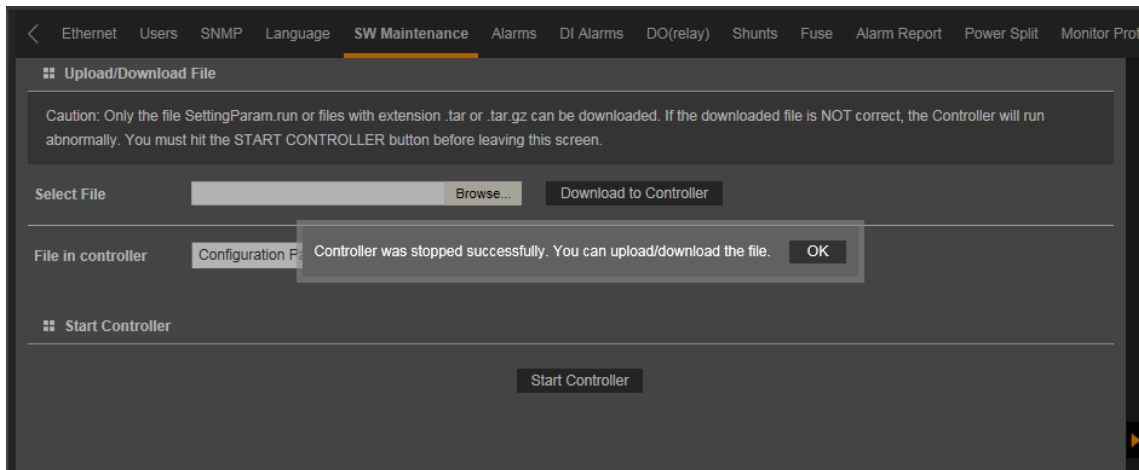
1. To upload or download a file, you need to shut down the controller first. When you select the SW Maintenance Tab, click on the “Stop Controller” button.

Figure 5.73 Upload/Download - Stop Controller



2. The following window opens.

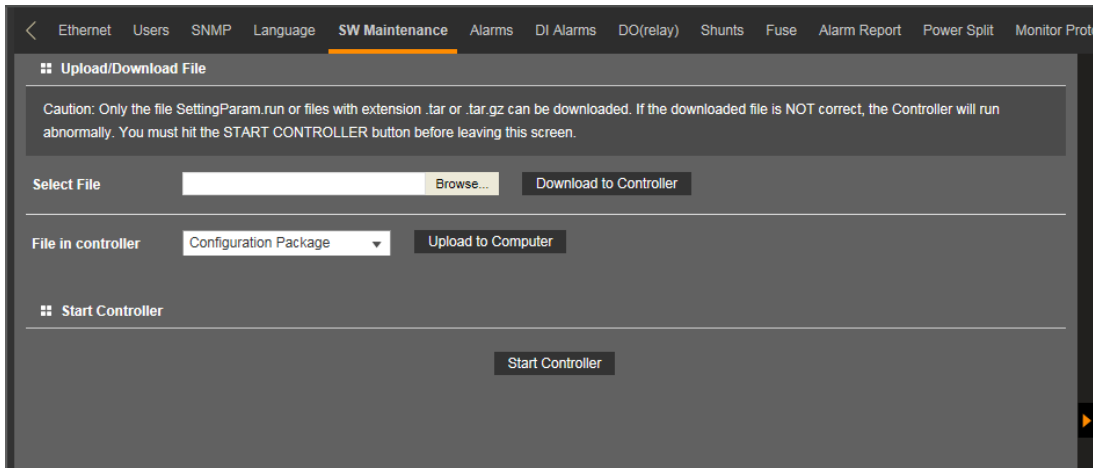
Figure 5.74 Upload/Download --Controller Stopped



3. Click "OK".
4. The following window opens.



Figure 5.75 Upload/Download File



**ALERT!** Never navigate from this Web page without first clicking on "Start Controller". If you do, you will not have Web access. A manual system reset is required to restore Web access.

- To **download** (from your computer into the controller) a configuration package, application ("All") package, language package, or a "SettingParam.tar" file; click the "Browse..." button and navigate to the folder where the file to download is located. Select the file to be downloaded and then click the "Download to Controller" button. Click "Start Controller" to restart the controller with the downloaded file installed.

To **upload** a file to your computer, select "Configuration Package" or "Language Package" from the "File in Controller" drop-down list box, and click on the "Upload to Computer" button to save the file to your computer. Select where you want the file to be copied to on your computer. Click "Start Controller" to restart the Controller.



**NOTE!** A Configuration Package is a package of files containing all the default parameter settings and any User changes to alarm severity levels, relay assignments, signal names and site information. Note that the Configuration Package is part of the "SettingParam.tar" file and does not typically need to be downloaded separately.



**NOTE!** An Application "All" package file has both the application (software) and configuration package and is usually supplied for an application upgrade.



**NOTE!** A Language Package is a package of files containing all the default names of the parameters in two languages. Typically these would be in English and Spanish. The language package cannot be changed by the User. Consult Vertiv if a different language package is required.



**NOTE!** A file named "SettingParam.tar" is automatically created/appended by the Controller whenever a User (or the factory at the time of shipment) makes changes to the controller via the local display or Web Interface. This file also contains the Configuration Package described above.

## Alarms Tab



**NOTE!** This list is dynamic and will only show you the equipment that you have in your system.

- Allows you to define the alarm level for each alarm. (See also Table 1.1 on page 3.)
- Allows you to map alarms to the alarm relays.

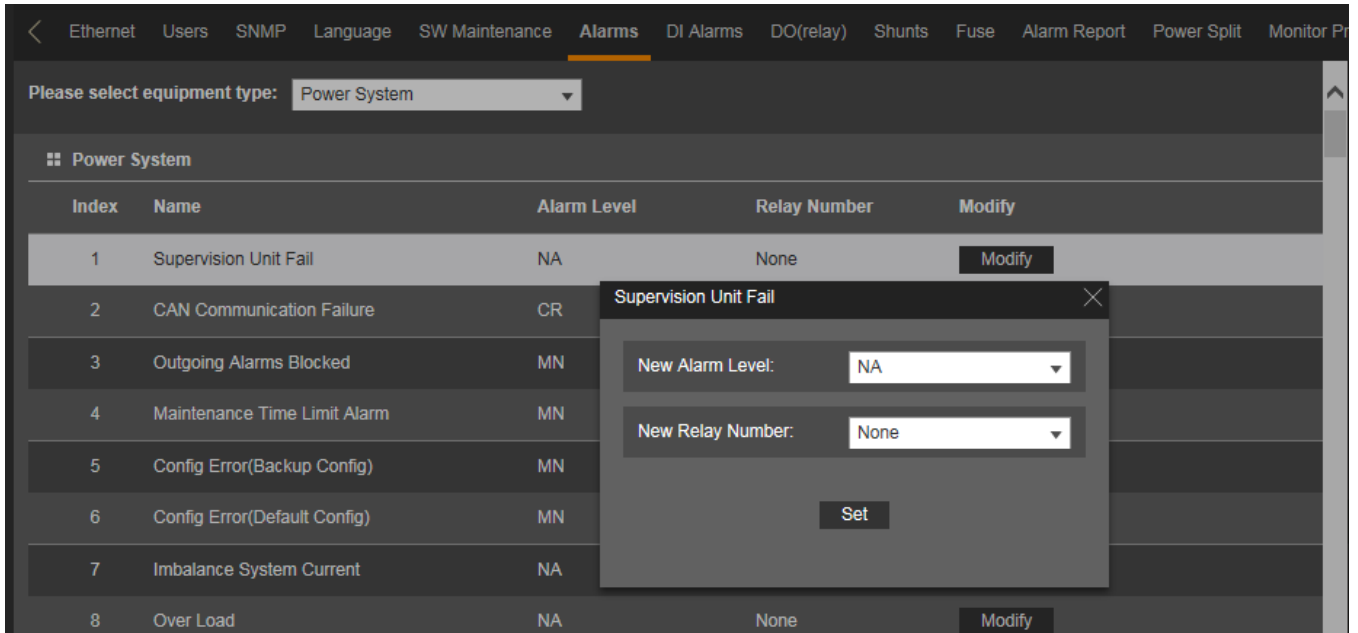
Figure 5.76 Alarms Tab

Index	Name	Alarm Level	Relay Number	Modify
1	Supervision Unit Fail	NA	None	Modify
2	CAN Communication Failure	CR	None	Modify
3	Outgoing Alarms Blocked	MN	None	Modify
4	Maintenance Time Limit Alarm	MN	None	Modify
5	Config Error(Backup Config)	MN	None	Modify
6	Config Error(Default Config)	MN	None	Modify
7	Imbalance System Current	NA	None	Modify
8	Over Load	NA	None	Modify
9	SPD	NA	None	Modify
10	EStop/EShutdown	CR	None	Modify
11	System Temp 1 Not Used	MN	None	Modify
12	System Temp 2 Not Used	MN	None	Modify
13	System Temp 3 Not Used	MN	None	Modify
14	IB2-1 Temp 1 Not Used	MN	None	Modify
15	IB2-1 Temp 2 Not Used	MN	None	Modify

### Procedure

1. Select the equipment type to display the alarms associated to it. Also displayed is the alarm level and alarm relay number assigned to this alarm.
2. To modify the alarm level and/or alarm relay number, click on the “Modify” button for that alarm signal.

- The following window opens. Select the New Alarm Level and/or New Relay Number and click on “Set”.  
“None” means there is no related relay number.

**Figure 5.77 Setting Alarm Level / Relay Number**

The screenshot shows the 'Alarms' configuration page for a 'Power System'. A table lists various alarms with their current levels and relay numbers. A modal window is open for the 'Supervision Unit Fail' alarm, allowing the user to change its level and relay number.

Index	Name	Alarm Level	Relay Number	Modify
1	Supervision Unit Fail	NA	None	Modify
2	CAN Communication Failure	CR		
3	Outgoing Alarms Blocked	MN		
4	Maintenance Time Limit Alarm	MN		
5	Config Error(Backup Config)	MN		
6	Config Error(Default Config)	MN		
7	Imbalance System Current	NA		
8	Over Load	NA	None	Modify

Supervision Unit Fail	
New Alarm Level:	NA
New Relay Number:	None
Set	

### DI Alarms Tab

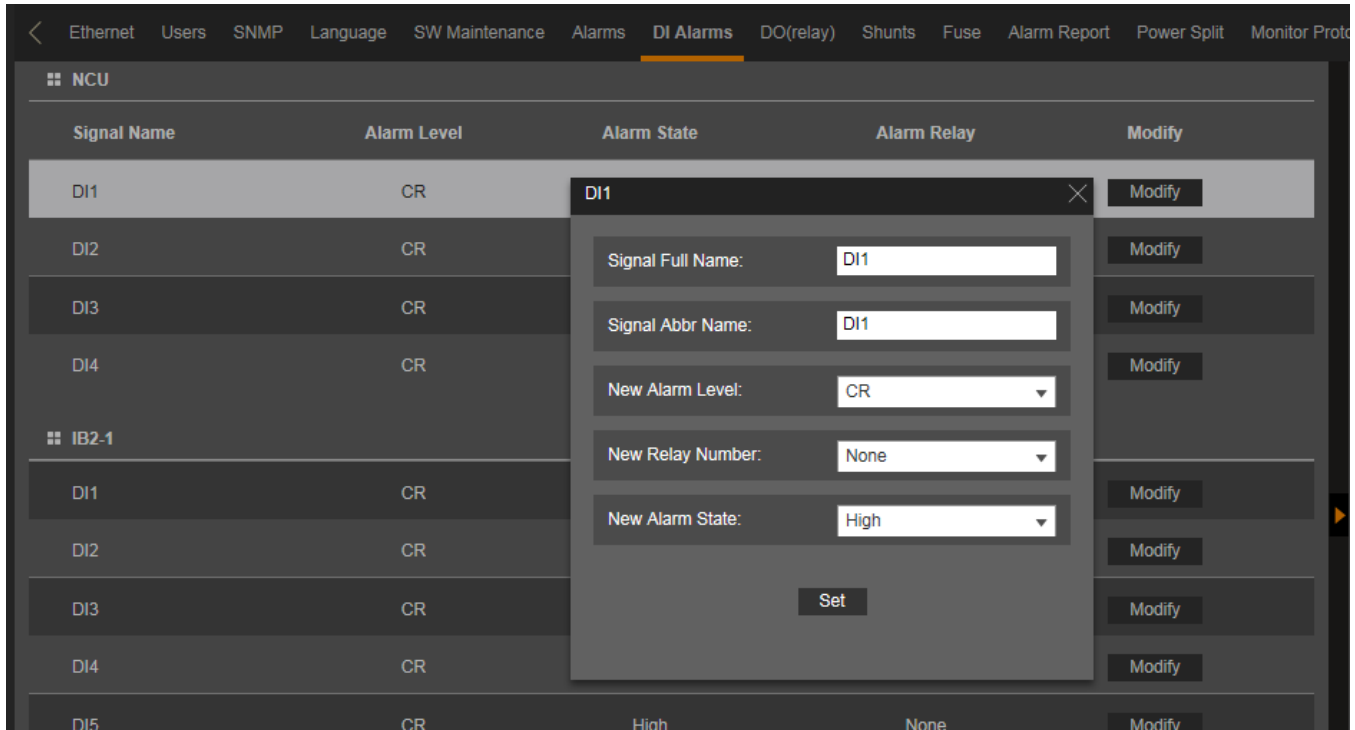
- Allows you to change the digital input alarm signal full name (name displayed in the Web Interface menus).
- Allows you to change the digital input alarm signal abbreviation name (name displayed in the local display menus).
- Allows you to define the alarm level for each digital input alarm. (See also Table 1.1 on page 3.)
- Allows you to map the digital input alarms to the alarm relays.
- Allows you to set the alarm state for the digital inputs (high or low).

Figure 5.78 DI Alarm Tab

Signal Name	Alarm Level	Alarm State	Alarm Relay	Modify
<b>NCU</b>				
D1	CR	High	None	Modify
D2	CR	High	None	Modify
D3	CR	High	None	Modify
D4	CR	High	None	Modify
<b>IB2-1</b>				
D1	CR	High	None	Modify
D2	CR	High	None	Modify
D3	CR	High	None	Modify
D4	CR	High	None	Modify
D5	CR	High	None	Modify
D6	CR	High	None	Modify
D7	CR	High	None	Modify
D8 ESTOP	CR	High	None	Modify

**Procedure**

1. To modify the digital input alarm parameters, click on the “Modify” button for that digital input alarm signal.
2. The following window opens.

**Figure 5.79 Setting DI Alarm**

3. Change the following parameters as desired and click on “Set”.
  - **Signal Full Name:** Name displayed in the Web Interface menus.
  - **Signal Abbr Name:** Name displayed in the local display menus.
  - **New Alarm Level:** Alarm level for this digital input alarm. (See also Table 1.1 on page 3.)
  - **New Relay Number:** Select a relay number to map to this digital input alarm. “None” means there is no related relay number.
  - **New Alarm State:** Select high or low to set the alarm state for the digital input.

## DO (relay) Tab

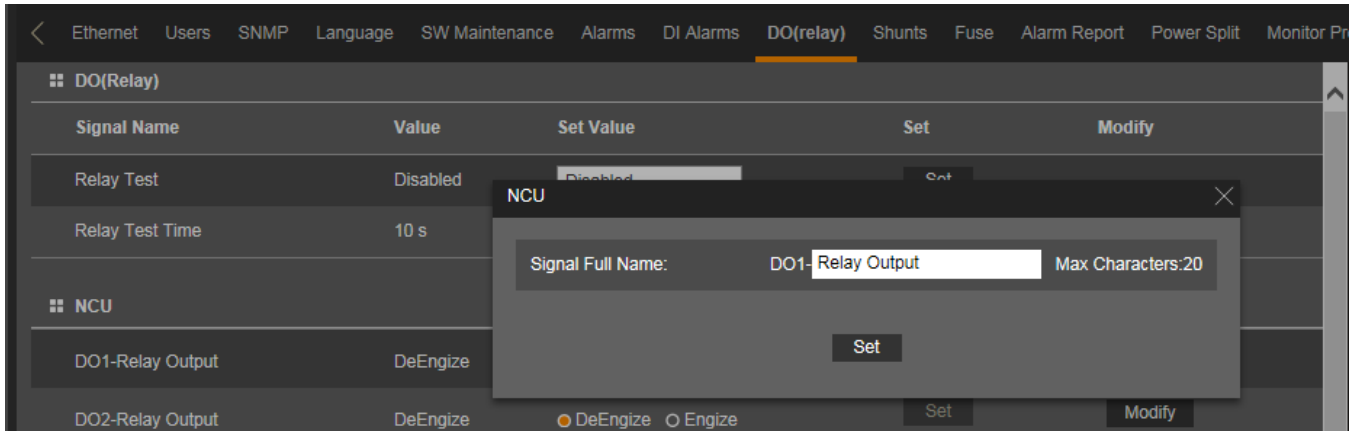
- Allows you to use the relay test feature.
  - **Relay Test:** Sets the Relay Test feature to Automatic, Individual, or Disabled. Refer to “Using the Relay Test Feature” on page 40.
  - **Relay Test Time:** Sets the Relay Test Time for the Automatic Relay Test feature.
- Allows you to set the relay active or not active.
  - Temporarily sets the relay energized or de-energized when the controller is in Manual mode. Setting reverts to original when controller is returned to the Auto mode. Refer to “Manually Forcing Relays” on page 29.
- Allows you to change the relay signal full name (name displayed in the Web Interface menus).

Figure 5.80 DO (Relay) Tab

Signal Name	Value	Set Value	Set	Modify
<b>DO(Relay)</b>				
Relay Test	Disabled	Disabled	Set	
Relay Test Time	10 s	5-120	Set	
<b>NCU</b>				
DO1-Relay Output	DeEngize	<input checked="" type="radio"/> DeEngize <input type="radio"/> Engize	Set	Modify
DO2-Relay Output	DeEngize	<input checked="" type="radio"/> DeEngize <input type="radio"/> Engize	Set	Modify
DO3-Relay Output	DeEngize	<input checked="" type="radio"/> DeEngize <input type="radio"/> Engize	Set	Modify
DO4-Relay Output	DeEngize	<input checked="" type="radio"/> DeEngize <input type="radio"/> Engize	Set	Modify
<b>IB2-1</b>				
DO1-Critical Summary	DeEngize	<input checked="" type="radio"/> DeEngize <input type="radio"/> Engize	Set	Modify
DO2-Major Summary	DeEngize	<input checked="" type="radio"/> DeEngize <input type="radio"/> Engize	Set	Modify
DO3-Over Voltage 1	DeEngize	<input checked="" type="radio"/> DeEngize <input type="radio"/> Engize	Set	Modify
DO4-Under Voltage 1	DeEngize	<input checked="" type="radio"/> DeEngize <input type="radio"/> Engize	Set	Modify
DO5-Under Voltage 2	DeEngize	<input checked="" type="radio"/> DeEngize <input type="radio"/> Engize	Set	Modify
DO6-Mains Failure	DeEngize	<input checked="" type="radio"/> DeEngize <input type="radio"/> Engize	Set	Modify

**Procedure**

1. To change the relay signal full name (name displayed in the Web Interface menus), click on the “Modify” button for that relay.
2. The following window opens.

**Figure 5.81 Changing Relay Signal Full Name**

## Shunts Tab

- Allows you to change the shunts signal full name (name displayed in the Web Interface menus).
- Allows you to change the shunts signal abbreviation name (name displayed in the local display menus).
- Allows you to set the shunts parameters.

Figure 5.82 Shunts Tab

Reference	Shunt Name	Modify/View
<b>Battery 1</b>		
Battery Shunt	Battery Current	Modify/View
<b>DC</b>		
Load Shunt	Load Current	Modify/View
<b>SMDUP 1</b>		
Shunt 1		Modify/View
Shunt 2		Modify/View
Shunt 3		Modify/View
Shunt 4		Modify/View
Shunt 5		Modify/View
Shunt 6		Modify/View
Shunt 7		Modify/View
Shunt 8		Modify/View



**Procedure**

1. To modify the shunt parameters, click on the “Modify/View” button for that shunt.
2. The following window opens.

**Figure 5.83 Setting Shunt Parameters**

	Current Setting		New Setting	Range
Set As	Not Used		Not Used	
Signal Full Name	Load 1		Load 1	Max Characters:20
Signal Abbr Name	Load 1		Load 1	Max Characters:8
Full Scale Current	500	A	500	50 to 12000
Full Scale Voltage	75	mV	75	1 to 150
Break Value	500	A	500	10 to 5000
High 1 Curr Limit Alarm	90	%	90	1 to 100
High 1 Curr Alarm Severity	MJ		MJ	
High 1 Curr Alarm Relay	None		None	
High 2 Curr Limit Alarm	90	%	90	1 to 100
High 2 Curr Alarm Severity	MJ		MJ	
High 2 Curr Alarm Relay	None		None	

**set**

3. Change the following parameters as desired and click on “Set”.

For Battery Shunts:

- Note that for battery shunts, the Set As option is not displayed.

For DC Shunts:

- **Set As (Yes, No):**
  - **Yes:** Indicates this shunt input is used.
  - **No:** Indicates this shunt input is not used.

For EIB and SMDU Shunts:

- **Set As (Not Used, General, Load, Battery, Source):**
  - **Not Used:** Indicates this shunt input is not used.
  - **General:** Indicates the measurement of the shunt will be displayed and will not be added to Total DC Load or Total Battery Load.
  - **Load:** Indicates the measurement of the shunt will be displayed and added to the Total DC Load.
  - **Battery:** Indicates the measurement of the shunt will be displayed and added to the Total Battery Load and used with Battery Management.
  - **Source:** Indicates the measurement of the shunt will be displayed as source current and will be added to other sources. See also “When an EIB and/or SMDU Shunt is Set as Source” on page 105.

For SMDU+ Shunts:

- **Set As (Enabled, Disabled):**
  - **Enabled:** Indicates this shunt input is used.
  - **Disabled:** Indicates this shunt input is not used.
- **Signal Full Name:** Name displayed in the Web Interface menus.
- **Signal Abbr Name:** Name displayed in the local display menus.
- **Full Scale Current:** Enter the value of the shunt's full current rating.
- **Full Scale Voltage:** Enter the value of the shunt's full scale voltage (at rated current).
- **Break Value:** Enter the value desired as the reference for the high current alarms (typically the rating of the breakers or fuses fed by the shunt, if applicable).
- **High 1 Curr Limit Alarm:** Enter the percentage value of the "Break Value" for alarm.
- **High 1 Curr Alarm Severity:** Alarm level for this alarm. (See also Table 1.1 on page 3.)
- **High 1 Curr Alarm Relay:** Select a relay number to map to this alarm.  
“None” means there is no related relay number.
- **High 2 Curr Limit Alarm:** Enter the percentage value of the "Break Value" for alarm.
- **High 2 Curr Alarm Severity:** Alarm level for this alarm. (See also Table 1.1 on page 3.)
- **High 2 Curr Alarm Relay:** Select a relay number to map to this alarm.  
“None” means there is no related relay number.

## Analogs Tab

- Allows you to change the signal full name (name displayed in the Web Interface menus) of any enabled voltage input and analog input set for transducers of any installed SMDUE module.
- Allows you to change the abbreviation name (name displayed in the local display menus) of any enabled voltage input and analog input set for transducers of any installed SMDUE module.
- Allows you to set parameters for any enabled voltage input and analog input set for transducers of any installed SMDUE module.

Figure 5.84 Analogs Tab

Reference	Signal Full Name	Modify
Voltage1	Voltage1	Modify
Voltage Transducer1	Voltage Transducer1	Modify
Input Block 2		
Reference	Signal Full Name	Modify
Voltage2	Voltage2	Modify
Voltage Transducer2	Voltage Transducer2	Modify
Input Block 3		
Reference	Signal Full Name	Modify
Voltage3	Voltage3	Modify
Input Block 4		
Reference	Signal Full Name	Modify
Voltage4	Voltage4	Modify
Input Block 5		
Reference	Signal Full Name	Modify
Voltage5	Voltage5	Modify

**Voltage Input Procedure**

1. To modify the parameters of an enabled voltage input, click on the “Modify” button for that voltage input.
2. The following window opens.

**Figure 5.85 Voltage Input Parameters**

The screenshot shows a configuration window titled "SMDUE 1 > Voltage1". It contains a table of parameters for a voltage input. The table has four columns: "Signal", "Current Setting", "New Current", and "Range".

Signal	Current Setting		New Current	Range
Signal Full Name	Voltage1		<input type="text" value="Voltage1"/>	Max Characters:25
Signal Abbr Name	Voltage1		<input type="text" value="Voltage1"/>	Max Characters:11
Low 1 Alarm Limit	10	V	<input type="text" value="10"/>	0 to 60
Low 1 Alarm Severity	MJ		<input type="text" value="MJ"/>	
Low 1 Alarm Relay	None		<input type="text" value="None"/>	
Low 2 Alarm Limit	0	V	<input type="text" value="0"/>	0 to 60
Low 2 Alarm Severity	MJ		<input type="text" value="MJ"/>	
Low 2 Alarm Relay	None		<input type="text" value="None"/>	
High 1 Alarm Limit	60	V	<input type="text" value="60"/>	0 to 60
High 1 Alarm Severity	MJ		<input type="text" value="MJ"/>	
High 1 Alarm Relay	None		<input type="text" value="None"/>	
High 2 Alarm Limit	60	V	<input type="text" value="60"/>	0 to 60
High 2 Alarm Severity	MJ		<input type="text" value="MJ"/>	
High 2 Alarm Relay	None		<input type="text" value="None"/>	
High 2 Alarm Severity	MJ		<input type="text" value="MJ"/>	
High 2 Alarm Relay	None		<input type="text" value="None"/>	

At the bottom of the window, there is a "Set" button.

3. Change the following parameters as desired and click on “Set”.
  - **Signal Full Name:** Name displayed in the Web Interface menus.
  - **Signal Abbr Name:** Name displayed in the local display menus.
  - **Low 1 Alarm Limit:** Sets the Low 1 alarm point.
  - **Low 1 Alarm Severity:** Alarm level for this alarm. (See also Table 1.1 on page 3.)
  - **Low 1 Alarm Relay:** Select a relay number to map to this alarm.  
“None” means there is no related relay number.
  - **Low 2 Alarm Limit:** Sets the Low 2 alarm point.
  - **Low 2 Alarm Severity:** Alarm level for this alarm. (See also Table 1.1 on page 3.)
  - **Low 2 Alarm Relay:** Select a relay number to map to this alarm.  
“None” means there is no related relay number.
  - **High 1 Alarm Limit:** Sets the High 1 alarm point.
  - **High 1 Alarm Severity:** Alarm level for this alarm. (See also Table 1.1 on page 3.)
  - **High 1 Alarm Relay:** Select a relay number to map to this alarm.  
“None” means there is no related relay number.
  - **High 2 Alarm Limit:** Sets the High 2 alarm point.
  - **High 2 Alarm Severity:** Alarm level for this alarm. (See also Table 1.1 on page 3.)
  - **High 2 Alarm Relay:** Select a relay number to map to this alarm.  
“None” means there is no related relay number.

**Analog Input Set for Voltage Transducer Procedure**

1. To modify the parameters of an analog input set for voltage transducer, click on the “Modify” button for that analog input.
2. The following window opens.

**Figure 5.86 Voltage Transducer Input Parameters**

Signal	Current Setting	New Current	Range
Signal Full Name	Voltage Transducer1	<input type="text" value="Voltage Transducer1"/>	Max Characters:25
Signal Abbr Name	V Tran 1	<input type="text" value="V Tran 1"/>	Max Characters:11
Signal Units	None	<input type="text" value="None"/>	
X1	0	<input type="text" value="0"/>	0 to 10
Y1(value at X1)	0	<input type="text" value="0"/>	-25000 to 25000
X2	0	<input type="text" value="0"/>	0 to 10
Y2(value at X2)	1000	<input type="text" value="1000"/>	-25000 to 25000
Low 1 Alarm Limit	0	<input type="text" value="0"/>	Y1 to Y2
Low 1 Alarm Severity	MJ	<input type="text" value="MJ"/>	
Low 1 Alarm Relay	None	<input type="text" value="None"/>	
Low 2 Alarm Limit	0	<input type="text" value="0"/>	Y1 to Y2
Low 2 Alarm Severity	MJ	<input type="text" value="MJ"/>	
Low 2 Alarm Relay	None	<input type="text" value="None"/>	
Low 2 Alarm Limit	0	<input type="text" value="0"/>	Y1 to Y2
Low 2 Alarm Severity	MJ	<input type="text" value="MJ"/>	
Low 2 Alarm Relay	None	<input type="text" value="None"/>	
High 1 Alarm Limit	0	<input type="text" value="0"/>	Y1 to Y2
High 1 Alarm Severity	MJ	<input type="text" value="MJ"/>	
High 1 Alarm Relay	None	<input type="text" value="None"/>	
High 2 Alarm Limit	0	<input type="text" value="0"/>	Y1 to Y2
High 2 Alarm Severity	MJ	<input type="text" value="MJ"/>	
High 2 Alarm Relay	None	<input type="text" value="None"/>	

3. Change the following parameters as desired and click on “Set”.

- **Signal Full Name:** Name displayed in the Web Interface menus.
- **Signal Abbr Name:** Name displayed in the local display menus.
- **Signal Units:** The units being measured.
- **X1:** The lowest transducer value to be measured. Example 0 mV, 0 mA.
- **Y1(value at X1):** Lowest “Signal Units” value to be displayed when transducer measurement is at the lowest value (X1). Example when the transducer measured value is 0 mv the displayed units is 0 gallons.
- **X2:** The highest transducer value to be measured. Example 25 mV, 25 mA.
- **Y2(value at X2):** Highest “Signal Units” value to be displayed when transducer measurement is at the highest value (X2). Example when the transducer measured value is 25 mv the displayed units is 1000 gallons.
- **Low 1 Alarm Limit:** Sets the Low 1 alarm point.
- **Low 1 Alarm Severity:** Alarm level for this alarm. (See also Table 1.1 on page 3.)
- **Low 1 Alarm Relay:** Select a relay number to map to this alarm. “None” means there is no related relay number.
- **Low 2 Alarm Limit:** Sets the Low 2 alarm point.
- **Low 2 Alarm Severity:** Alarm level for this alarm. (See also Table 1.1 on page 3.)
- **Low 2 Alarm Relay:** Select a relay number to map to this alarm. “None” means there is no related relay number.
- **High 1 Alarm Limit:** Sets the High 1 alarm point.
- **High 1 Alarm Severity:** Alarm level for this alarm. (See also Table 1.1 on page 3.)
- **High 1 Alarm Relay:** Select a relay number to map to this alarm. “None” means there is no related relay number.
- **High 2 Alarm Limit:** Sets the High 2 alarm point.
- **High 2 Alarm Severity:** Alarm level for this alarm. (See also Table 1.1 on page 3.)
- **High 2 Alarm Relay:** Select a relay number to map to this alarm. “None” means there is no related relay number.

**Analog Input Set for Current Transducer Procedure**

1. To modify the parameters of an analog input set for current transducer, click on the “Modify” button for that analog input.
2. The following window opens.

**Figure 5.87 Current Transducer Input Parameters**

Signal	Current Setting	New Current	Range
Signal Full Name	Current Transducer10	<input type="text" value="Current Transducer10"/>	Max Characters:25
Signal Abbr Name	C Tran 10	<input type="text" value="C Tran 10"/>	Max Characters:11
Signal Units	None	<input type="text" value="None"/>	
X1	0	mA	<input type="text" value="0"/> 0 to 20
Y1(value at X1)	0		<input type="text" value="0"/> -25000 to 25000
X2	20	mA	<input type="text" value="20"/> 0 to 20
Y2(value at X2)	1000		<input type="text" value="1000"/> -25000 to 25000
Low 1 Alarm Limit	1		<input type="text" value="1"/> Y1 to Y2
Low 1 Alarm Severity	MJ		<input type="text" value="MJ"/>
Low 1 Alarm Relay	None		<input type="text" value="None"/>
Low 2 Alarm Limit	0		<input type="text" value="0"/> Y1 to Y2
Low 2 Alarm Severity	MJ		<input type="text" value="MJ"/>
Low 2 Alarm Relay	None		<input type="text" value="None"/>
High 1 Alarm Limit	100		<input type="text" value="100"/> Y1 to Y2
High 1 Alarm Severity	MJ		<input type="text" value="MJ"/>
High 1 Alarm Relay	None		<input type="text" value="None"/>
High 2 Alarm Limit	50		<input type="text" value="50"/> Y1 to Y2
High 2 Alarm Severity	MJ		<input type="text" value="MJ"/>
High 2 Alarm Relay	None		<input type="text" value="None"/>



3. Change the following parameters as desired and click on “Set”.

- **Signal Full Name:** Name displayed in the Web Interface menus.
- **Signal Abbr Name:** Name displayed in the local display menus.
- **Signal Units:** The units being measured.
- **X1:** The lowest transducer value to be measured. Example 0 mV, 0 mA.
- **Y1(value at X1):** Lowest “Signal Units” value to be displayed when transducer measurement is at the lowest value (X1). Example when the transducer measured value is 0 mv the displayed units is 0 gallons.
- **X2:** The highest transducer value to be measured. Example 25 mV, 25 mA.
- **Y2(value at X2):** Highest “Signal Units” value to be displayed when transducer measurement is at the highest value (X2). Example when the transducer measured value is 25 mv the displayed units is 1000 gallons.
- **Low 1 Alarm Limit:** Sets the Low 1 alarm point.
- **Low 1 Alarm Severity:** Alarm level for this alarm. (See also Table 1.1 on page 3.)
- **Low 1 Alarm Relay:** Select a relay number to map to this alarm. “None” means there is no related relay number.
- **Low 2 Alarm Limit:** Sets the Low 2 alarm point.
- **Low 2 Alarm Severity:** Alarm level for this alarm. (See also Table 1.1 on page 3.)
- **Low 2 Alarm Relay:** Select a relay number to map to this alarm. “None” means there is no related relay number.
- **High 1 Alarm Limit:** Sets the High 1 alarm point.
- **High 1 Alarm Severity:** Alarm level for this alarm. (See also Table 1.1 on page 3.)
- **High 1 Alarm Relay:** Select a relay number to map to this alarm. “None” means there is no related relay number.
- **High 2 Alarm Limit:** Sets the High 2 alarm point.
- **High 2 Alarm Severity:** Alarm level for this alarm. (See also Table 1.1 on page 3.)
- **High 2 Alarm Relay:** Select a relay number to map to this alarm. “None” means there is no related relay number.

### Custom Inputs Tab

- Allows you to configure the inputs for any installed SMDUE module.

Figure 5.88 Custom Inputs Tab

Reference	Voltage Input	Fuse Alarm Input	Analog Input	Modify
Input Block 1	Enable	Enable	Transducer (0-10V)	Modify
Input Block 2	Enable	Enable	Transducer (0-10V)	Modify
Input Block 3	Enable	Enable	Shunt	Modify
Input Block 4	Enable	Enable	Shunt	Modify
Input Block 5	Enable	Enable	Transducer (0-20mA)	Modify
Input Block 6	Enable	Enable	Transducer (0-20mA)	Modify
Input Block 7	Enable	Enable	Transducer (0-10V)	Modify
Input Block 8	Enable	Enable	Transducer (0-10V)	Modify
Input Block 9	Enable	Enable	Temperature	Modify
Input Block 10	Enable	Enable	Transducer (0-20mA)	Modify

### Procedure

1. To configure the inputs for any installed SMDUE module, click on the “Modify” button for that input.
2. The following window opens.

Figure 5.89 Input Block Parameters

Function	Current Setting	New Setting
Voltage Input	Enable	See Advanced Settings > Analogs Enable
Fuse Alarm Input	Enable	See Advanced Settings > Fuses Enable
Analog Input	Transducer (0-10V)	See Advanced Settings > Analogs Transducer (0-10V) Disable Shunt Transducer (0-20mA) Transducer (0-10V) Temperature

**Set**

3. Change the following parameters as desired and click on “Set”.
  - **Voltage Input:** Enables or Disables the voltage input for that SMDUE input block. If enabled, go to Advanced Settings menu / Analogs tab to set the voltage input parameters.
  - **Fuse Alarm Input:** Enables or Disables the fuse alarm input for that SMDUE input block. If enabled, go to Advanced Settings menu / Fuses tab to set the fuse alarm input parameters.
  - **Analog Input:** Sets the analog input signal to be measured for that SMDUE input block. Choices are disable this input or measure a current transducer (0 mA to 20 mA), a voltage transducer (0 V to 10 V), or a temperature probe. Go to Advanced Settings menu / Analogs tab to set voltage or current transducer input parameters. Go to Settings menu / Temp Probes tab to set temperature probe parameters.

## Fuses Tab

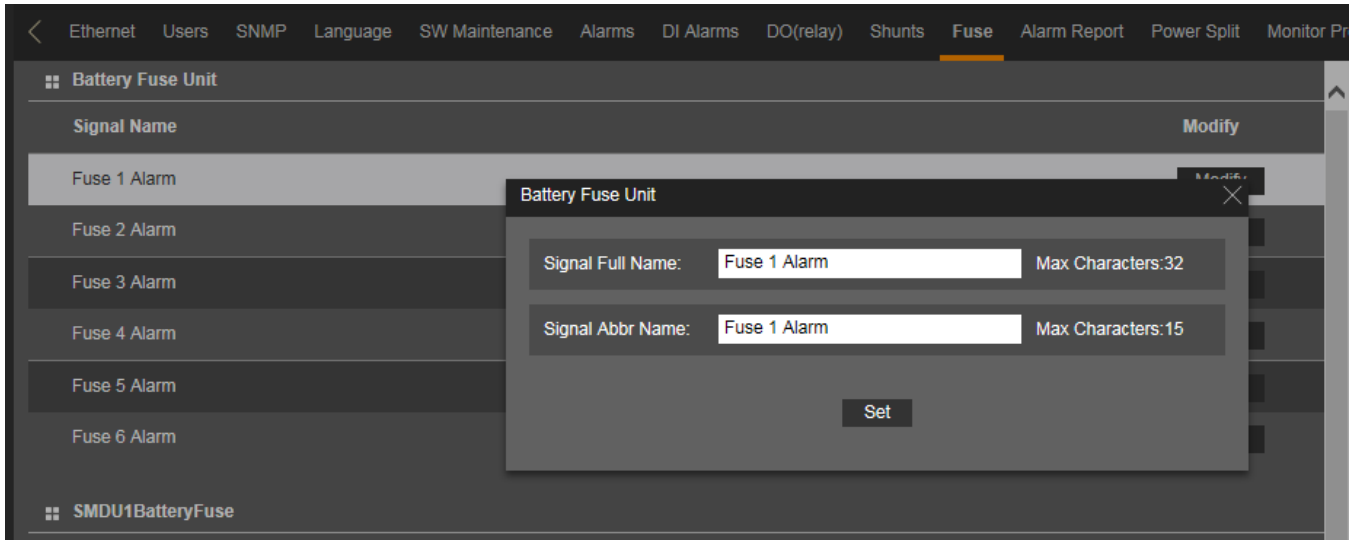
- Allows you to change the fuse full name (name displayed in the Web Interface menus).
- Allows you to change the fuse abbreviation name (name displayed in the local display menus).

Figure 5.90 Fuse Tab

Signal Name	Modify
<b>Battery Fuse Unit</b>	
Fuse 1 Alarm	Modify
Fuse 2 Alarm	Modify
Fuse 3 Alarm	Modify
Fuse 4 Alarm	Modify
Fuse 5 Alarm	Modify
Fuse 6 Alarm	Modify
<b>SMDU1BatteryFuse</b>	
Batt Fuse 1 Alarm	Modify
Batt Fuse 2 Alarm	Modify
Batt Fuse 3 Alarm	Modify
Batt Fuse 4 Alarm	Modify
Batt Fuse 5 Alarm	Modify
Batt Fuse 6 Alarm	Modify
<b>DC Fuse Unit</b>	

**Procedure**

1. To change the fuse name, click on the “Modify” button for that fuse.
2. The following window opens.

**Figure 5.91 Changing Fuse Names**

3. Change the following parameters as desired and click on “Set”.
- **Signal Full Name:** Name displayed in the Web Interface menus.
  - **Signal Abbr Name:** Name displayed in the local display menus.

## Alarm Report Tab

- In the SMTP section, you can set the Alarm Report Feature.
- In the SMS section, you can set cell phone number for receiving alarm reports and the alarm report level.



**NOTE!** A GSM modem must be connected to the USB port of the controller for SMS functionality.

Figure 5.92 Alarm Report Tab

### Alarm Report Feature

Set the following parameters.

- **Email To:** Valid email recipient to receive alarm reports.
- **Server IP:** IPV4 Server address. Obtain from your IT department.
- **Server Port:** Server port. Obtain from your IT department.
- **Email From:** The controller or Site email address. Will be displayed in the email from field of the received email.
- **Privilege:** Select Enabled (if email authentication is required) or Disabled as required (see your IT department). When enabled, set the following parameters.
  - **SMTP Account:** SMTP account number. Obtain from your IT department.
  - **SMTP Password:** SMTP password. Obtain from your IT department.
- **Alarm Report Level:** Select the level of alarm reports you want to receive.

## Generator Tab

If you have a special configuration with this feature, you can set the various generator related parameters.

Figure 5.93 Generator Tab

Signal	Value	Time Last Set	Set Value	Set
Hybrid Mode	Capacity	06/14/2018 16:15:22	Disabled	Set
DG Used for Hybrid	DG1	—	DG1	Set
DOD	40.0 %	—	20~80	Set
Equalizing Start Time	8 hh	—	0~24	Set
Start Discharge Time	19 hh	—	0~24	Set
Discharge Duration	12 h	—	1~22	Set
Hybrid High Load Setting	40.0 %	—	20~80	Set
DG Run at High Temp	Enabled	—	<input checked="" type="radio"/> Disabled <input type="radio"/> Enabled	Set
DG Run Time at High Temp	60 min	—	30~120	Set
DI for Grid	IB2-1 DI3	—	IB2-1 DI1	Set
Diesel Alarm Delay	60 s	—	30~180	Set
Fail Safe Mode(Hybrid)	NC	—	<input checked="" type="radio"/> NO <input type="radio"/> NC	Set

### Changing Programmable Parameters in the Generator Tab

To change a programmable parameter, select or enter a new value for the parameter then click on “Set” to change the value.

#### Generator Tab Programmable Parameter Descriptions

- **Hybrid Mode:** Refer to “Hybrid Control Function (Supporting Generator, Solar and Wind Energy Input, and Optimization)” on page 10 for more information on the Hybrid Mode.
  - **Disabled, Capacity, or Fixed Daily:** Sets the Hybrid Mode or disables the function.
- **DG Used for Hybrid:** Sets the diesel generator(s) to be utilized.
- **DOD:** Sets the Depth of Discharge (DOD).
- **Equalizing Start Time:** Sets the start time for equalizing.
- **Start Discharge Time:** Sets the start time for discharge.
- **Discharge Duration:** Sets the discharge duration.
- **Hybrid High Load Setting:** Sets the hybrid high load point.
- **DG Run at High Temp:** Enables or disables diesel generator operation in the high temperature condition.

- **DG Run Time at High Temp:** Sets the diesel generator run time in the high temperature condition.
- **DI for Grid:** Sets the digital input monitoring the grid.
- **Diesel Alarm Delay:** Sets diesel alarm delay.
- **Fail Safe Mode (Hybrid):** Tells the controller the fail safe mode of the relay contacts connected to start the generator(s) (either normally open or normally close).



## Power Split Tab

You can configure the advanced power split parameters and associated digital input signals. Refer to “Power Split Feature” on page 9 and “Power Split Feature” on page 46 for more information on the Power Split feature.

Figure 5.94 Power Split Tab

Power Split Mode: Disabled

Power Split

Index	Signal	Equipment	Signal Type	Signal Name	Modify
1	LVD1	NA	NA	NA	<input type="button" value="Modify"/>
2	LVD2	NA	NA	NA	<input type="button" value="Modify"/>
3	LVD3	NA	NA	NA	<input type="button" value="Modify"/>
4	BATTERY_TEST	NA	NA	NA	<input type="button" value="Modify"/>
5	EQUALIZE_CHARGE	NA	NA	NA	<input type="button" value="Modify"/>

Figure 5.95 Power Split Settings

Power Split Mode: Disabled

Power Split

Index	Signal	Equipment
1	LVD1	NA
2	LVD2	NA
3	LVD3	NA
4	BATTERY_TEST	NA
5	EQUALIZE_CHARGE	NA

LVD1

Equipment:

Signal Type:

Signal:

## **Procedure**

1. Select the power split mode (enabled or disabled). Click on SET.

## **Low Voltage Disconnect Functions**

If low voltage disconnect functions are to be used in a power split configuration, they must be implemented in the existing power system and signals from its control unit must be connected to the controller.

1. For LVD1, LVD2, and/or LVD3; click on the “Modify” button and select the controller digital inputs connected to the low voltage disconnect control circuits.
  - Set “Equipment” to the controller device connected to the existing power system low voltage disconnect control circuit.
  - Set “Signal Type” to “Sample”.
  - Set “Signal” to the digital input on the controller device selected in “Equipment” above connected to the existing power system low voltage disconnect control circuit.

## **Battery Test Function**

If the battery test function is to be used in a power split configuration, battery test must be implemented in the existing power system and a test signal from its control unit must be connected to the controller.

1. For BATTERY\_TEST, click on the “Modify” button and select the controller digital input connected to the existing systems battery test control circuit.
  - Set “Equipment” to the controller device connected to the existing power system battery test control circuit.
  - Set “Signal Type” to “Sample”.
  - Set “Signal” to the digital input on the controller device selected in “Equipment” above connected to the existing power system battery test control circuit.

## **Equalize Charge Function**

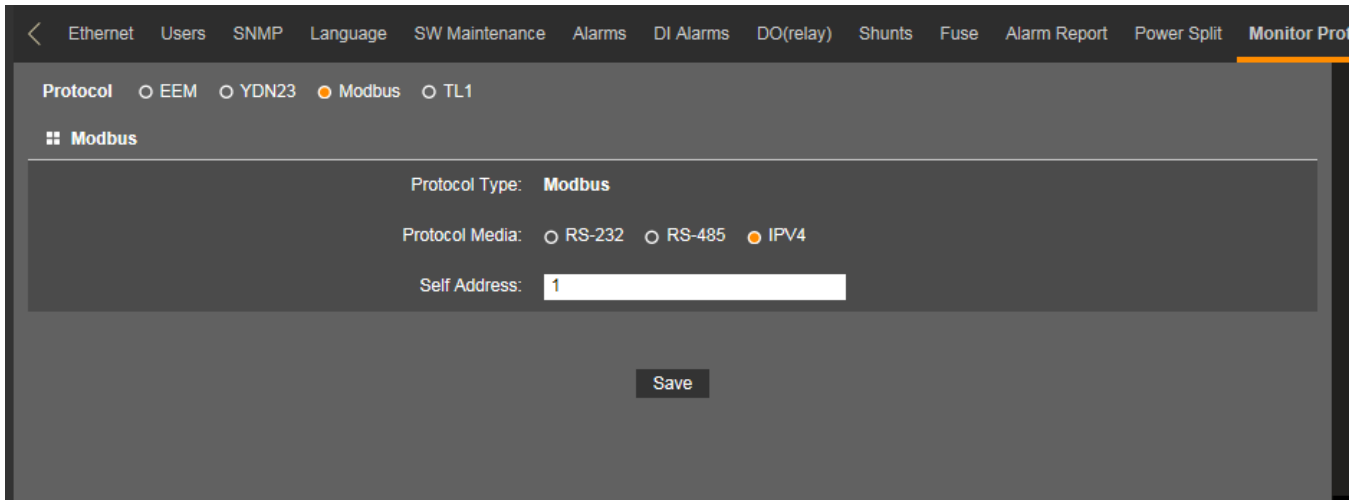
If the equalize charge function is to be used in a power split configuration, equalize charge must be implemented in the existing power system and an equalizing signal from its control unit must be connected to the controller.

1. For EQUALIZE\_CHARGE, click on the “Modify” button and select the controller digital input connected to the existing systems equalize control circuit.
  - Set “Equipment” to the controller device connected to the existing power system equalize control circuit.
  - Set “Signal Type” to “Sample”.
  - Set “Signal” to the digital input on the controller device selected in “Equipment” above connected to the existing power system equalize control circuit.

## Monitor Protocol Tab

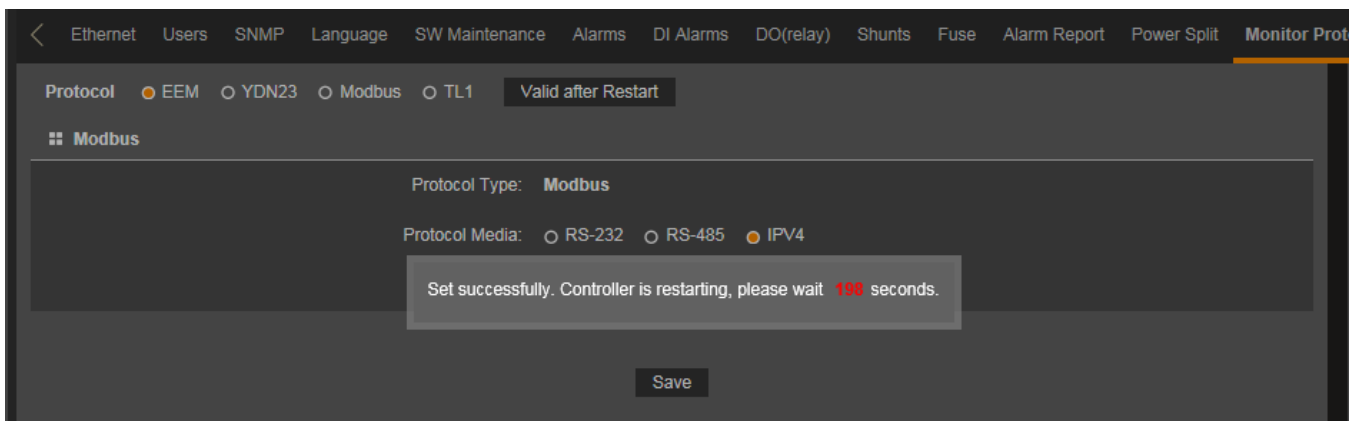
You can select "EEM", "YDN23", "Modbus" or "TL1" as the protocol. To make the new protocol valid, click the "Valid after Restart" button.

Figure 5.96 Monitor Protocol Tab



The screenshot shows the "Monitor Protocol" configuration page. At the top, there is a navigation menu with options: Ethernet, Users, SNMP, Language, SW Maintenance, Alarms, DI Alarms, DO(relay), Shunts, Fuse, Alarm Report, Power Split, and Monitor Prot. Below the menu, the "Protocol" section has radio buttons for EEM, YDN23, Modbus (selected), and TL1. Underneath, the "Modbus" section is expanded, showing "Protocol Type: Modbus", "Protocol Media: RS-232, RS-485, IPV4 (selected)", and "Self Address: 1" in a text input field. A "Save" button is located at the bottom center.

Figure 5.97 Valid after Restart



This screenshot is similar to Figure 5.96, but with the "Valid after Restart" button highlighted. A grey message box is overlaid on the page, stating: "Set successfully. Controller is restarting, please wait 100 seconds." The "Save" button is visible at the bottom.

## EEM Protocol

You can set EEM protocol parameters.

Figure 5.98 EEM Protocol

The screenshot shows the configuration page for the EEM protocol. The navigation bar at the top includes: Ethernet, Users, SNMP, Language, SW Maintenance, Alarms, DI Alarms, DO(relay), Shunts, Fuse, Alarm Report, Power Split, and Monitor Prot. The main content area is titled 'Protocol' and has radio buttons for EEM (selected), YDN23, Modbus, and TL1. Below this, there is a sub-section for 'EEM' with the following settings:

- Protocol Type:** Radio buttons for EEM (selected), RSOC, and SOC/TPE.
- Protocol Media:** Radio buttons for RS-232 (selected), Modem, IPV4, and IPV6.
- Port Parameter:** Text input field containing '9600,n,8,1'.
- Callback Enabled:** Checked checkbox.
- Report Enabled:** Unchecked checkbox.
- CCID:** Text input field containing '1', with a range indicator '【 Range 1-255 】'.
- Maximum Alarm Report Attempts:** Text input field containing '3', with a range indicator '【 Range 0-255 】'.
- Call Elapse Time:** Text input field containing '5', with a range indicator '【 Range 0-600s 】'.
- Safety Level:** Dropdown menu showing 'All commands are available.' with a downward arrow.

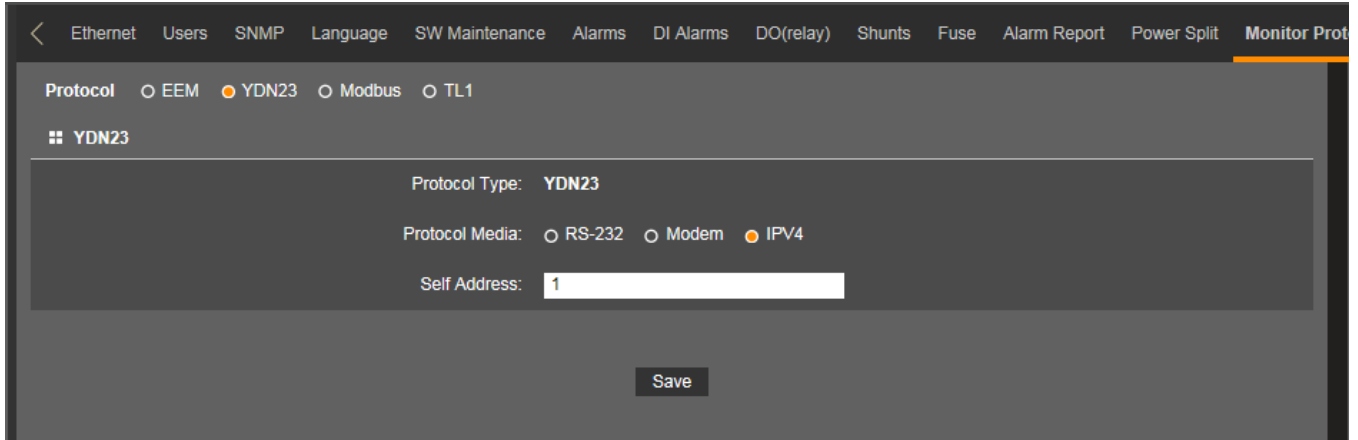
A 'Save' button is located at the bottom center of the configuration area.

- **Protocol Type:** Select EEM, RSOC, or SOC/TPE per site requirements.
- **Protocol Media:** Select RS-232, Modem, IPV4, or IPV6 per site requirements.
- **Port Parameter:** Enter the port parameters per site requirements.
- **Callback Enabled:** Select per site requirements.
- **Report Enabled:** Select per site requirements.
- **CCID:** Enter value per site requirements.
- **Maximum Alarm Report Attempts:** Enter value per site requirements.
- **Call Elapse Time:** Enter value per site requirements.
- **Safety Level:** Select per site requirements.

## YDN23 Protocol

You can set YDN23 protocol parameters.

Figure 5.99 YDN23 Protocol



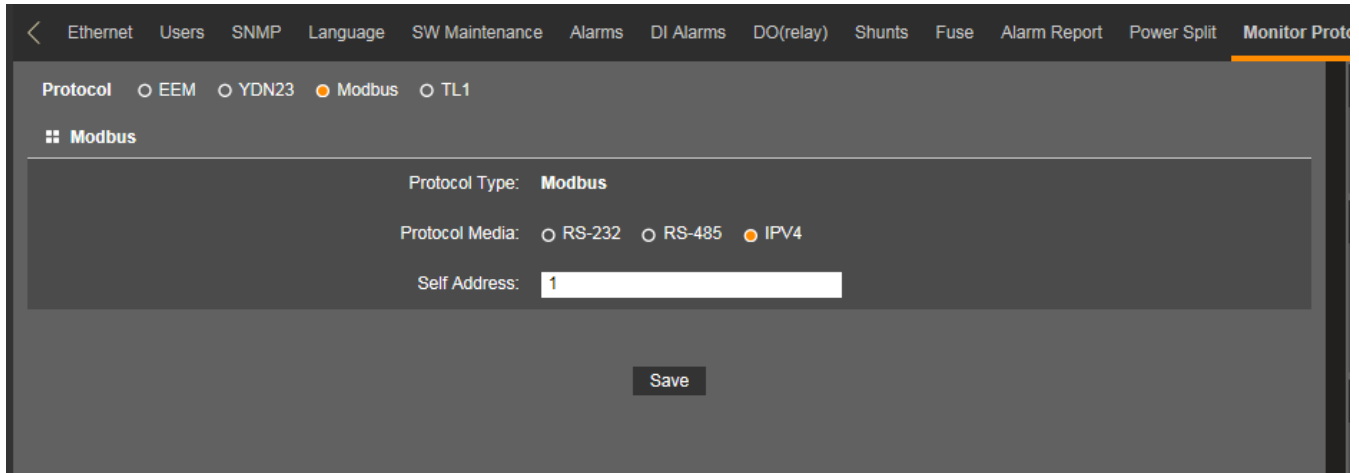
The screenshot shows a web-based configuration interface for the YDN23 Protocol. At the top, there is a navigation menu with options: Ethernet, Users, SNMP, Language, SW Maintenance, Alarms, DI Alarms, DO(relay), Shunts, Fuse, Alarm Report, Power Split, and Monitor Prot. Below the menu, there is a section for Protocol configuration with radio buttons for EEM, YDN23 (selected), Modbus, and TL1. Underneath, there is a sub-section for YDN23 with the following parameters: Protocol Type: YDN23, Protocol Media: RS-232, Modem, and IPV4 (selected), and Self Address: 1. A Save button is located at the bottom of the configuration area.

- **Protocol Media:** Select RS-232, Modem, or IPV4 per site requirements.
- **Self Address:** Enter the parameter per site requirements.

## Modbus Protocol

You can set Modbus protocol parameters.

Figure 5.100 Modbus Protocol



The screenshot shows a web application interface for configuring the Modbus Protocol. At the top, there is a navigation menu with the following items: Ethernet, Users, SNMP, Language, SW Maintenance, Alarms, DI Alarms, DO(relay), Shunts, Fuse, Alarm Report, Power Split, and Monitor Protocols. Below the navigation menu, there are radio buttons for selecting the protocol type: Protocol, EEM, YDN23, Modbus (selected), and TL1. Underneath, there is a section titled "Modbus" with a hamburger menu icon. The configuration fields are: Protocol Type: Modbus; Protocol Media: RS-232, RS-485, and IPV4 (selected); and Self Address: 1. A Save button is located at the bottom of the configuration area.

- **Protocol Media:** Select RS-232, Modem, or IPV4 per site requirements.
- **Self Address:** Enter the parameter per site requirements.

## TL1 Protocol

You can enable the TL1 port and set TL1 protocol parameters.

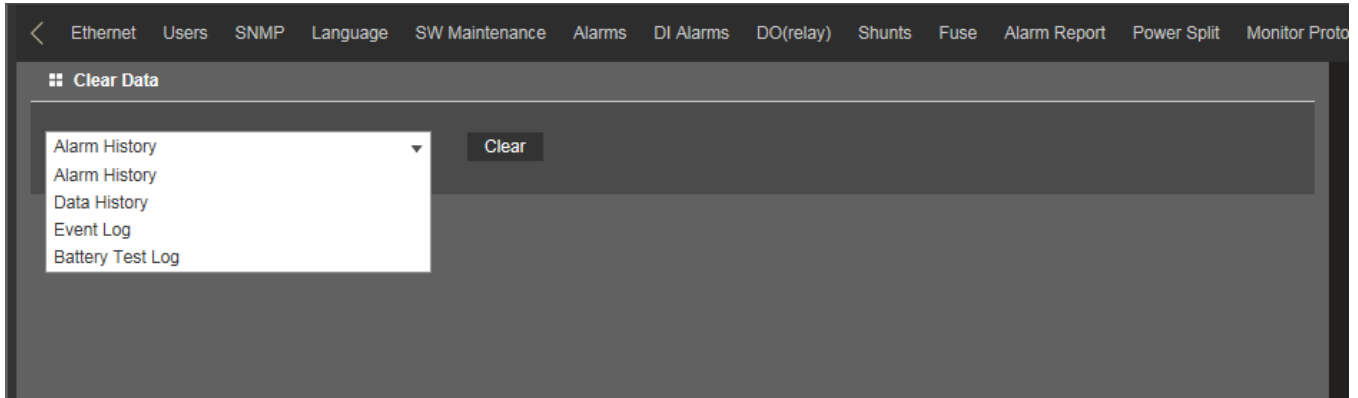
Figure 5.101 TL1 Protocol

- **Port Activation:** Select Enabled to enable the controller TL1 port. The following parameters appear.
- **Protocol Media:** Select IPV4 or IPV6 per site requirements.
- **Access Port:** This specifies the Ethernet port number through which the TL1 telnet connection is to be established. Set per site requirements.
- **Port Keep-Alive:** The controller provides an optional ‘Keep-alive’ feature. This feature ensures that the TCP connection to the remote client is maintained if desired by the User. Set per site requirements.
- **Session Timeout:** This specifies the maximum length of time in minutes that a User session can remain idle with no input received before being logged off. The telnet connection is terminated when a User session timeout occurs. Set per site requirements. Note that a “0” setting disables the session timeout feature.
- **Auto Logon User:** This specifies if a User session is automatically established for the designated User when a TL1 port connection is established. Set per site requirements. Note that a “None” setting disables this feature. The auto logon User can be set to any valid User whose name and password meet the TL1 criteria. If a User name or password is not valid, then it will not be accepted and an error message displayed to indicate this.
- **System Identifier (20 characters maximum):** ASCII string with a maximum length of twenty characters. This is a unique name which identifies the controller in an NMA system. This data parameter is used to identify the destination of command messages and the source of response and autonomous messages in an NMA system. Set per site requirements.

### Clear Data Tab

Select the data log to be cleared from those listed in the drop-down list box. Click on the “Clear” button to clear the corresponding data.

Figure 5.102 Clear Data





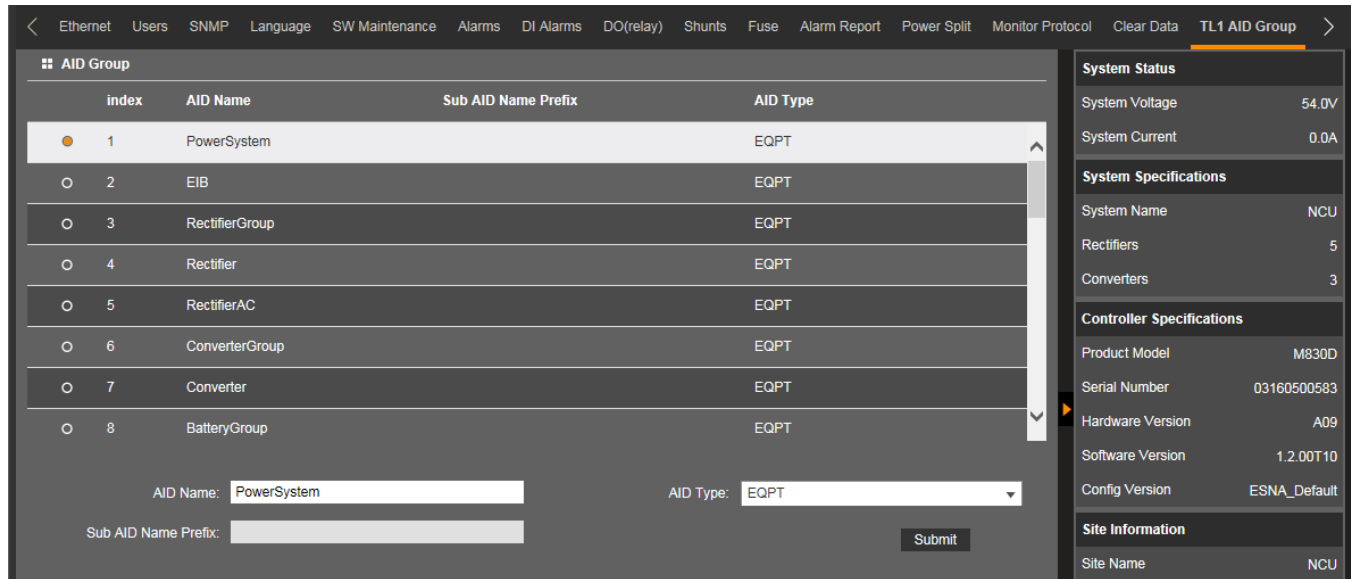
## TL1 AID Group Tab

You can program up to thirty-two (32) Access Identifiers (AID) and assign a Sub-Access Identifier (Sub- Aid) to the access identifier.

### Constraints:

- The AID Name that can also have a Sub AID Name Prefix has a 16 character maximum limit.
- The AID Name + Sub AID Name Prefix also has a 16 character maximum limit.

Figure 5.103 TL1 AID Group Tab



index	AID Name	Sub AID Name Prefix	AID Type
1	PowerSystem		EQPT
2	EIB		EQPT
3	RectifierGroup		EQPT
4	Rectifier		EQPT
5	RectifierAC		EQPT
6	ConverterGroup		EQPT
7	Converter		EQPT
8	BatteryGroup		EQPT

AID Name:  AID Type:

Sub AID Name Prefix:

### Access Identifier

In an NMA system, a unique access identifier (AID) is used to identify each entity contained within the system. The system must be configured to allow a single access identifier to be used to access and report on an NMA system entity which may consist of a multiple of sub-entities, each monitored individually by the controller. This is accomplished by configuring controller access identifiers and controller sub-access identifiers as described next. A list of access identifiers and sub-access identifiers appears in TA-NWT-001360, Table 4.1.

### Controller Access Identifier

Thirty-two (32) controller access identifiers can be programmed into the controller. The access identifier is used to uniquely identify a system entity (such as rectifiers contained in the power plant).

### Controller Sub-Access Identifier

The system sub-access identifiers are used to uniquely identify each sub-entity of an entity (such as each rectifier, each battery string, etc. contained in the power plant). This parameter applies only to TL1 commands/messages. The sub-access identifier identifies a specific sub-entity within an NMA system, such as a specific rectifier. Only alpha-numeric characters can be entered for this parameter. TL1 uses specific values for this parameter. Refer to TA-NWT-001360, Table 4.1.

### Procedure

1. Select the Access Identifier (AID) to be programmed by selecting the circle next to its number in the list.

2. Enter an “AID Name” (16 characters maximum). This name represents the AID data parameter used in TL1 commands. Valid characters are limited to alphanumeric characters.
3. Enter a “Sub AID Name Prefix” (if required). This name represents the sub-AID used in TL1 commands. Valid characters are limited to alphanumeric characters. (AID Name + Sub AID Name Prefix 16 characters maximum.)
4. Select an “AID Type”. This entry represents the type modifier used with the AID data parameter in TL1 commands. Identifies the entity represented by this access identifier either as an Equipment type or an Environment type.
  - EQPT, refers to equipment entities or entities that are part of the NMA system (ex. battery plants, rectifiers, etc.)
  - ENV, refers to environment entities or entities that are external to the NMA system (ex. air conditioners, fans, etc.)
5. Click the submit button.
6. Repeat these steps for the remaining Access Identifiers (AID).

## TL1 AID Signal Tab

This tab is used to enable/disable and configure the pre-defined TL1 signals. You can enable or disable a signal and set attributes of a signal (i.e. set condition type, condition description, notification code, etc.).



**NOTE!** TL1 signals are pre-defined. You cannot add or remove TL1 signals (just enable/disable them). You cannot change the controller signal assigned to a TL1 signal and you cannot change the AID that contains the TL1 signal.

Figure 5.104 TL1 AID Signal Tab

The screenshot displays the 'TL1 AID Signal' configuration page. At the top, there are dropdown menus for 'AID Group' (set to 'PowerSystem') and 'Equip List' (set to 'Power System'), along with a 'Sub AID Name Prefix' field. Below this, the interface is divided into two main sections. The left section, titled 'PowerSystem > Power System', contains a vertical list of signal options: 'Supervision Unit Fail', 'CAN Communication', 'Outgoing Alarms Block...', 'Maintenance Time Limi...', 'Imbalance System Curr...', 'Over Load', 'SPD', 'EStop/EShutdown', 'DHCP Failure', '485 Communication Fai...', and 'Rectifier Group Lost'. The 'Supervision Unit Fail' signal is selected. The right section, titled 'Supervision Unit Fail', contains the following configuration fields: 'Signal Active' (checked), 'Sample Signal' (HW Status), 'Alarm Signal' (Supervision Unit Fail), 'Setting Signal' (empty), 'Condition Type' (Alarm), 'Condition Description' (empty), 'Notification Code' (NA), 'Service Affect Code' (SA), 'Monitor Format' (Decimal), and 'Monitor Type' (empty). A 'Submit' button is located at the bottom right of the right section.

### Procedure

You assign signals to the TL1 access identifiers as follows.

1. Select an "AID Group" from the drop-down list. AID groups were programmed using the TL1 AID Group tab.
2. Select an "Equipment List" for this Aid Group from the drop-down list.
3. A list of signals associated to this AID Group appear in the left window pane. Select a signal in the AID Group to be configured. The AID to signal associations cannot be changed by the customer.
4. Enter the selected signal's TL1 parameters in the right window pane.

- **Signal Active:** This selects a TL1 signal to be monitored and processed for TL1 commands and reports. The field has one of two values - 'active' or 'inactive'. Setting the signal to 'active' will enable the signal for monitoring and processing of the associated alarm signals for TL1 commands and reports.
  - **Sample Signal:** This is the controller sample signal which is associated to the alarm signal. This signal is used to provide a present value (<monval>) for the TL1 signal (e.g., voltage or temperature reading). This value is used for TL1 commands and reports.
  - **Alarm Signal:** This is the alarm signal whose status is being monitored and reported.
  - **Setting Signal:** This is the controller setting signal which is associated to the alarm signal. This signal is used to provide the threshold (<thlev>) that has been exceeded to generate the alarm causing the change in state of the TL1 signal. This value is used for TL1 reports. This field is only used for alarms associated sample signals which are decimal or integer values (e.g., float, unsigned). It does not apply to signals with enumerated or digital (binary) values.
  - **Condition Type (20 characters maximum):** This is the TL1 text designating the condition corresponding to the alarm. Valid values for this parameter can contain only alphanumeric characters. TL1 uses specific values for this parameter. Refer to TA-NWT-001360 Tables 5.1 through 5.4.
  - **Condition Description (32 characters maximum):** This is a detailed text description or instructions relating to the alarm. Valid values for this parameter can contain only alphanumeric characters. May also be used to describe any action to be taken as a result of the condition.
  - **Notification Code:** This is the TL1 notification code for the associated alarm. It should mirror the alarm severity. Values are CR (critical), MJ, (Major), MN (Minor), NA (Non-alarmed), and NR (Non-reporting).
    - CR - Critical Alarm
    - MJ - Major Alarm
    - MN - Minor Alarm
    - NA - Not Alarmed
    - NR - Not Reported When Event Occurs
  - **Service Effect Code:** This is the TL1 service effect code for this alarm. Values are SA (service affecting) and NSA (Non-Service Affecting).
    - SA = service-affecting condition, immediate action required
    - NSA = nonservice-affecting condition, action required
  - **Monitor Value Format (I or D):** This specifies the format of the monitored value (monval). Values are integer (I) and decimal (D).
  - **Monitor Type (10 characters maximum):** This is the type of parameter being monitored. It should indicate the units of measurement of the sample signal. This field is only used for sample signals that are decimal or integer values (e.g., float, unsigned) and does not apply to signals with enumerated or digital (binary) values. Only alpha characters can be entered for this parameter. TL1 uses specific values for this parameter. Refer to TA-NWT-001360 Table 6.1.
5. Click the Submit button.
  6. Repeat these steps for other signals to be added to the AID group and to assign signals to other AID groups.

## 6 Accessing the Controller via a Network Management System (NMS)

### 6.1 General

The controller has an SNMP agent function.

Users can use a Network Management System (NMS) to perform the following operations:

- Query the operation status and input/output signals of the devices connected to the controller.
- Browse the active alarms.
- Set the float voltage.
- Set the battery current limit.
- Read Ah Battery Capacity
- Set Battery Equipment Rated Capacity

When the controller generates alarms, the SNMP agent can be configured to notify the NMS through TRAPS automatically.

### 6.2 NMS Supported by SNMP Agent

SNMP is a technology used for network management. The technology is based on implementing an information base called MIB (Managed Information Base). This MIB contains parameters that are of interest from a management perspective. All LAN connected equipment that supports SNMP also supports a default MIB called MIB-II.

The SNMP Agent responds to requests received via the SNMP protocol and also actively sends TRAPS to a specified manager when certain MIB values change state. This is used to actively inform a manager when an alarm situation is recognized.

#### 6.2.1 NMS Supported by SNMP v2

The SNMP agent of the controller supports SNMPv2.

All the NMS that supports SNMPv2c can be used to access the controller. The NMS includes HP OpenView, IBM NetView, Novell ManageWise, SunNet Manager, and so on.

#### 6.2.2 NMS Supported by SNMP v3

The controller has SSL and SNMP V3 function, which makes the controller more powerful and more secure.

With SSL, you can browse/set the Webpage with https. If your site requires secure HTTP and you were furnished with a controller configuration with secure HTTP, enter https:// and the controller's IP address and press **ENTER**. Data is encrypted in the transmission. You can also browse/set the MIB library with SNMP v3. Data is also encrypted in the transmission.



### 6.2.3 Parameter Setting in SNMP Manager

The screenshot shows the 'Snmp Config' dialog box with the 'Snmp V3 Parameters' tab selected. The 'User Settings' section is expanded, showing the following fields:

- Configuration: NewCfgl (dropdown), New, Delete (button)
- Context ID: (empty text box), Context Name: (empty text box)
- User Settings:
  - User Name: admin (dropdown), New, Delete (button)
  - Security Level: AuthPriv (dropdown)
  - Priv Proto: DES (dropdown), Priv Pwd: (password field with asterisks)
  - Auth Proto: MD5 (dropdown), Auth Pwd: (password field with asterisks)
- Save, Cancel (buttons)

Annotations with arrows point to the following fields:

- User Name: admin → The User permitted to access the agent.
- Security Level: AuthPriv → The get/set data security level (NoAuthNoPriv, AuthNoPriv, or AuthPriv).
- Priv Pwd: (password field) → The private DES password used to encrypt the data.
- Auth Pwd: (password field) → The authorization MD5 password used to encrypt the digital signature.

**NOTE!** For SNMP v3, the security level for Get/Set/Walk operations is set to "AuthPriv" and cannot be adjusted.

## 6.3 MIB Installation

### 6.3.1 Installation

The Controller's MIB is named "Netsure.mib". Contact your Vertiv representative for the location on the Web to download the MIB file.

Use the MIB loading function of the NMS to load the MIB database. Refer to the User Manual provided with the NMS for the detailed loading method.

### 6.3.2 Contents of the Controller's MIB

The contents of the MIB supported by the controller's SNMP agent and the OID are listed in Table 6.1. For the details, refer to the MIB file named "Netsure.mib".

## 6.4 Accessing the Controller through an NMS

### 6.4.1 Apply Administrative Privilege

In order to use the NMS to manage the devices connected to the controller, the administrative authority needs to be applied for the NMS, that is, add the NMS information to the access list of SNMP agent.

#### **Add NMS through Web Browser**

Refer to "NMSV2 Configuration Description (Network Management System)" on page 177 and "NMSV3 Configuration Description (Network Management System)" on page 179 for the method of adding NMS.

## 6.5 ESR Configure

**The EEM Protocol** is used for communication between the Main Computer and the controller. The Main Computer is the computer superior to the controller (the client of the controller). On this page, all parameters needed for communication with a main EEM computer are to be set.

**User Information Configuration:** On this page, Users, their privilege and password are configured.

**Time Synchronization:** On this page, the system time and date are to be set.

Automatic time synchronization from time servers can also be configured.

**Table 6.1 Contents of the Controller's MIB****Table 6.1**

<b>Identification Group</b>		
identManufacturer	The name of the equipment manufacturer.	R
identModel	The manufacturers model designation of the power system.	R
identControllerFirmwareVersion	The firmware (software) version of the controller.	R
identName	The name of the power plant. This object should be set by the administrator.	R/W
identSNMPCfgVer	The SNMP configuration version.	R
identControllerSerialNumber	The serial number of this controller.	R
<b>System Group</b>		
systemStatus	Status of the complete plant (highest alarm). One of.. (1) unknown - status has not yet been defined (2) normal - there are no activated alarms (3) warning - OA, lowest level of 'abnormal' status (4) minor - A3 (5) major - MA (6) critical - CA, highest level of 'abnormal' status (7) unmanaged (8) restricted (9) testing (10) disabled	R
systemVoltage	System voltage, stored as mV, including positive or negative sign.	R
systemCurrent	System current, stored as mA, including positive or negative sign.	R
systemUsedCapacity	Used capacity, stored as percentage of the total capacity.	R
<b>Battery Group</b>		
psBatteryVoltage	Battery voltage, stored as mV, including positive or negative sign.	R
psTotalBatteryCurrent	Battery current, stored as mA, including positive or negative sign.	R
psLowestBatteryCapacity	Calculated capacity, stored as % of the total capacity. Lowest available capacity for multiple battery strings.	R
<b>Battery Table</b>		
psBatteryIndex	Automatically generated index object.	R
psBatteryCurrent	Battery current in mA.	R
psBatteryName	Battery shunt name.	R
psBatteryCapacity	Battery capacity in Ah.	R
psBatteryCapacityPercent	Battery capacity in percent.	R
psBatteryRatedCapacity	Battery capacity in Ah*1000.	R/W
<b>Input Group</b>		
psInputLineAVoltage	The AC line A voltage, stored as mV.	R
psInputLineBVoltage	The AC line B voltage, stored as mV.	R
psInputLineCVoltage	The AC line C voltage, stored as mV.	R
psInputPhaseACurrent	The AC Phase A current, stored as mA.	R
psInputPhaseBCurrent	The AC Phase B current, stored as mA.	R
psInputPhaseCCurrent	The AC Phase C current, stored as mA.	R



Table 6.1

Temperature Group		
psTemperature1	The first route temperature, stored as 0.001 Celsius degree.	R
psTemperature2	The second route temperature, stored as 0.001 Celsius degree.	R
Temperature Table		
psTemperatureIndex	Temperature probe number.	R
psTemperatureMeasurement	Temperature Value in degrees Centigrade * 1000.	R
psTemperatureName	Configured temperature probe name.	R
psTemperatureType	Temperature Probe Type.	R
psTemperatureAlarmStatus	Temperature Probe Alarm Status.	R
psStatusCommunication	The status of communication with the Power System.	R
Battery Mode		
psStatusBatteryMode	The status of battery modes. FloatCharging (2), ShortTest (3), BoostChargingForTest (4), MnualTesting (5), PlanTesting (6), ACFailTesting (7), ACFail (8), ManualBoostCharging (9), AutoBoostCharging (10), CyclicBoostCharging (11), MasterBoostCharging (12), MasterBaterlyTesting (13).	R
SM Series Group		
psSMACNumber	The number of SM AC module.	R
psSMBATNumber	The number of SM BAT module.	R
psSMIONumber	The number of SM IO module.	R
Rectifier Group		
psNumberOfInstalledRectifiers	Number of rectifiers.	R
psNumberOfRectifiersCommunicating	Number of rectifiers communicating.	R
psRectifiersUsedCapacity	Used capacity, stored as % of the total capacity.	R
Rectifier Table		
psRectifierIndex	Automatically generated index object.	R
PsRectifierProductNumber	Rectifier product number.	R
PsRectifierHWVersion	Rectifier hardware revision.	R
psRectifierSWVersion	Rectifier software revision.	R
psRectifierSerialNumber	Rectifier serial number.	R
psRectifierCurrent	Rectifier current.	R
psRectifierIdent	Rectifier physical location identifier.	R
psRectifierFail	The type of alarm change. One of.. (1) Activated (2) Deactivated	R

**Table 6.1**

<b>Distribution Load Table</b>		
psDistributionLoadCurrent	Distribution current in mA.	R
psDistributionLoadName	Distribution name.	R
<b>Distribution General Table</b>		
psDistributionGeneralCurrent	Distribution current in mA.	R
psDistributionGeneralName	Distribution name.	R
<b>Converter Group</b>		
numberOfInstalledConverters	Number of converters.	R
numberOfConvertersCommunicating	Number of converters communicating.	R
convertersUsedCapacity	Used capacity, stored as % of the total capacity.	R
psConverterVoltage	Converter voltage in mV.	R
psTotalConverterCurrent	Total converter current in mA.	R
<b>Converter Table</b>		
psConverterIndex	Automatically generated index object.	R
psConverterProductNumber	Converter product number.	R
psConverterHWVersion	Converter hardware revision.	R
psConverterSWVersion	Converter software revision.	R
psConverterSerialNumber	Converter serial number.	R
psConverterCurrent	Converter current.	R
psConverterIdent	Converter physical location identifier.	R
psConverterFail	The type of alarm change. (1) activated (2) deactivated	R
<b>Control Group</b>		
controlBatteryTest	Control battery test, start (1), stop (0).	R/W
controlRelay8	Control relay8, close (1), open (0).	R/W
controlRelay7	Control relay7, close (1), open (0).	R/W
controlRelay6	Control relay6, close (1), open (0).	R/W
controlRelayTest	Control relay test, auto (2), manual (1), disabled (0).	R/W
<b>Equipment Signal Table</b>		
psEquipmentSignalTableEntryIndex	The unique sequence number of this equipment signal.	R
psEquipmentSignalValue	Indexed equipment signal value.	R
<b>Setting Group</b>		
settingFloatVoltage	Float voltage setting in mV.	R/W
settingEQChargeVoltage	Equalize charge voltage stored as mV.	R/W
settingBatteryCurrentLimit	Battery charge current limit stored as thousandths of C10.	R/W
settingResetBatteryCapacity	Reset Battery Capacity.	R/W
settingAutoEqualize	Automatic Equalize, disabled (0), enabled (1)	R/W
settingEQStartCurrent	Equalize start current stored as thousandths of C10.	R/W

**Table 6.1**

settingEQStartCapacity	Auto Equalize start capacity in percent.	R/W
settingEQStopCurrent	Equalize stop current stored as thousandths of C10.	R/W
settingEQStopDelay	Equalize stop delay time stored as minutes.	R/W
settingMaxEQChargeTime	Maximum equalize charge time stored as minutes.	R/W
settingSolarMode	Solar mode, disabled (0), rect-solar (1), solar (2)	R/W
settingSolarFloatVoltage	Solar float voltage stored as mV.	R/W
settingSolarEQChargeVoltage	Solar equalize voltage stored as mV.	R/W
settingRectifierFloatVoltage	Rectifier Float voltage stored as mV.	R/W
settingRectifierEQChargeVoltage	Rectifier Equalize voltage stored as mV.	R/W
settingGeneratorFunction	Automatic Generator Control, disabled (0), voltage (1), batterycapacity (2)	R/W
settingGeneratorStartVoltage	Generator start voltage stored in mV.	R/W
settingGeneratorManualStart	Generator Manual Start, disabled (0), active (1)	R/W
settingGeneratorStartCapacity	Battery capacity in % * 1000.	R/W
settingDIforGenerator	Digital input for Generator, None (0), DI2 (1), DI3 (2), DI4 (3), DI5 (4), DI6 (5), DI7 (6)	R/W
settingUtilityPowerPresent	Utility Power is present, No (0), Yes (1)	R/W
settingBatteryCurrentLimitEnable	Battery Current Limit Enable, Disabled (0) Active (1)	R/W
settingRectifierCurrentLimitEnable	Rectifier Current Limit Enable Disabled (0) Active (1)	R/W
settingRectifierCurrentLimit	Rectifier current limit stored as mA.	R/W
settingCalculateBatteryCurrent	Calculate Battery Current No (0) Yes (1)	R/W

**Table 6.1**

settingTemperatureCompProbe	Temperature Compensation Probe None (0) Maximum Probe Temperature (1) Average Probe Temperature (2) Minimum Probe Temperature (99) System Temp1 (4) System Temp2 (5) System Temp3 (6) IB2-1 Temp1 (7) IB2-2 Temp2 (8) EIB1 Temp1 (9) EIB1 Temp2 (10)	R/W
<b>Alarm Trap Counter</b>		
alarmLastTrapNo	The sequence number of last submitted alarm trap, also last row in alarmTrapTable.	R
<b>Active Alarm Table</b>		
alarmIndex	The unique sequence number of this alarm trap.	R
alarmTime	Date and time when event occurred (local time), including timezone if supported by controller.	R
alarmStatusChange	The type of alarm change. One of... (1) activated (2) deactivated	R
alarmSeverity	The severity of the alarm. One of... (3) warning - OA, lowest level of alarm severity (4) minor - A3 (5) major - MA (6) critical - CA, highest level of alarm severity	R
alarmDescription	Free-text description of alarm.	R
alarmType	Alarm type, i.e. an integer specifying the type of alarm.	R
<b>Events/Traps</b>		
alarmTrap	An alarm trap is sent when an alarm occurs (activated) or returns to normal state (deactivated). Alarm traps are logged in alarmTrapTable. Variables in this trap: * alarmIndex The unique sequence number of this alarm trap. * alarmTime Date and time when event occurred (local time), including timezone if supported by controller. * alarmStatusChange (1) activated or (2) deactivated. * alarmSeverity Integer describing the severity of the alarm. * alarmDescription Free-text description of alarm. * alarmType Integer indicating type of alarm.	--
alarmActiveTrap	An alarm trap is sent when an alarm occurs (activated). Variables in this trap: * alarmTime Date and time when event occurred (local time), including timezone if supported by controller. * alarmSeverity Integer describing the severity of the alarm. * alarmDescription Free-text description of alarm. * alarmType Integer indicating type of alarm.	--

**Table 6.1**

alarmCeaseTrap	<p>An alarm trap is sent when an alarm returns to normal state (clear, deactivated). Variables in this trap:</p> <ul style="list-style-type: none"> <li>* alarmTime Date and time when event occurred (local time), including timezone if supported by controller.</li> <li>* alarmSeverity Integer describing the severity of the alarm.</li> <li>* alarmDescription Free-text description of alarm.</li> <li>* alarmType Integer indicating type of alarm.</li> </ul>	--
----------------	---	----

In Table 6.1, R means OID is read-only (GET), and R/W means OID can be read and modified (GET/SET).

## 7 Accessing the Controller via TL1

### 7.1 Accessing the TL1 Port

#### 7.1.1 Port Connection

- Connection to the TL1 interface is made through the controller's Ethernet port by establishing a telnet session (not SSH) to the Ethernet port number specified by the controller's "TL1 Ethernet Access Port" setting. The TL1 port is the Ethernet port located on the front of the controller, unless the system contains an IB4 board; then the TL1 port is the Ethernet port located on the IB4 board.
- The telnet connection through the Ethernet port must always be established by the remote User. The controller does not initiate a telnet session under any circumstances.
- To access the TL1 interface the User must log on using the 'ACT-USER' command detailed under "ACTIVATE-USER (ACT-USER)" starting on page 238 or an auto-login User must be configured (see "TL1 Protocol" on page 217). No response other than the prompt will be given for any input received prior to a valid User session being established.
- Only one telnet connection through the port assigned for the TL1 interface is allowed at any time.
- The telnet connection is disabled when the TL1 interface is not selected by the customer. The telnet connection is considered disabled when all telnet ports indicate closed during a network scan of the Ethernet connection.

#### 7.1.2 TL1 Port Connection Keep-Alive Feature

The controller provides an optional 'Keep-alive' feature. This feature ensures that the TCP connection to the remote client is maintained if desired by the User. Below are the requirements for this feature.

- Signal is a TCP 'keep-alive' signal and can be enabled or disabled.
- A keep-alive probe packets are sent at five second intervals. A maximum of four probe packets are sent.

### 7.2 TL1 User Session

#### 7.2.1 Establishing a Session

- The User must log on using the 'ACT-USER' command.
- Only one User session is supported at a time.
- If a second User attempts a valid logon when a User has already established a valid session, the second User becomes the User that is logged on.
- If a second User attempts a logon that fails, the User session is closed for the User that was previously logged on. A new User session must then be established if necessary. The telnet connection remains open and autonomous messages will still be sent.
- Once a valid TL1 port User session is established, valid request messages will be accepted.

#### 7.2.2 TL1 Autonomous Messages

- Autonomous TL1 messages are outputted through the TL1 port whenever one is pending and there is a valid port connection.
- If the TL1 port connection is not present, then the data is maintained and outputted when a port connection becomes present.

## 7.3 TL1 Port Configuration

Refer to “TL1 Protocol” on page 217.

## 7.4 TL1 Commands, Autonomous Messages, and Error Codes Supported by the Controller

This section lists the specific TL1 commands and autonomous messages (in alphabetical order) the controller supports. Also provided is a list of error codes for the TL1 commands supported.



**NOTE!** The controller does not currently support parameter grouping in TL1 commands.



**NOTE!** In response messages, only the completion codes ‘COMPLD’ and ‘DENY’ are used.

### 7.4.1 Format Overview of Required TL1 Messages

#### Command Message Overview

This tables summarize the format of the supported TL1 requests.

verb[-modifier[-modifier]:[<tid>]:[<aid>]:<ctag>[:[general block]:[input parameter blocks]];

Verb-modifier(s)	Description	<tid>	<aid>	<ctag>	general block	parameter blocks
ACT-USER	User logon request.	<null> or the system identifier	User-id	Correlation tag	not used	Password
CANC-USER	User logoff request.		User-id			not used
RTRV-ALM- {ALL EQPT}	Requests all alarms or only those specified in parameter blocks.		ALL or specified			varies
RTRV-EQPT	Requests information on specified equipment.		ALL or SYSTEM			not used
RTRV-HDR	Requests a system header message.		<null>			not used
REPT-ALM-EQPT	Report of alarms as they occur and clear.		--			varies
CANCEL-SESSION	User timeout message.		<null>			not used

**Command Response Overview**

This table summarizes the TL1 responses sent by the controller.

```
cr lf lf
^^^<source identifier>^<date>^<time> cr lf
M^^<ctag>^COMPLD[ cr lf
^^^<response parameter blocks>"] cr lf;
```

<source identifier> is the system identifier

<ctag> is the <ctag> copied from the request

Request Verb	<response parameter blocks>
ACT-USER	/* This is a private computer system. cr lf Unauthorized access may result in criminal prosecution */
CANC-USER	<null>
RTRV-ALM-{ALL EQPT}	Alarm details.
RTRV-EQPT	Controller part number, controller software version, etc.
RTRV-HDR	<null>

**Autonomous Message Overview**

This table summarizes the TL1 autonomous message sent by the controller.

```
cr lf lf
^^^<source identifier>^<date>^<time> cr lf
<almcde>^<atag>^verb[^modifier[^modifier] cr lf
<rspblk> + ;
```

<almcde> is the alarm code (\*C for Critical Alarm, \*\* = Major Alarm, etc.)

<atag> is the autonomously generated ID (like a sequence number)

<rspblk> is the detailed information about the alarm; see details below.

Verb	<response parameter blocks>
REPT-ALM-EQPT	Alarm details.
CANCEL-SESSION	<null>



## 7.4.2 Samples

### TL1 Message Samples

These samples use the system identifier (<tid>): Lorain.

#### Autonomous Message on Connect

When the Telnet connection is established, the controller will provide the active alarms in an autonomous message. In this example, there are two alarms.

```
Lorain 15-09-24 13:47:00
*C 1 REPT ALM EQPT
  "PowerSystem:CR,Alarm,SA,09-24,13-45-31,,1,,1-MIN:\CAN Communication Failure\","
  "PowerSystem:CR,Alarm,SA,09-23,13-39-43,,1,,1-DAY:\SPD\","
;
<
```

#### Activate User

The ACT-USER request (example: ACT-USER::drw:51:1\_2345; for username drw with password 1\_2345) can be used to log in. The controller will not respond to requests unless a user is logged in (or the controller is configured with auto-login). The controller responds with this message:

```
Lorain 15-09-24 15:29:14
M 51 COMPLD
/* This is a private computer system.
Unauthorized access may result in criminal prosecution */
;
<
```

#### Cancel User

The CANC-USER request (example: CANC-USER:Lorain:drw:16; for username drw) can be used to log-out the current user. The controller responds with this message:

```
Lorain 15-09-25 08:18:04
M 16 COMPLD
;
<
```

#### Retrieve Header

The RTRV-HDR request (example: RTRV-HDR::20;) can be used to 'ping' the controller to confirm that there is a connection established. The controller responds with this message:

```
Lorain 15-09-25 08:17:57
M 20 COMPLD
;
<
```

#### Retrieve Equipment

The RTRV-EQPT request (example: RTRV-EQPT:Lorain:SYSTEM:40;) can be used to get information about the controller. The controller responds with this message:

```
Lorain 15-09-25 08:17:55
M 40 COMPLD
"SYSTEM:M830B::SWVER=1.00,CURSWVER=1.1.41T04,:IS-NR,"
;
<
```

The controller type is M830B. The configuration is version 1.00. The software version is 1.1.41T04.

### Retrieve Alarms

The RTRV-ALM-ALL request (example: RTRV-ALM-ALL::ALL:53::;) can be used to retrieve all alarms. The controller responds with this message:

```
Lorain 15-09-24 15:29:35
M 53 COMPLD
"PowerSystem,EQPT:CR,ConditionType,SA,09-24,15-22-54,,,6-MIN:\\"ConditionDescription\","
"PowerSystem,EQPT:CR,Alarm,SA,09-23,13-39-43,,,1-DAY:\\"SPD\","
"PowerSystem,EQPT:CR,Alarm,SA,09-24,15-24-53,,,4-MIN:\\"Under Voltage 2\","
"RectifierGroup,EQPT:CR,Alarm,SA,09-24,15-25-12,,,4-MIN:\\"Rectifier Lost\","
;
<
```

In this case there are 4 critical, service-affecting alarms. The description of the first alarm was changed to show how the Condition Type and Condition Description are used. See Section 4.1.

The RTRV-ALM-ALL request can be used to filter the alarms and retrieve a subset of the alarms (example: RTRV-ALM-EQPT::ALL:57::CR; to get the CR critical alarms). The controller responds with this message:

```
Lorain 15-09-25 08:17:59
M 57 COMPLD
"PowerSystem,EQPT:CR,ConditionType,SA,09-25,07-52-54,,,25-MIN:\\"ConditionDescription\","
"PowerSystem,EQPT:CR,Alarm,SA,09-23,13-39-43,,,1-DAY:\\"SPD\","
"PowerSystem,EQPT:CR,Alarm,SA,09-25,07-54-58,,,23-MIN:\\"Under Voltage 2\","
"RectifierGroup,EQPT:CR,Alarm,SA,09-25,07-55-12,,,22-MIN:\\"Rectifier Lost\","
;
<
```

### Error Response

The controller will respond with an error message if there are any issues with the request. (Note that the controller will not respond if the system identifier does not match or if the user is not logged in.)

Here is an example of the controller response when an invalid command (RTRV-ALM-EQPTX::ALL:57::CR;) is sent:

```
Lorain 15-09-25 08:18:15
M 57 DENY
ICNV
/* Command not valid */
;
<
```

### TL1 Autonomous Message Sample

The DI1 alarm occurs.

```
5 CA ✖ Power System SPD ▾ 2015/09/23 13:39:43
```

When the alarm occurs, the controller sends this autonomous message:

```
LorainLab 15-09-24 13:49:42
*C 8 REPT ALM EQPT
  "PowerSystem:CR,Alarm,SA,09-24,13-49-41,,0,0,0-MIN:\"DI1 Alarm\", "
;
<
```

When the alarm clears, the controller sends this autonomous message:

```
LorainLab 15-09-24 13:50:06
A 9 REPT ALM EQPT
  "PowerSystem:CL,Alarm,SA,09-24,13-50-06,,0,1,0-MIN:\"DI1 Alarm\", "
;
<
```

## 7.4.3 Table of TL1 Commands Supported

Refer to Table 7.1 for a list of all TL1 commands supported, with a short description of each command.

**Table 7.1 TL1 Commands Supported**

TL1 Commands Supported	Description
ACTIVATE-USER ACT-USER	Sets up a session with the system (i.e., logging into the system).
CANCEL-USER CANC-USER	Terminates a session with the system (i.e., logging off of the system).
RETRIEVE-ALARM RTRV-ALM- {EQPT   ALL }	Instructs the system to send the current state of its alarm conditions associated with one or more equipment units, facilities, etc. within the system.
RETRIEVE-EQUIPMENT RTRV-EQPT	Instructs the system to send the current controller software version and the controller software configuration part number and revision.
RETRIEVE-HEADER RTRV-HDR	Requests that the system reply with a "normal" response indicating COMPLD.

## 7.4.4 Expanded Description of TL1 Commands Supported (in alphabetical order)

This section lists the specific TL1 commands (in alphabetical order) the controller supports and provides a broader description of the command.

### **ACTIVATE-USER** **(ACT-USER)**

**Referenced In:** TR-NWT-000835, Issue 3; pg. 3-23

**General Description:** This command is for setting up a session with the NE (controller) [i.e., logging into the NE (controller)]. An entry is made in the controller's event log indicating this command was executed by the User who initiated the command. The event description indicates that a User session was established and also identifies the User who executed the command.

When a valid User session has been previously established and this command is entered with a valid User name (<uid>) and password (<pid>), the User specified in the command becomes the User that is logged on. An entry is made in the controller's event log as stated above.

The User name and password parameters entered with this command are checked against the controller's list of Users.

It is the responsibility of the person adding a User to the controller's User list to insert values for the User name and password fields that are compatible with the operation of the TL1 interface. It is the responsibility of the controller software to ensure that User name and password values entered with this command meet the requirements of the TL1 interface.

**Controller Access Level:** any access level

#### **Input Format:**

```
ACT-USER:[<tid>]:<aid>:<ctag>::<pid>;
```

```
<aid>
```

For this command, the access identifier is the User name (<uid>). Invalid values received for this parameter return an error response with the error code IIAC.

```
<pid>
```

This is the **private identifier** (i.e., password) of the User who is attempting to gain access.

#### **Normal Response Format:**

```
cr lf lf
```

```
^^<source identifier>^<date>^<time> cr lf
```

```
M^^<ctag>^COMPLD cr lf
```

```
^^/* This is a private computer system. cr lf
```

```
Unauthorized access may result in criminal prosecution */ cr lf;
```

**CANCEL-USER**  
**(CANC-USER)****Referenced In:** TR-NWT-000835, Issue 3; pg. 3-33**General Description:** This command is for terminating a User session [i.e., logging off of the NE (controller)].**Controller Access Level:** any access level**Input Format:**

CANC-USER:[&lt;tid&gt;]:&lt;aid&gt;:&lt;ctag&gt;;

&lt;aid&gt;

For this command, the access identifier is the User identifier(<uid>). Invalid values received for this parameter return an error response with the error code IIAC.

**Normal Response Format:**

No response is returned if a valid User session has not been established. Otherwise the response is in the following format.

cr lf lf

^^&lt;source identifier&gt;^&lt;date&gt;^&lt;time&gt; cr lf

M^^&lt;ctag&gt;^COMPLD cr lf

## **RETRIEVE-ALARM (RTRV-ALM-{EQPT|ALL})**

**Referenced In:** TR-NWT-000833, Issue 5; pg. 4-205

**General Description:** Instructs the NE (controller) to send the current state of its alarm conditions associated with one or more equipment units, facilities, etc. within the NE (controller).

**Controller Access Level:** any access level

### **Input Format:**

RTRV-ALM-{EQPT|ALL}:

[<tid>]:<aid>:<ctag>:[<ntfncdc>],[<condtype>], [<srveff>],[<locn>],[<dirn>][<tmper>];



**NOTE!** The command code modifier of COM is not supported. If specified, an error response with the error code ICNV is returned.

<aid>

A value of ALL requests retrieval of alarm conditions for all AIDs of the type defined by the command code modifier. Use of the command code modifier ALL results in retrieval of all alarm conditions in the NE (controller).

If the command code modifier is ALL, the <aid> must be ALL. A <null> value is not permitted for this parameter.

<ntfncdc>

This is the notification code associated with the alarm conditions being retrieved. Valid values for this parameter are as follows:

CR	critical alarm
MJ	major alarm
MN	minor alarm
<null>	request retrieval of alarm conditions for all of the above codes

<condtype>

This is the condition type of alarm conditions to be retrieved. A <null> value causes all conditions classified as alarm conditions to be retrieved.

<srveff>

This is the effect on service caused by the alarm condition. Valid values for this parameter are as follows:

SA	service-affecting condition
NSA	nonservice-affecting condition
<null>	request retrieval of alarm conditions for both of the above codes

<locn>

This is the location of the alarm condition. This parameter does not apply to this application. A <null> value is the only value which is accepted for this parameter. If any other value is received for this parameter, an error response is returned with the error code INUP.

<dirn>

This is the direction of the alarm condition. This parameter does not apply to this application. A <null> value is the only value which is accepted for this parameter. If any other value is received for this parameter, an error response is returned with the error code INUP.

<tmper>

This is the accumulation time period for PM parameters. This parameter does not apply to this application. A <null> value is the only value which is accepted for this parameter. Other values for this parameter generate an error response using the error code "INUP".

### Normal Response Format:

No response is returned if a valid User session has not been established. Otherwise the response is in the following format.

cr lf lf

^^^<source identifier>^<date>^<time> cr lf

M^^<ctag>^COMPLD [ <rspblk>] cr lf ;

<rspblk>

This is the response block which may be repeated multiple times.

cr lf

^^^[<aid>][,<aidtype>]:<ntfncncde>,<condtype>,<srveff> , [<ocrdat>],[<ocrtm>],[<locn>],[<dirn>],[<tmper>]  
[:<conddescr>],[<aiddet>],[<obsdbhvr>[,<exptdbhvr>]] [:<dgntype>][,<tblast>]]]"

<aidtype>

This is the type of access identifier. Valid values for this application are:

EQPT        equipment

If the command code modifier is ALL, <aidtype> is required to specify the type of access identifier, else <aidtype> may be <null>.

<ntfncncde>

This is the notification code associated with a single alarm condition given in this block.

<condtype>

This is the condition type of the alarm condition being given in this block.

<srveff>

This is the effect on service caused by the single alarm condition given in this block.

<ocrdat>

This is the date when the triggering event occurred. The format for this parameter is MOY-DOM(Month-Of-Year - Day-Of-Month). MOY ranges from 1 to 12 and DOM ranges from 1 to 31.

A <null> value for this parameter defaults to the current date unless <ocrtm> is <null>, then this parameter does not apply.

<ocrtm>

This is the time when the triggering event occurred. The format for this parameter is HOD-MOH-SOM (Hour-Of-Day - Minute-Of-Hour - Second-Of-Minute). HOD ranges from 0 to 23. MOH and SOM range from 0 to 59.

A <null> value means this parameter and <ocrdat> are not applicable.

#### Unimplemented Parameters

The following two parameters do not apply to this application. A <null> value is inserted for them.

<locn> - location of alarm condition

<dirn> - direction of alarm condition

<tmper>

This is the accumulation time period for PM parameters. In this application, it represents the length of time the alarm condition has been active. The format for this parameter is "VAL-UN", where valid values for VAL (value) and UN (units) are given below.

<u>VAL</u>	<u>UNIT</u>
1	DAY (days) - used if alarm is active longer than 24 hours.
1 to 24	HR (hours)
1 to 1440	MIN (minutes) - used if alarm is active less than 24 hours.

<conddescr>

This parameter is a text message which provides a detailed description of the alarm, event, or condition. It is an ASCII string enclosed within a pair of escaped quotes("\"). It may also be used to describe any action to be taken as a result of the condition.

#### Unimplemented Parameters



**NOTE!** *The following parameters will either not be implemented or do not apply to this application. A <null> value is returned for these parameters.*

<aiddet> - supplementary equipment identification

<obsdbhvr> - observed behavior that resulted in reported trouble

<exptdbhvr> - expected behavior that was deviated from

<dgntype> - diagnostic routine used to isolate trouble

<tblast> - provides isolation information



## **RETRIEVE EQUIPMENT** **(RTRV-EQPT)**

**General Description:** This command message retrieves the software version of the specified equipment. For this application it retrieves the controller software version and the controller software configuration part number and revision.

**Controller Access Level:** any access level

### **Input Format:**

```
RTRV-EQPT:[<tid>]:<aid>:<ctag>;
```

<aid>

The AID parameter specifies the equipment whose information is to be retrieved. Valid values for the AID in this application are "SYSTEM" and "ALL". Both values will retrieve only the software version information for the power system controller.

### **Normal Response Format:**

cr lf lf

```
^^<source identifier>^<date>^<time> cr lf
```

```
M^^<ctag>^COMPLD cr lf
```

```
^^^<aid>:[<eqpt_type>]:[<cur_eqpt>]:[SWVER=<swver>],
```

```
[CURSWVER=<curswver>],[DSPSWVER=<dpswver>]:<state>,[<sst>]" crlf ;
```

<aid>

This is the type of access identifier of the equipment whose information is being provided. This value is always "SYSTEM" indicating that it is the system processor (i.e., controller).

<eqpt\_type>

This is the type of equipment installed. Valid values for this application is the controller part number.

<cur\_eqpt>

This is the type of equipment actually installed. Valid values for this application is <null>.

<swver>

Version of software that is configured. This is an ASCII string from one to thirty-two characters. The value of this parameter is the controller's software configuration part number and revision (e.g., "552365AB"). If no configuration part number is available, the value is <null>.

<curswver>

Version of software that is actually installed. This is an ASCII string from one to thirty-two characters. The value of this parameter is the controller's software version (e.g., "1.30"). If no software version is available, the value is <null>.

<dpswver>

Version of DSP code on the device. This parameter does not apply to this application. A value of <null> is always outputted for this parameter.

<state>

This is the operational state of the equipment. Valid values are: IS-NR (In Service – Normal), OOS-AUMA (Out Of Service – Autonomous and Management). A value of IS-NR” should always be returned because a response to the command indicates that the controller is operational.

<sst>

This is the secondary state of the equipment. This parameter is not available in this application. A value of <null> is always outputted for this parameter.

## **RETRIEVE-HEADER** **(RTRV-HDR)**

**Referenced In:** TR-NWT-000833, Issue 5; pg. 4-283

**General Description:** Requests that the NE (controller) reply with a "normal" response indicating COMPLD. The information of interest in the reply is the reply itself along with information that the NE (controller) has about itself, namely the <source identifier>, the <date>, and the <time>.

This command can be used to verify the access to a specific NE (controller).

**Controller Access Level:** any access level

### **Input Format:**

RTRV-HDR:[<tid>]:<aid><ctag>;

<aid>

The <aid> in this command must be <null> since it does not apply.

### **Normal Response Format:**

cr lf lf

^^<source identifier>^<date>^<time> cr lf

M^^<ctag>^COMPLD cr lf

## 7.4.5 TL1 Autonomous Messages Supported (in alphabetical order)

This section lists the specific autonomous messages (in alphabetical order) the controller supports. A brief description of each is provided.



**NOTE!** *In autonomous messages, the fractional portion of the ATAG is not supported.*

### **CANCEL SESSION (TIMEOUT)**

**Referenced In:** TR-TSY-000835, Issue 2; pg. 12.5-13

**General Description:** This is an automatic message transmitted by the NE (controller) when an established session is terminated because of a "timeout", i.e., no messages were exchanged for an interval equal the controller session timeout setting.

#### **Message Format:**

```
cr lf lf  
^^<sid>^<YY-MM-DD>^<HH:MM:SS> cr lf  
A^^<atag>^CANC cr lf  
<uid> cr lf ;  
  
<uid>
```

This is the User whose session is terminated as a result of the timeout.

## **REPORT ALARM (REPT ALM {EQPT/COM})**

**Referenced In:** TR-NWT-000833, Issue 5; pg. 5-5

**General Description:** Generated by an NE (controller) to report the occurrence of alarmed events. Trouble events occurring in the NE (controller) are classified as alarmed or non-alarmed events.

### **Message Format:**

```
cr lf lf
^^<source identifier>^<date>^<time> cr lf
<almcde>^<atag>^REPT^ALM^EQPT
cr lf <rspblk> cr lf;
```



**NOTE!** The only second message modifier supported for this controller application is 'EQPT'. Other message modifiers allowed by the TL1 protocol standards are not supported.

<rspblk>

This is the response block which may be repeated multiple times.

```
^^"<aid>:<ntfncde>,<condtype>,<srveff>, [<ocrdat>],[<ocrtm>],[<locn>],[<dirn>], [<monval>],[<thlev>],[<tmper>]
[<conddescr>],[<aiddet>],[<obsdbhvr>],[<exptdbhvr>]] [[:<dgntype>],[<tblist>]]]"
```

In this application each individual response block specifies only one alarm. Use of multiple values for parameters (referred to as parameter grouping) in the response block is not supported.

<aid>

Identifies the single entity in the NE (controller) to which the alarm pertains.

<ntfncde>

This is the notification code associated with a single alarm condition given in this block. Valid values are as follows:

CR	Critical alarm
MJ	Major alarm
MN	Minor alarm
CL	Cleared alarm

For this application, values are derived from the *notification code* configuration parameter of the controller configuration with which the alarm condition is associated. The exception to this is the CL code which is used when reporting an alarm has cleared.

<condtype>

This is the condition type of the alarm. It indicates the type of failure that has occurred/cleared.

<srveff>

This is the effect on service caused by the single alarm condition given in this block. Valid values are as follows:

SA	Service-affecting condition immediate action required.
NSA	Nonservice-affecting condition, action required.

<ocrdat>

This is the date when the triggering event occurred (i.e., the threshold was crossed). The format for <ocrdat> is MOY-DOM. MOY ranges from 1 to 12 and DOM ranges from 1 to 31. A <null> value for this parameter defaults to the date in the message header.

<ocrtm>

This is the time when the event occurred. The format for <ocrtm> is HOD-MOH-SOM. HOD ranges from 0 to 23. MOH and SOM range from 0 to 59. A <null> value for this parameter defaults to the time in the message header.



**NOTE!** *The following two parameters do not apply to this application. A <null> value is inserted for them.*

<locn> - location of alarm condition

<dirn> - direction of alarm condition

<monval>

This is the measured value of the monitored value associated with the alarm condition. A <null> value is inserted if there is no measured value associated with this trouble.

<thlev>

This is the value of the threshold level if the <condtype> is a threshold violation. A <null> value means there is no threshold level associated with the alarm condition.

<tmper>

This is the accumulation time period for PM parameters. In this application it represents the length of time the alarm condition has been active. The format for this parameter is "VAL-UN", where valid values for VAL (value) and UN (units) are given below.

<u>VAL</u>	<u>UNIT</u>
1	DAY (days) - used if alarm is active longer than 24 hours.
1 to 24	HR (hours)
1 to 1440	MIN (minutes) - used if alarm is active less than 24 hours.

<conddescr>

This parameter is a text message which provides a detailed description of the alarm, event, or condition. It is an ASCII string enclosed within a pair of escaped quotes (\"). It may also be used to describe any action to be taken as a result of the condition. For this application, values are derived from the *condition description* configuration parameter of the controller configuration with which the alarm condition is associated. If the parameter has not been configured, a <null> is inserted for this parameter.

#### Unimplemented Parameters



**NOTE!** *The following parameters are either not implemented or do not apply to this application. A <null> value is inserted for them.*

<aiddet> - supplementary equipment identification

<obsdbhvr> - observed behavior that resulted in reported trouble

- <exptdbhvr> - expected behavior that was deviated from
- <dgntype> - diagnostic routine used to isolate trouble
- <tblast> - provides isolation information

## 7.4.6 List of Error Codes for TL1 Commands Supported (in alphabetical order)

This section provides a list of error codes for the TL1 commands supported.

ENEQ - Equipage, Not Equipped  
ENRI - Equipage, Not equipped for Retrieving specified Information  
ENSI - Equipage, Not equipped for Setting specified Information  
ICNV - Input, Command Not Valid  
IDNV - Input, Data Not Valid  
IIAC - Input, Invalid Access Identifier  
IICT - Input, Invalid Correlation Tag  
IIFM - Input, Invalid Data Format  
IIPG - Input, Invalid Parameter Grouping  
IISP - Input, Invalid Syntax or Punctuation  
IITA - Input, Invalid Target identifier  
INUP - Input, Non-null Unimplemented Parameter  
IORD - Input, Out of Range Data  
PICC - Privilege, Illegal Command Code  
PIFC - Privilege, Illegal Field Code  
PIUC - Privilege, Illegal User Code  
PIUI - Privilege, Illegal User Identity  
SARB - Status, All Resources Busy  
SCNF - Status, Command Not Found  
SDNR - Status, Data Not Ready  
SROF - Status, Requested Operation Failed



## 8 Inverter Only System

### 8.1 General

When the controller is used in an inverter only system (Only inverters are installed in the system), the Web pages are different than those previous described. Refer to this section for Web page descriptions for an inverter only system.

### 8.2 Web Interface Screens

#### 8.2.1 Overview of Web Function

This section provides descriptions of the Web Interface Screens. Refer also to “Passwords and Privilege Levels” on page 19 and “Using the Web Interface” on page 20.



**NOTE!** Best viewed at 1024 x 768 resolution.

#### 8.2.2 Homepage

In the Web Interface, after entering a valid **Username** and **Password** and clicking **LOGIN**, the "Homepage" window opens. See also “Logging into the Controller” on page 21.

Figure 8.1 Controller Homepage



6. System Status Area

The homepage window is divided into the following areas:

1. System Status Information Area (see “System Status Information Area” on page 252).
2. System Specifications Information Area (see “System Specifications Information Area” on page 252).
3. Controller Specifications Information Area (see “Controller Specifications Information Area” on page 252).

4. Site Information Area (see “Site Information Area” on page 252).
5. Alarms Area (see “Alarms Area” on page 253).
6. System Status Area (see “System Status Area” on page 253).
7. Menu Navigation Area (see “Menu Navigation Area” on page 259).

### 8.2.3 System Status Information Area

Output voltage and output current is displayed here.

### 8.2.4 System Specifications Information Area

System specifications are displayed here.

### 8.2.5 Controller Specifications Information Area

Controller specifications are displayed here.

### 8.2.6 Site Information Area

Site information is displayed here.

**Figure 8.2 System Status Information, System Specifications Information, Controller Specifications Information, and Site Information Areas**

System Status	
Inverter Voltage	120.2V
Inverter Current	3.6A
System Specifications	
System Name	Lorain
Inverters	3
Controller Specifications	
Product Model	M830D
Serial Number	03190307690
Hardware Version	A16
Software Version	1.2.45P03
Config Version	InvOnly
Site Information	
Site Name	ESNA
Site Location	Lorain

## 8.2.7 Alarms Area

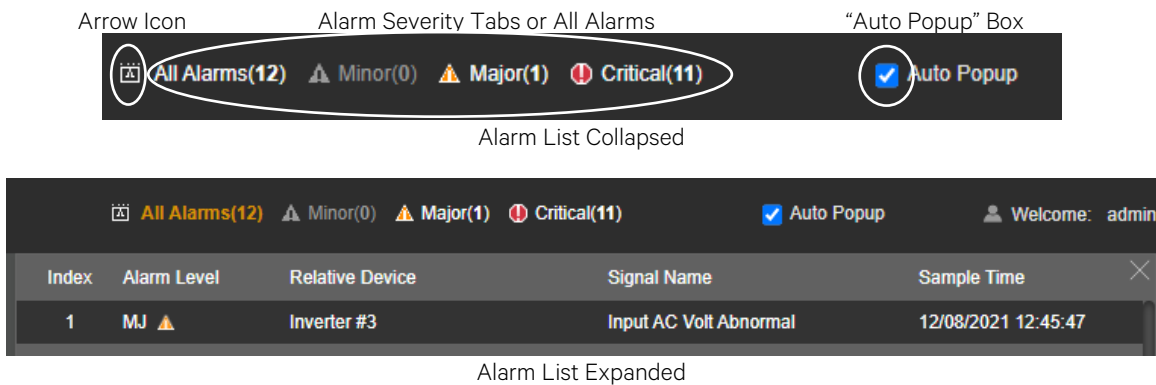
Any alarms active in the power system are shown in this area.

- When viewing the Alarm List, click the “arrow” icon to collapse the Alarm List. Click the “arrow” icon again to expand the Alarm List.
- The alarms area contains tabs to allow viewing all alarms or a type of alarm (severity). For example, click the Critical tab to display alarms set as Critical alarms.
- When the “Auto Popup” box is checked and the Alarm List is collapsed, a new alarm will cause the Alarm List to expand.



**NOTE!** Minor alarms are shaded yellow, major alarms are shaded orange, and critical alarms are shaded red.

Figure 8.3 Alarms Area



## 8.2.8 System Status Area

### General

System status is displayed in this area and consists of a Power System status tab (see page 253) and a General Status tab (see page 258).

### Power System Status Tab

The Power System status tab displays power system status in a graphical block diagram format. This includes status of the input power, inverters, and AC load. Also displayed are alarm status, ambient temperature, output power, average power, and a load trend chart.

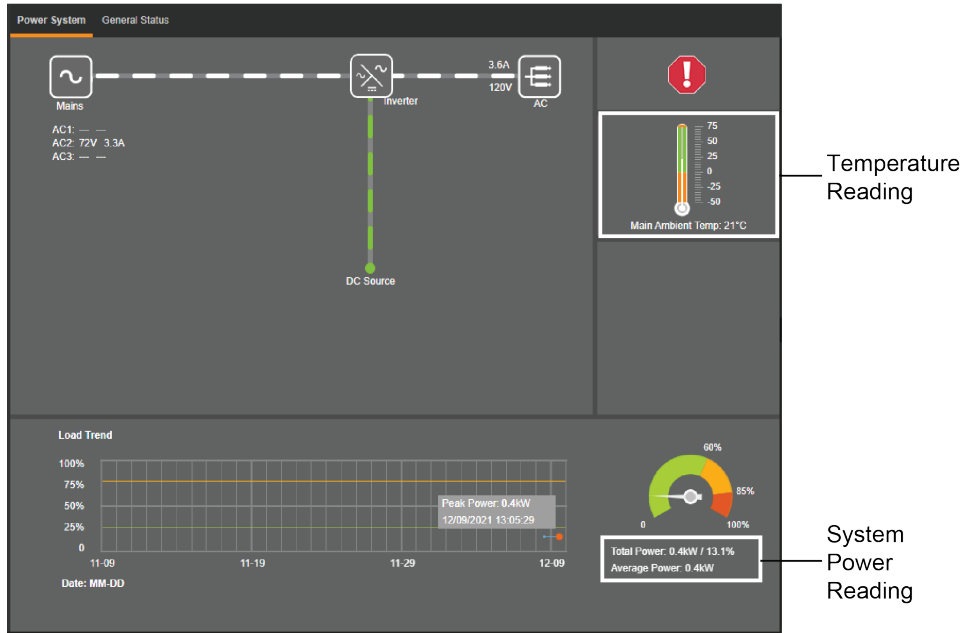
### Temperature Reading

- The temperature sensor set as “Main Ambient Temp Sensor” (Settings Menu / System Tab) is the sensor which displays the ambient temperature on the Power System status tab.



**NOTE!** The load trend chart gets data from the “Data History Log” and will plot the MAXIMUM value per hour per day.

Figure 8.4 Power System Status Tab

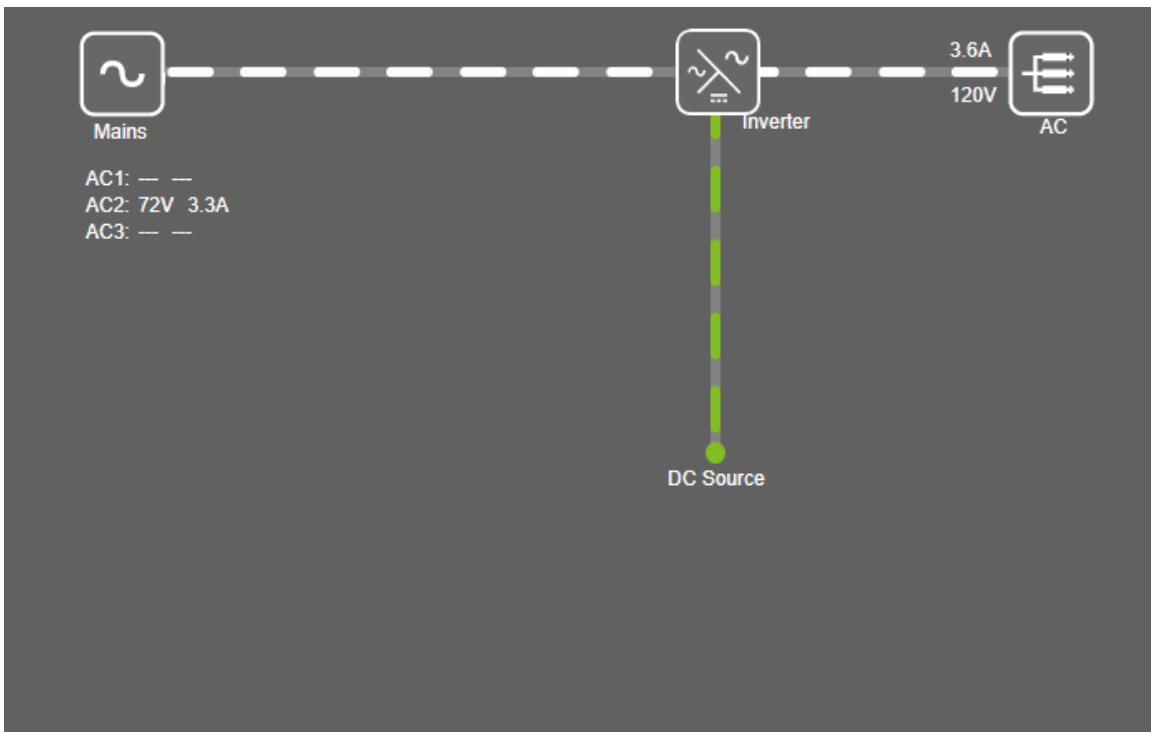


**Power System Status Graphical Block Diagram**

**General**

The power system status block diagram has User interactive links. Clicking on the various icons will take you to that device’s status Web page. A device status page displays current or logged operating parameters for that device.

Figure 8.5 Power System Status Page Block Diagram



### **Inverter AC Mains Status Web Page**

Clicking on the inverter Mains icon on the power system status block diagram opens the inverter AC mains status web page.

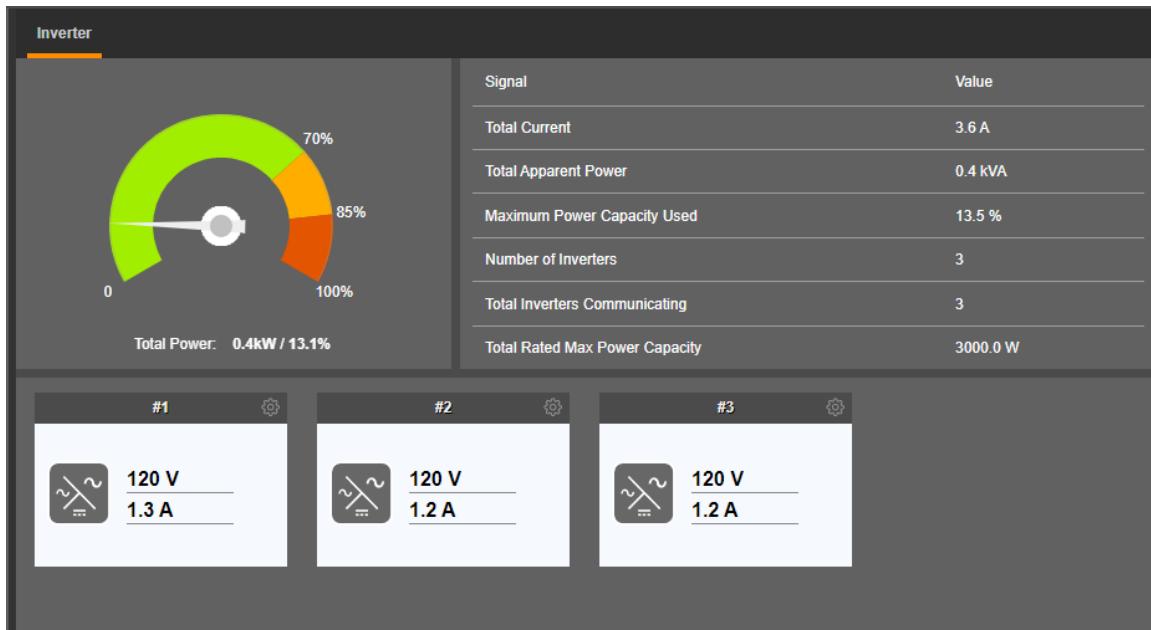
**Figure 8.6 Inverter AC Mains Status Web Page**

	AC1	AC2	AC3
Voltage (VAC)	—	72	—
Current (A)	—	3.3	—

### **Inverter Module Status Web Page**

Clicking on the Inverter icon on the power system status block diagram opens the inverter module status web page.

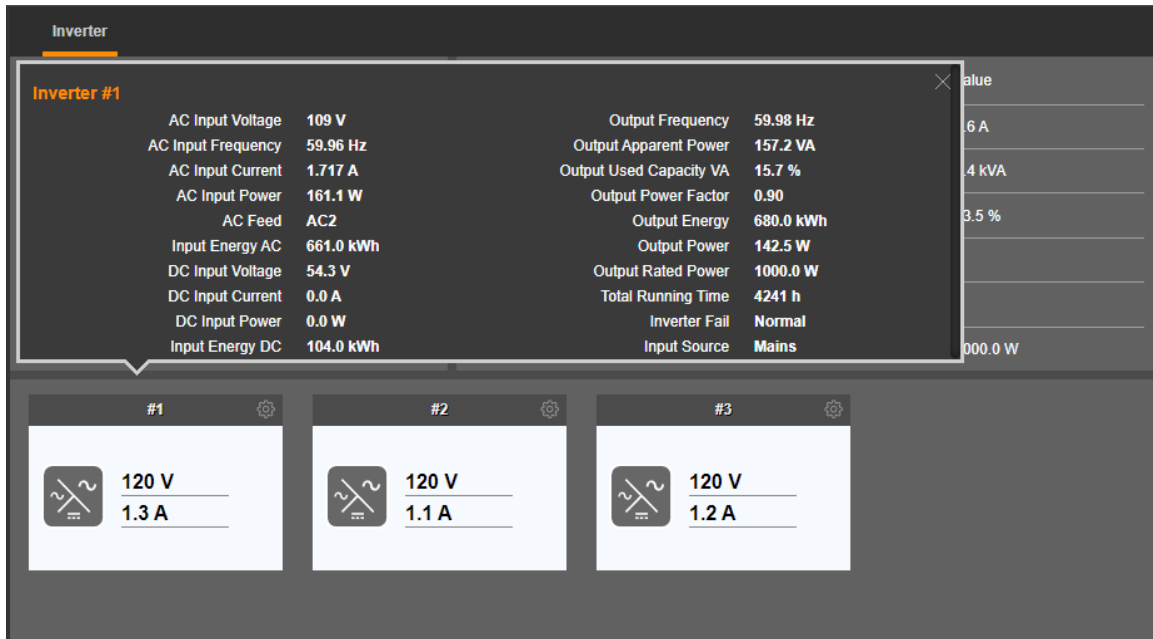
**Figure 8.7 Inverter Module Status Web Page**



#### Individual Inverter Module Status

Displayed on the inverter module status web page are the individual inverters installed in the system. Click on an individual inverter icon to display its status such as "Output Power", etc.

Figure 8.8 Individual Inverter Module Status



Individual Inverter Module Settings Page


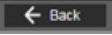
On the inverter module status web page, click the settings wheel icon  to go to the individual inverter module settings page. Click  to go back to the inverter module status web page.

Figure 8.9 Selecting an Individual Inverter Module Settings Page

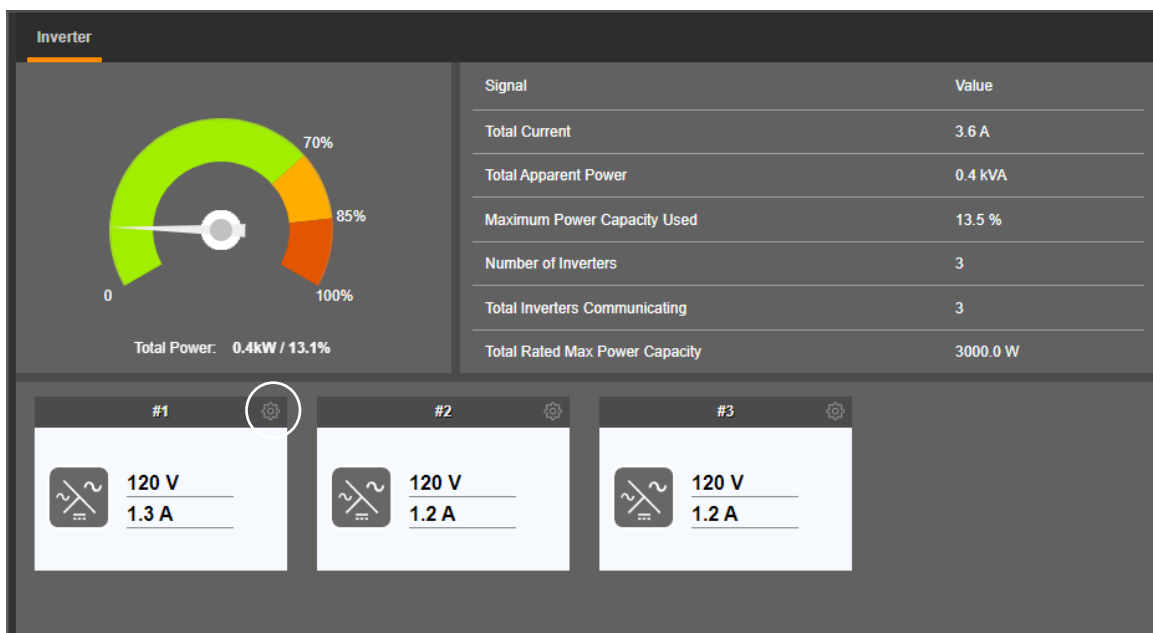


Figure 8.10 Individual Inverter Module Settings Page

Inverter				
#1 Inverter Settings <span style="float: right;">← Back</span>				
Signal	Value	Time Last Set	Set Value	Set
LED Control	Cancel	–	<input checked="" type="radio"/> Cancel <input type="radio"/> Flashing	Set
Inverter ID	1	12/06/2021 12:04:25	<input type="text"/> 1~36	Set
AC Feed	AC2	–	<input type="text"/> AC1	Set



**NOTE!** Settings that appear "grayed out" can only be made when the controller is in the "manual control" state. If the controller is set for "automatic" control, change the "Auto/Manual State" setting first to the "Manual" setting.

- **LED Control:** Temporarily sets whether or not an inverter's local power indicator blinks when the controller is communicating with the inverter when the controller is in Manual mode. Setting returns to original when controller is returned to the Auto mode.
- **Inverter ID:** Sets the inverter's identification number.
- **AC Feed:** Indicates the phase connected to the inverter's input.

### **AC Load Status Page**

Clicking on the AC icon on the power system status block diagram opens the AC load status page.

Figure 8.11 AC Load Status Page

AC			
AC Distribution			
Signal	Value	Signal	Value
Current (A)	3.7	Voltage (VAC)	120
Power (kW)	0.4	Output Energy (kWh)	1971.0
Power (kVA)	0.4		

## General Status Tab

The General Status tab displays general status information as shown in the following illustration.



**NOTE!** Temperature items are displayed only if temperature probes are connected.

Figure 8.12 General Status Tab

Power System		General Status	
User Define			
Signal	Value	Signal	Value
NCU DI1	Low	NCU DI2	Low
NCU DI3	Low	NCU DI4	Low
IB2-1 DI1	Low	IB2-1 DI2	Low
IB2-1 DI3	Low	IB2-1 DI4	Low
IB2-1 DI5	Low	IB2-1 DI6	Low
IB2-1 DI7	Low	IB2-1 DI8 ESTOP	Low
Main Ambient Temperature	21 deg.C	IB2-1 Temp1 (amb)	21.3 deg.C
SMTemp1 T1 (amb)	21.2 deg.C	SMTemp1 T2 (amb)	-273.0 deg.C
Temp Comp Temperature	20 deg.C	IB2-1 Temp2 (bat)	20.5 deg.C
SMTemp1 T3 (bat)	-273.0 deg.C		



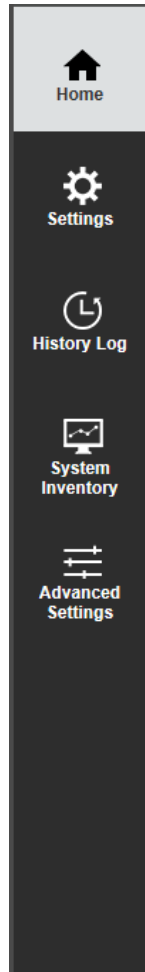
## 8.2.9 Menu Navigation Area

### General

Available menus are displayed in this area. When a menu is clicked on, the system status screen is replaced with the selected menu's screen. Note that there is a menu item named HOME to return to the system status screen.

Located at the top of each of the main menus are tabs to select the various sub-menus. If there are more sub-menus then can be displayed in the window, an arrow appears to navigate to the additional sub-menus.

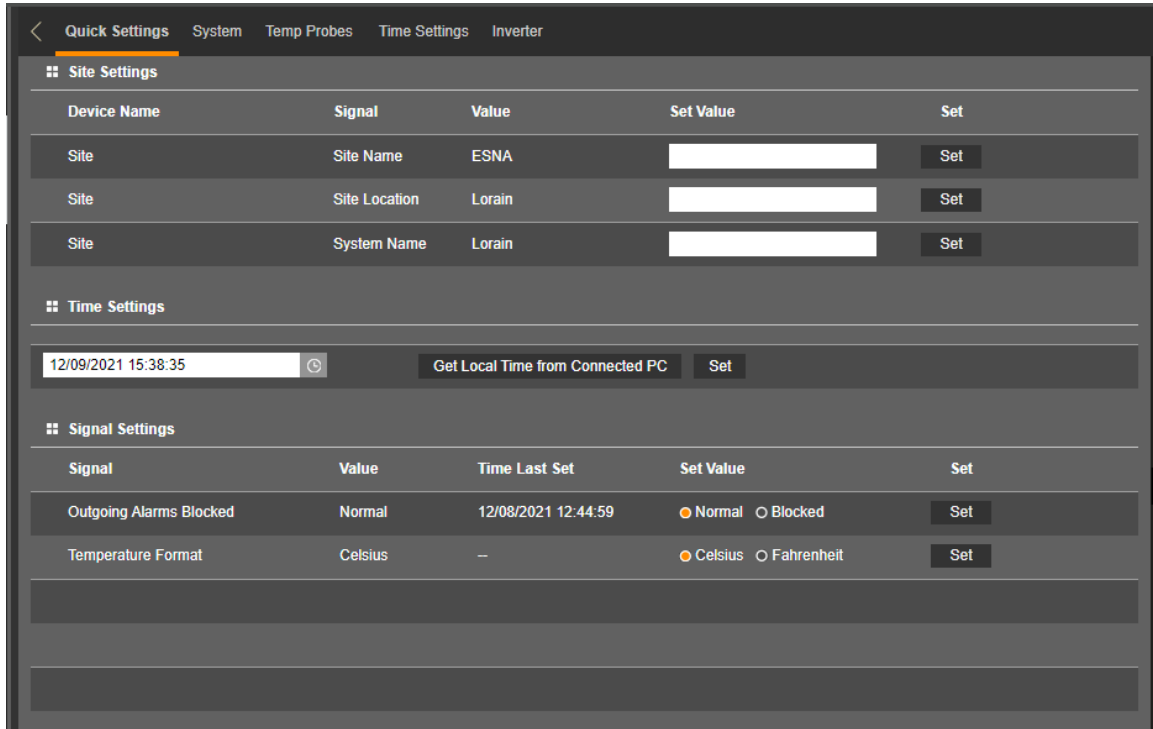
Figure 8.13 Menu Navigation Area



### Settings Menu

The Settings Menu allows you to change (if you have the proper privilege level programmed in your User settings) the settings of the various programmable parameters. Settings are grouped per function. Select a tab in the Settings Menu to change that function's programmable parameters.

Figure 8.14 Settings Menu



### Changing Programmable Parameters in the Settings Menu

To change a programmable parameter, select or enter a new value for the parameter then click on “Set” to change the value.



**NOTE!** Settings that appear “grayed out” can only be made when the controller is in the “manual control” state. If the controller is set for “automatic” control, change the “Auto/Manual State” setting first to the “Manual” setting.

### Quick Settings Tab Programmable Parameter Descriptions

- **Site Settings:** Enter a “Site Name”, “Site Location”, and “System Name”.
- **Time Settings:** Enter the time or select “Get Local Time from Connected PC”.

In the Time Settings section, click on “Get Local Time from Connected PC” and then “Set” to automatically set the date and time. To manually set the date and time, click on “the clock symbol” and enter the date and time. Then select the “Confirm” button. See Figure 8.15. In the Time Settings section, click on “Set” to save the change.

- **Signal Settings:**
  - **Outgoing Alarms Blocked:**
    - Normal:** Alarms are processed normally.
    - Blocked:** Forces the alarm relays in the “off” state and blocks alarms from changing the relay state.
  - **Temperature Format:** Sets the temperature display. The choices are Celsius or Fahrenheit.

Figure 8.15 Manual Date and Time Menu

Value	Time Last Set	Set Value	Set
Normal	12/08/2021 12:44:59	<input checked="" type="radio"/> Normal <input type="radio"/> Blocked	Set
Celsius	—	<input checked="" type="radio"/> Celsius <input type="radio"/> Fahrenheit	Set

### System Tab Programmable Parameter Descriptions

- **Relay Test:** Sets the Relay Test feature to Automatic, Manual, or Disabled. Refer to “Using the Relay Test Feature” on page 40.
- **Relay Test Time:** Sets the Relay Test Time for the Automatic Relay Test feature.
- **Main Ambient Temp Sensor:** Sets the temperature sensor which displays the ambient temperature on the Web Interface's Homepage. Note that this temperature sensor MUST be set as an ambient temperature sensor. Select "None", or the temperature probe [System Temp1, System Temp2, System Temp3, IB2-1 Temp1, IB2-1 Temp2, EIB-1 Temp1, EIB-1 Temp2, SMTemp1 Temp1, ..., SMTemp1 Temp8, ..., SMTemp8 Temp1, ..., SMTemp8 Temp8]. You can also select Maximum or Average which takes the maximum or average reading of the temperature probes [any of System Temp1, System Temp2, System Temp3, IB2-1 Temp1, IB2-1 Temp2, EIB-1 Temp1, EIB-1 Temp2, SMTemp1 Temp1, ..., SMTemp1 Temp8, ..., SMTemp8 Temp1, ..., SMTemp8 Temp8] set as ambient temperature probes. When set, the following parameters can also be set.
  - Main Ambient Temp High2:** Sets the Main Ambient Temperature High 2 alarm point.
  - Main Ambient Temp High1:** Sets the Main Ambient Temperature High 1 alarm point.
  - Main Ambient Temp Low:** Sets the Main Ambient Temperature Low alarm point.
- **Fail Safe Mode:** When enabled, sets the relay designated as the "Critical Summary" alarm relay to operate in the "fail safe" mode. In this mode, the relay is energized during normal operation and de-energized for an alarm condition.
- **Outgoing Alarms Blocked:**
  - **Normal:** Alarms are processed normally.
  - **Blocked:** Forces the alarm relays in the "off" state and blocks alarms from changing the relay state.

- **EStop / EShutdown**
  - **Disabled:** Disables the Emergency Stop and Emergency Shutdown functions.
  - **EStop:** Enables the Emergency Stop function. (If utilized in the system, an Estop signal shuts down and locks out the system. The system must be manually restarted. Refer to the system instruction manual for restarting procedure.)
  - **EShutdown:** Enables the Emergency Shutdown function. (If utilized in the system, an EShutdown signal shuts down the system. The system automatically restarts when the signal is removed.)
- **Audible Alarm**
  - **Off:** Disables the audible alarm.
  - **On:** When a new alarm occurs, the audible alarm sounds. Press any key to silence the audible alarm.
  - **3 min / 10 min / 1 hr / 4 hrs:** When a new alarm occurs, the audible alarm sounds. The audible alarm automatically silences after the selected time period.
- **Auto/Manual State:**
  - **Auto:** The controller automatically controls the power system.
  - **Manual:** A User can manually change certain power system control settings. When you return to Auto Mode, any settings changed in Manual Mode are returned to their previous setting (setting before being placed in Manual Mode). This provides a convenient means of making temporary adjustment changes for testing purposes.
- **Manual Mode Time Limit:** Time delay before returning to automatic control after being set for manual control. A "0" setting disables the "Manual Mode Time Limit" feature and the controller MUST be manually set to Auto control after being set to Manual control.
- **LCD Rotation:** Sets the rotation of the text in the menus (allowing the controller to be mounted in different orientations).
  - **0 deg:** Display will be in the horizontal position (M830B only).
  - **90 deg:** Display will be in the vertical position (controller mounted 90 deg clockwise) (M830B only).
  - **Big Screen:** Setting for M830D only.
- **Time Display Format:** Sets the format of the date. The choices are DD/MM/YYYY, MM/DD/YYYY, or YYYY/MM/DD.
- **Temperature Format:** Sets the temperature display. The choices are Celsius or Fahrenheit.
- **System Alarm Function:** Sets what types of alarms the BAY alarm LED will light (if the system provides a Bay Alarm led). The choices are: "CR Only", "CR and MJ", and "CR, MJ and MN".

#### **Temp Probes Tab Programmable Parameter Descriptions**

- **IB2-1 Temp 1:** Sets temperature port 1 on the IB2-1 board to None or Ambient. When set, the following parameters can also be set.
  - IB2-1 Temp1 High 2:** Sets temperature port 1 on the IB2-1 board "Temperature High 2" alarm point.
  - IB2-1 Temp1 High 1:** Sets temperature port 1 on the IB2-1 board "Temperature High 1" alarm point.
  - IB2-1 Temp1 Low:** Sets temperature port 1 on the IB2-1 board "Temperature Low" alarm point.
- **IB2-1 Temp 2:** Sets temperature port 2 on the IB2-1 board to None or Ambient. When set, the following parameters can also be set.
  - IB2-1 Temp2 High 2:** Sets temperature port 2 on the IB2-1 board "Temperature High 2" alarm point.
  - IB2-1 Temp2 High 1:** Sets temperature port 2 on the IB2-1 board "Temperature High 1" alarm point.

**IB2-1 Temp2 Low:** Sets temperature port 2 on the IB2-1 board “Temperature Low” alarm point.

- **EIB-1 Temp 1:** Sets temperature port 1 on the EIB-1 board to None or Ambient. When set, the following parameters can also be set.

**EIB-1 Temp1 High 2:** Sets temperature port 1 on the EIB-1 board “Temperature High 2” alarm point.

**EIB-1 Temp1 High 1:** Sets temperature port 1 on the EIB-1 board “Temperature High 1” alarm point.

**EIB-1 Temp1 Low:** Sets temperature port 1 on the EIB-1 board “Temperature Low” alarm point.

- **EIB-1 Temp 2:** Sets temperature port 2 on the EIB-1 board to None or Ambient. When set, the following parameters can also be set.

**EIB-1 Temp2 High 2:** Sets temperature port 2 on the EIB-1 board “Temperature High 2” alarm point.

**EIB-1 Temp2 High 1:** Sets temperature port 2 on the EIB-1 board “Temperature High 1” alarm point.

**EIB-1 Temp2 Low:** Sets temperature port 2 on the EIB-1 board “Temperature Low” alarm point.

- **SMTemp# Temp #:** Sets temperature port # on the SM-Temp # module to None or Ambient. When set, the following parameters can also be set.

**SMTemp# Temp# High 2:** Sets temperature port # on the SM-Temp # module “Temperature High 2” alarm point.

**SMTemp# Temp# High 1:** Sets temperature port # on the SM-Temp # module “Temperature High 1” alarm point.

**SMTemp# Temp# Low:** Sets temperature port # on the SM-Temp # module “Temperature Low” alarm point.

- **Clear SM Temp Lost Alarm:** Clears an SM Temp lost alarm. The only selection is Clear. Once Clear is selected and confirmed, the alarm clears.
- **SMTEMP# Clear Probe Alarm:** Clears an SM Temp Probe Fail alarm. The only selection is Clear. Once Clear is selected and confirmed, the alarm clears.

### **Time Settings Tab Programmable Parameter Descriptions**

See also “Changing the Date and Time” on page 27.

- **Specify Time**
  - **Get Local Time from Connected PC:** Allows you to automatically set the time. When selected, the controller will get the same time as the connected PC.
  - **Date & Time:** Allows you to manually set the date and time.
- **Local Zone (for synchronization with time servers):** When selected, the controller will get the local zone automatically or you can enter the zone.
- **Get time automatically from the following servers.**
  - When selected, the controller will get the time from the selected time server. The controller will also adjust the time per the “Local Zone” setting.

### **Inverters Tab Programmable Parameter Descriptions**

- **DC Low Voltage Off:** Low output voltage threshold the inverter will turn off.
- **DC Low Voltage On:** Low output voltage threshold the inverter will turn on.
- **DC High Voltage Off:** High output voltage threshold the inverter will turn off.

- **DC High Voltage On:** High output voltage threshold the inverter will turn on.
- **Primary Input Power:** Sets the input mode of operation (AC Mode, DC Mode, DC Only).
- **Output On/Off Control:** Turns output On/Off to all inverters to check/set the “Output Voltage Level” and “Output Frequency”.
- **LED Control:** Temporarily sets whether or not an inverter’s local power indicator blinks when the controller is communicating with the inverter when the controller is in Manual mode. Setting returns to original when controller is returned to the Auto mode.
- **Fan Speed Control:** Sets the fan speed for all inverters.
- **Confirm Inverter ID/Feed:** After changing inverter ID and/or input feed assignments, use this menu item to confirm the change. The only selection is Yes. Once Yes is selected and confirmed, the ID and feed setting of all inverters are updated.
- **Reset Inverter IDs:** Resets the inverter IDs after they have been previously changed and confirmed. The only selection is Yes. Once Yes is selected and confirmed, the controller resets the inverter IDs by reassigning ID numbers.
- **Clear Inverter Lost Alarm:** Clears an inverter lost alarm. The only selection is Yes. Once Yes is selected and confirmed, the alarm clears.
- **Clear Inverter Comm Fail Alarm:** Clears an inverter communication fail alarm. The only selection is Yes. Once Yes is selected and confirmed, the alarm clears.
- **Clear All Invt Comm Fail Alarm:** Clears all inverter communication fail alarms. The only selection is Yes. Once Yes is selected and confirmed, all alarms clear.
- **Clear Fault:** Clears an inverter fault alarm. The only selection is Yes. Once Yes is selected and confirmed, the alarm clears.
- **Inverter Upgrade:** Enables or disables upgrading the firmware in the inverters.
- **Normal Update:** When “Yes” is selected, updates the inverters’ firmware. See “Upgrading the Inverters Firmware” on page 45.

## History Log Menu

The History Log Menu allows you to view and save the various logs available in the controller.

### Alarm History Log Tab

#### Select Device and Time

Select the "Device" to query from the drop-down list box. Select the "from" and "to" time.

Figure 8.16 Alarm History Log Device and Time Selection

The screenshot shows the 'Alarm History Log' tab selected. The 'Device' dropdown is set to 'All Devices'. The 'From' time is '12/09/2021 09:59:04' and the 'To' time is '12/10/2021 09:59:04'. A 'Query' button is visible. Below the time selection, there is a calendar for December 2021 and a time selection grid with 'Hour' (9), 'Minute' (59), and 'Second' (4) dropdowns. 'Confirm' and 'Current Time' buttons are at the bottom.

#### Query Alarm History Log

Click "Query" to query for alarms within selected time slot. The Web page displays the last 500 entries.

Figure 8.17 Alarm History Log Query

The screenshot shows the 'Alarm History Log' tab with 'Device' set to 'Power System'. The 'From' time is '05/02/2021 09:59:04' and the 'To' time is '12/10/2021 09:59:04'. 'Query' and 'Upload' buttons are visible. Below the time selection, it says 'Displays the last 500 entries!'. A table displays the following data:

Index	Device Name	Signal Name	Alarm Level	Start Time	End Time
1	Power System	Main Ambient Sensor Fail	MJ	12/10/2021 09:05:51	12/10/2021 09:05:58
2	Power System	Main Ambient Sensor Fail	MJ	12/10/2021 09:05:10	12/10/2021 09:05:16
3	Power System	Manual State	MN	12/10/2021 08:46:34	12/10/2021 08:47:14
4	Power System	Main Ambient Sensor Fail	MJ	12/09/2021 16:00:51	12/09/2021 16:01:59

Upload Alarm History Log

Click “Upload” to open the log into another window. You can then save the log as an .html (Web page) or .txt (text) file.

**Figure 8.18 Alarm History Log Upload**

Query Alarm History Log  
 Query EquipID: Power System  
 Query Time: from 05-02-2021 08:59:04 to 12-10-2021 09:59:04  
 Total 4 alarm(s) queried.

Index	Device Name	Signal Name	Alarm Level	Start Time	End Time
1	Power System	Main Ambient Sensor Fail	MA	12-10-2021 09:05:51	12-10-2021 09:05:58
2	Power System	Main Ambient Sensor Fail	MA	12-10-2021 09:05:10	12-10-2021 09:05:16
3	Power System	Manual State	OA	12-10-2021 08:46:34	12-10-2021 08:47:14
4	Power System	Main Ambient Sensor Fail	MA	12-09-2021 16:00:51	12-09-2021 16:01:59

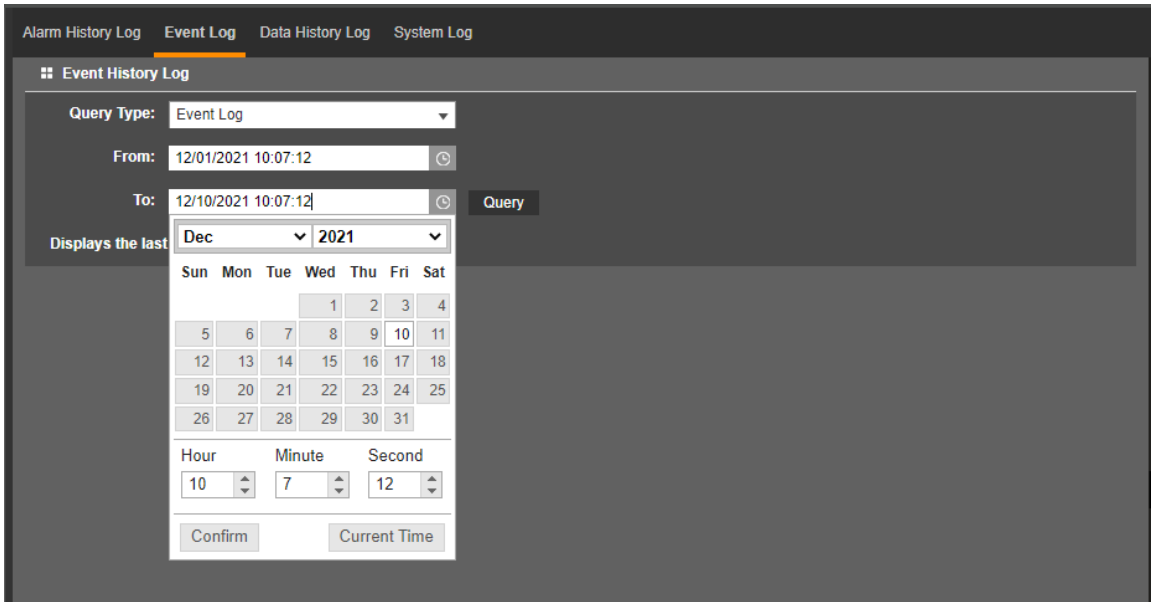


### Event Log Tab

#### Select Time

Select the "from" and "to" time.

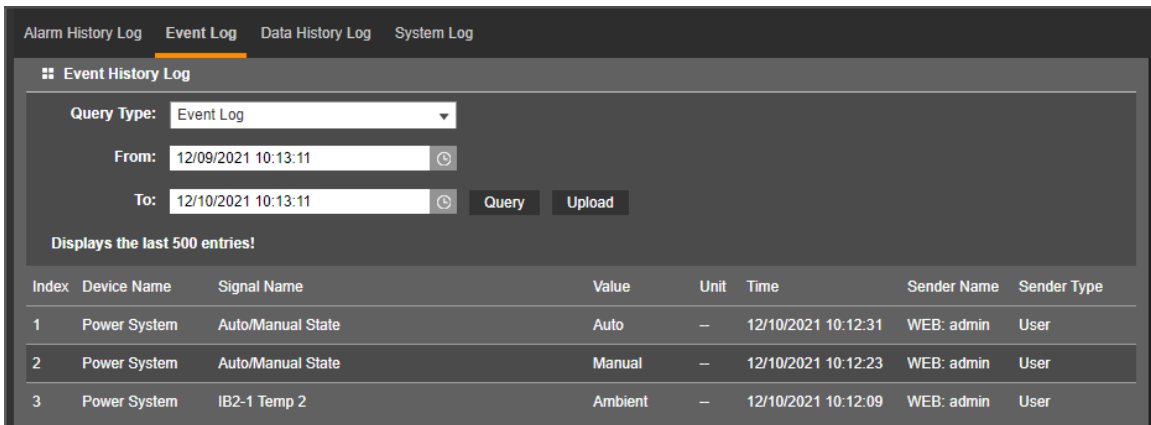
Figure 8.19 Event Log Time Selection



#### Query Event Log

Click "Query" to query the Event Log. The Web page displays the last 500 entries.

Figure 8.20 Event Log Query



Upload Event Log

Click “Upload” to open the log into another window. You can then save the log as an .html (Web page) or .txt (text) file.

**Figure 8.21 Event Log Upload**

Query Event Log

Query Time: from 12-09-2021 10:13:11 to 12-10-2021 10:13:11

Total 3 record(s) queried.

Index	Device Name	Signal Name	Value	Unit	Time	Sender Name	Sender Type
1	Power System	Auto/Manual State	Auto	--	12-10-2021 10:12:31	WEB: admin	User
2	Power System	Auto/Manual State	Manual	--	12-10-2021 10:12:23	WEB: admin	User
3	Power System	IB2-1 Temp 2	Ambient	--	12-10-2021 10:12:09	WEB: admin	User

### Data History Log Tab

Select Device and Time

Select the "Device" to query from the drop-down list box. Select the "from" and "to" time.

Figure 8.22 Data History Log Device and Time

Alarm History Log Event Log **Data History Log** System Log

☰ Data History Log

Device: All Devices

From: 12/09/2021 10:22:08

To: 12/10/2021 10:22:08 Query

Displays the last

Dec 2021

Sun	Mon	Tue	Wed	Thu	Fri	Sat
			1	2	3	4
5	6	7	8	9	10	11
12	13	14	15	16	17	18
19	20	21	22	23	24	25
26	27	28	29	30	31	

Hour: 10 Minute: 22 Second: 8

Confirm Current Time

Query Data History Log

Click "Query" to query for Date History within selected time slot. The Web page displays the last 500 entries.

Figure 8.23 Data History Log Query

Alarm History Log Event Log **Data History Log** System Log

☰ Data History Log

Device: All Devices

From: 12/09/2021 10:22:08

To: 12/10/2021 10:22:08 Query Upload

Displays the last 500 entries!

Index	Device Name	Signal Name	Value	Unit	Time
1	Inverter Group	Total Current	3.61	A	12/10/2021 10:21:07
2	Inverter Group	Total Output Power	0.39	kW	12/10/2021 10:21:07
3	Inverter Group	Total Current	3.64	A	12/10/2021 10:16:04
4	Inverter Group	Total Output Power	0.39	kW	12/10/2021 10:16:04

Upload Data History Log

Click “Upload” to open the log into another window. You can then save the log as an .html (Web page) or .txt (text) file.

**Figure 8.24 Data History Log Upload**

Query Data History Log

Query EquipID: All Devices

Query Time: from 12-09-2021 10:22:08 to 12-10-2021 10:22:08

Total 2648 record(s) queried.

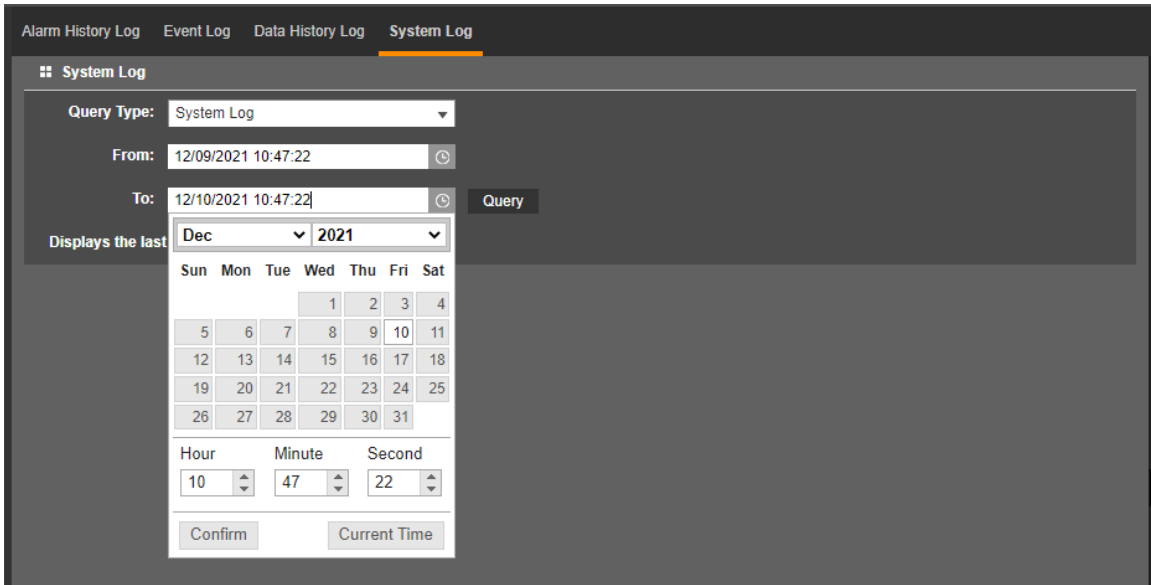
Index	Device Name	Signal Name	Value	Unit	Time
1	Inverter Group	Total Current	3.61	A	12-10-2021 10:21:07
2	Inverter Group	Total Output Power	0.39	kW	12-10-2021 10:21:07
3	Inverter Group	Total Current	3.64	A	12-10-2021 10:16:04
4	Inverter Group	Total Output Power	0.39	kW	12-10-2021 10:16:04

### System Log Tab

#### Select Time

Select the "from" and "to" time.

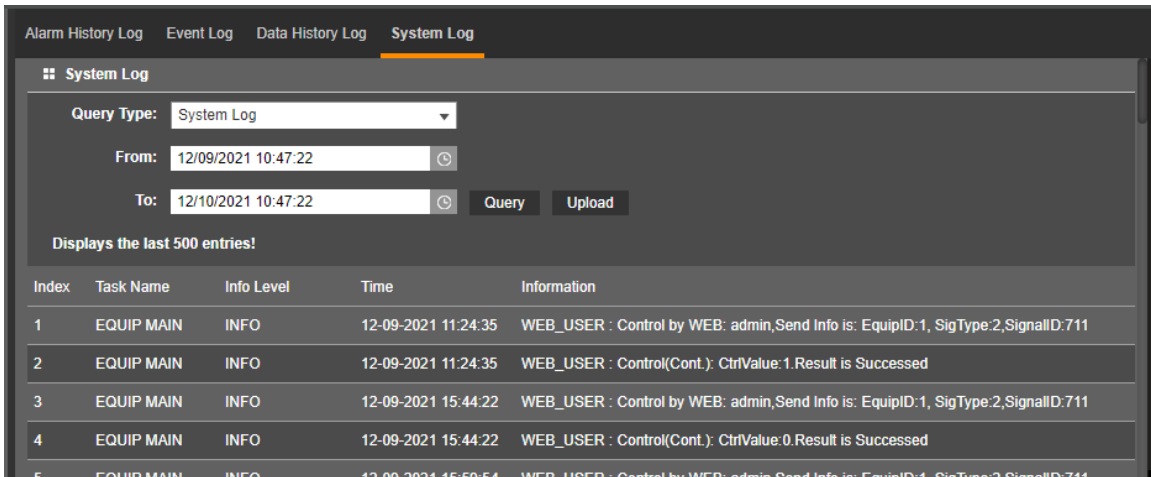
Figure 8.25 System Log Time Selection



#### Query System Log

Click "Query" to query the System Log. The Web page displays the last 500 entries.

Figure 8.26 System Log Query



Upload System Log

Click “Upload” to open the log into another window. You can then save the log as an .html (Web page) or .txt (text) file.

**Figure 8.27 System Log Upload**

Query System Log

Query Time: from 12-09-2021 10:47:22 to 12-10-2021 10:47:22

Total 277 record(s) queried.

Index	Task Name	Info Level	Log Time	Information
1	EQUIP MAIN	INFO	12-09-2021 11:24:35	WEB_USER : Control by WEB: admin,Send Info is: EquipID:1, SigType:2,SignalID:711
2	EQUIP MAIN	INFO	12-09-2021 11:24:35	WEB_USER : Control(Cont.): CtrlValue:1.Result is Succeeded
3	EQUIP MAIN	INFO	12-09-2021 15:44:22	WEB_USER : Control by WEB: admin,Send Info is: EquipID:1, SigType:2,SignalID:711
4	EQUIP MAIN	INFO	12-09-2021 15:44:22	WEB_USER : Control(Cont.): CtrlValue:0.Result is Succeeded
5	EQUIP MAIN	INFO	12-09-2021	WEB_USER : Control by WEB: admin,Send Info is: EquipID:1, SigType:2,SignalID:711

**System Inventory Menu**

The System Inventory Menu allows you to view product information of the intelligent devices (i.e., controller, inverters, etc.) in the system.

**Figure 8.28 System Inventory Menu**

Equipment	Product Model	Hardware Revision	Serial Number	Software Revision
NCU	M830D	A16	03190307690	1.2.45P03
Inverter #1	711201000	A00	16200900190	2.18
Inverter #2	711201000	A00	16200900193	2.16
Inverter #3	711201000	A00	16200900199	2.18
SM Temp 1	1SMTEMP	A01	03110300006	2.00
IB2-1	1MA4C5U31	A08	03151001817	1.03

## **Advanced Settings Menu**

The Advanced Settings Menu allows you to change (if you have the proper privilege level programmed in your User settings) the settings of the various advanced programmable parameters. Settings are grouped per function. Select a tab in the Advanced Settings Menu to change that functions programmable parameters.

### **Ethernet Tab**

You can configure the controller's network parameters. See "Ethernet Tab" on page 165.

### **Users Tab**

You can add, edit, and delete Users. These are the Users that can log onto the controller both locally (local display access) or remotely using the Web Interface. See "Users Tab" on page 166.

### **SNMP Tab**

Configures SNMP V2 and V3 parameters. See "SNMP Tab" on page 176.

### **Language Tab**

The local display and Web Interface always has an English language option. Multiple local languages are also supported. One local language option is displayed at a time with the English language option. To select another local language option to display, use the Web Interface Language Tab. See "Language Tab" on page 180.

### **SW Maintenance Tab**

Allows you to perform software maintenance procedures. See "SW Maintenance Tab" on page 182.

### **Alarms Tab**

Allows you to define the alarm level for each alarm. Allows you to map alarms to the alarm relays. See "Alarms Tab" on page 188.

### **DI Alarms Tab**

Allows you to change the digital input alarm signal full name (name displayed in the Web Interface menus). Allows you to change the digital input alarm signal abbreviation name (name displayed in the local display menus). Allows you to define the alarm level for each digital input alarm. Allows you to map the digital input alarms to the alarm relays. Allows you to set the alarm state for the digital inputs (high or low). See "DI Alarms Tab" on page 190.

### **DO (relay) Tab**

Allows you to use the relay test feature. Allows you to set the relay active or not active. Allows you to change the relay signal full name (name displayed in the Web Interface menus). See "DO (relay) Tab" on page 192.

### **Alarm Report Tab**

In the SMTP section, you can set the Alarm Report Feature. In the SMS section, you can set cell phone number for receiving alarm reports and the alarm report level. See "Alarm Report Tab" on page 208.

### **Monitor Protocol Tab**

You can select "EEM", "YDN23", "Modbus" or "TL1" as the protocol. See "Monitor Protocol Tab" on page 213.

### **Clear Data Tab**

Select the data log to be cleared from those listed in the drop-down list box. Click on the "Clear" button to clear the corresponding data. See also "Clear Data Tab" on page 218.

## 9 Replacement Procedures

### 9.1 Controller Replacement



**DANGER!** Follow all “Important Safety Instructions” found in the documentation provided with the system the controller is installed in.



**ALERT!** *CONTROLLER HANDLING.*

*Installation or removal of the controller requires careful handling. To avoid possibility of controller damage from static discharge, a static wrist strap grounded through a one megohm resistor should always be worn when handling the controller. ESD-protective packaging material must also be used when carrying/shipping the controller.*



**NOTE!** *Depending on your network security settings, when you remove a device that is connected to your network and assign the same IP address to the replacement device, you may not be allowed to communicate with the replacement device over the network. Contact your network administrator for assistance.*



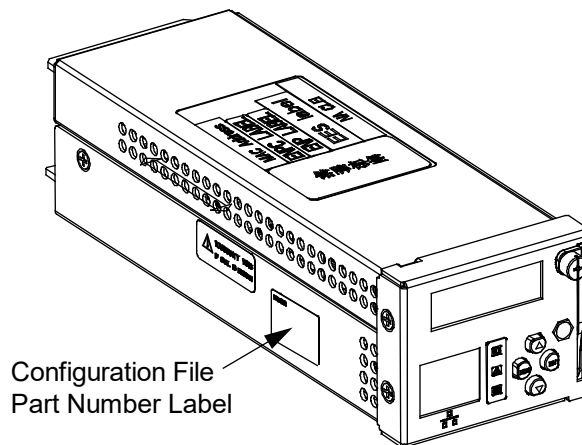
**NOTE!** *The controller does not turn off any relay when the controller is reset/replaced. If the relay is active when the controller is reset/replaced, it will stay active whether or not the alarm condition still exists. If possible, the alarm condition should be cleared before the controller is reset/replaced. If the alarm is not cleared, after starting the controller, it may be necessary to manually trigger an alarm condition to clear all alarm relays.*

The controller is hot swappable. It can be removed and installed with the system operating and without affecting the output bus.

#### **Procedure**

1. Before performing this procedure, ensure the replacement controller contains the same configuration file as the existing controller. Refer to the Configuration File Part Number Label on the side of the replacement controller for the Configuration Part Number (see Figure 9.1). If the existing controller is operational, navigate the menus to view its configuration file (MAIN SCREEN / ESC).

**Figure 9.1 Controller Configuration Label Location**

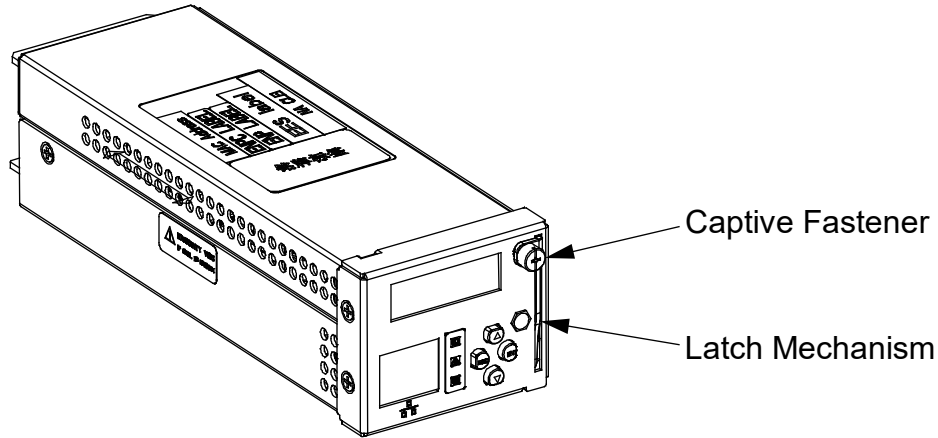


2. Performing this procedure may activate external alarms. Do one of the following. If possible, disable these alarms. If these alarms cannot be easily disabled, notify the appropriate personnel to disregard any future alarms associated with this system while this procedure is being performed.
3. Connect an approved grounding strap to your wrist. Attach the other end to a suitable ground.



- Loosen the captive fastener securing the latch mechanism to the front of the controller to be replaced. Pull the latch mechanism away from the controller (this will retract the latch mechanism located on the bottom of the controller). This unlocks the controller from the shelf. Refer to Figure 9.2.

**Figure 9.2 Latch Mechanism on the Controller**



- Slide the controller completely from the shelf.
- Loosen the captive fastener securing the latch mechanism to the front of the replacement controller. Pull the latch mechanism away from the controller (this will retract the latch mechanism located on the bottom of the controller).
- Slide the controller completely into its mounting position.
- Push the latch mechanism into the front panel of the controller, and secure by tightening the captive fastener. This locks the controller securely to the shelf.
- Wait for the controller to finish booting and verify that the complete system operates normally.
- Enable the external alarms, or notify appropriate personnel that this procedure is finished.
- Ensure that there are no local or remote alarms active on the system.

## 10 Controller Digital Input and Relay Output Connections

### 10.1 Controller Digital Inputs

The controller has two (2) programmable binary digital inputs for customer connections. These are factory wired to system interconnect connectors. Refer to your system documentation for location. Refer to “Specifications” on page 277 for ratings.



**NOTE!** Note that some digital inputs may be factory programmed for a specific use. Refer to the controller Configuration Drawing (C-drawing) furnished with your system.

### 10.2 Controller Relay Outputs

The controller has four (4) programmable form-C relay outputs for customer connections. Each relay output can be configured to change state when one or more alarm events occur. These are factory wired to system interconnect connectors. Refer to your system documentation for location. Refer to “Specifications” on page 277 for ratings.



**NOTE!** Note that some relay outputs may be factory programmed for a specific use. Refer to the controller Configuration Drawing (C-drawing) furnished with your system.

### 10.3 IB2 (Controller Interface Board) and EIB (Controller Extended Interface Board)

One or more IB2 (Controller Interface Board) and/or EIB (Controller Extended Interface Board) may be connected to the controller. The IB2 and EIB provide additional digital inputs and relay outputs. Note that some digital inputs and/or relay outputs may be factory wired to the system. Refer to your Power System documentation for IB2 and EIB connections and specifications.

# 11 Specifications

**Input Voltage Range:** 19 VDC to 60 VDC.

**Power Consumption, Maximum:** 5 W.

**Operating Temperature Range:** -40 °C to +75 °C (-40 °F to +167 °F).

**Relative Humidity:** Capable of operating in an ambient relative humidity range of 0% to 90%, non-condensing.

**Dimensions (H x W x D):**

- 43.5 mm (H) x 52 mm (W) x 152 mm (D)  
1.71" (H) x 2.05" (W) x 5.98" (D)

**Weight:** < 1 kg (2.2 lbs).

**Indicators:**

- Status (Green)
- Minor Alarm (Yellow)
- Critical / Major Alarm (Red)

**Local and Remote Access Passwords:** Refer to “Passwords and Privilege Levels” on page 19 and “Using the Web Interface” on page 20.

**Controller Digital Input Ratings:**

- Maximum Voltage Rating: 60 VDC.
- Active High: > 19 VDC.
- Active Low: < 1 VDC.

**Controller Relay Ratings:**

- Steady State: 0.5 A @ 60 VDC, 1.0 A @ 30 VDC.
- Peak: 3 A @ 30 VDC.

**IB2 and EIB (Controller Interface Board) Ratings:**

- **Digital Input Ratings:**
  - Maximum Voltage Rating: 60 VDC.
  - Active High: > 19 VDC.
  - Active Low: < 1 VDC.
- **Relay Ratings:**
  - Steady State: 0.5 A @ 60 VDC; 1.0 A @ 30 VDC.
  - Peak: 3 A @ 30 VDC.

**Factory Default Setpoints:** Refer to the Configuration Drawing (C-drawing) furnished with your system for a list of factory default values.

**Safety and Standards Compliance:**

- Electrical: IEC 60950-1, EN 60950-1, UL 60950-1
- EMC: EN 300 386, 2001 Class B; FCC Part 15, Class B
- Environmental: CE; NEBS Level 3 (pending)
- GR-3108 Class 2 Compliant (pending)

**Temperature Probe Accuracy:**

- Calibration Error (-25 °C to +105 °C):  $\pm 2$  °C
- Nonlinearity (-25 °C to +105 °C): 0.4 °C

**Controller Temperature Probe Input Accuracy (-10 °C to +65 °C):  $\pm 2$  °C**

## Connect with Vertiv on Social Media



<https://www.facebook.com/vertiv/>



<https://www.instagram.com/vertiv/>



<https://www.linkedin.com/company/vertiv/>



<https://www.twitter.com/vertiv/>



---

Vertiv.com | Vertiv Headquarters, 505 N Cleveland Ave, Westerville, OH 43082, USA

© 2023 Vertiv Group Corp. All rights reserved. Vertiv™ and the Vertiv logo are trademarks or registered trademarks of Vertiv Group Corp. All other names and logos referred to are trade names, trademarks or registered trademarks of their respective owners. While every precaution has been taken to ensure accuracy and completeness here, Vertiv Group Corp. assumes no responsibility, and disclaims all liability, for damages resulting from use of this information or for any errors or omissions.