



# Rectifier Module

## User Manual

Specification Number: 1R48500, 1R481000

Model Number: R48-500, R48-1000

The information contained in this document is subject to change without notice and may not be suitable for all applications. While every precaution has been taken to ensure the accuracy and completeness of this document, Vertiv assumes no responsibility and disclaims all liability for damages resulting from use of this information or for any errors or omissions. Refer to other local practices or building codes as applicable for the correct methods, tools, and materials to be used in performing procedures not specifically described in this document.

The products covered by this instruction manual are manufactured and/or sold by Vertiv. This document is the property of Vertiv and contains confidential and proprietary information owned by Vertiv. Any copying, use or disclosure of it without the written permission of Vertiv is strictly prohibited.

Names of companies and products are trademarks or registered trademarks of the respective companies. Any questions regarding usage of trademark names should be directed to the original manufacturer.

## Technical Support Site

If you encounter any installation or operational issues with your product, check the pertinent section of this manual to see if the issue can be resolved by following outlined procedures.

Visit <https://www.vertiv.com/en-us/support/> for additional assistance.

Visit <https://www.vertiv.com/en-emea/support/> for additional assistance.

Visit <https://www.vertiv.com/zh-CN/support/> for additional assistance.

# TABLE OF CONTENTS

- Admonishments Used in this Document.....iv**
- Important Safety Instructions.....v**
- Safety Admonishments Definitions.....v
- General Safety .....v
- Voltages.....v
- Hazardous Voltage .....v
- Handling Equipment Containing Static Sensitive Components.....v
- Static Warning .....vi**
- 1 Introduction.....1**
- 1.1 Overview.....1
- 1.2 Specifications.....1
- 2 Operation .....11**
- 2.1 AC Input Protection Device Requirements/Recommendations ..... 11
- 2.2 Local Indicators ..... 11
- 2.3 Rectifier High Voltage Shutdown and Lockout Restart .....12
- 2.4 Installing Rectifiers.....12
- 3 Troubleshooting and Repair .....13**
- 3.1 Troubleshooting.....13
- 3.2 Replacement Procedures.....14

## Admonishments Used in this Document



**DANGER!** Warns of a hazard the reader **will** be exposed to that will **likely** result in death or serious injury if not avoided. (ANSI, OSHA)



**WARNING!** Warns of a potential hazard the reader **may** be exposed to that **could** result in death or serious injury if not avoided. This admonition is not used for situations that pose a risk only to equipment, software, data, or service. (ANSI)



**CAUTION!** Warns of a potential hazard the reader **may** be exposed to that **could** result in minor or moderate injury if not avoided. (ANSI, OSHA) This admonition is not used for situations that pose a risk only to equipment, data, or service, even if such use appears to be permitted in some of the applicable standards. (OSHA)



**ALERT!** Alerts the reader to an action that **must be avoided** in order to protect equipment, software, data, or service. (ISO)



**ALERT!** Alerts the reader to an action that **must be performed** in order to prevent equipment damage, software corruption, data loss, or service interruption. (ISO)



**FIRE SAFETY!** Informs the reader of fire safety information, reminders, precautions, or policies, or of the locations of fire-fighting and fire-safety equipment. (ISO)



**SAFETY!** Informs the reader of general safety information, reminders, precautions, or policies not related to a particular source of hazard or to fire safety. (ISO, ANSI, OSHA)

# Important Safety Instructions

## Safety Admonishments Definitions

Definitions of the safety admonishments used in this document are listed under “Admonishments Used in this Document” on page iv.

## General Safety



**DANGER!** YOU MUST FOLLOW APPROVED SAFETY PROCEDURES.

Performing the following procedures may expose you to hazards. These procedures should be performed by qualified technicians familiar with the hazards associated with this type of equipment. These hazards may include shock, energy, and/or burns. To avoid these hazards:

- a) The tasks should be performed in the order indicated.
- b) Remove watches, rings, and other metal objects.
- c) Prior to contacting any uninsulated surface or termination, use a voltmeter to verify that no voltage or the expected voltage is present. Check for voltage with both AC and DC voltmeters prior to making contact.
- d) Wear eye protection.
- e) Use certified and well maintained insulated tools. Use double insulated tools appropriately rated for the work to be performed.

## Voltages

### AC Input Voltages



**DANGER!** This system operates from AC input voltage capable of producing fatal electrical shock.

### DC Output and Battery Voltages



**DANGER!** This system produces DC power and may have a battery source connected to it. Although the DC voltage is not hazardously high, the rectifiers and/or battery can deliver large amounts of current. Exercise extreme caution not to inadvertently contact or have any tool inadvertently contact an output terminal or battery terminal or exposed wire connected to an output terminal or battery terminal. NEVER allow a metal object, such as a tool, to contact more than one termination or battery terminal at a time, or to simultaneously contact a termination or battery terminal and a grounded object. Even a momentary short circuit can cause sparking, explosion, and injury.

## Hazardous Voltage



**DANGER!** HAZARD OF ELECTRICAL SHOCK.

More than one disconnect may be required to de-energize the system before servicing.

## Handling Equipment Containing Static Sensitive Components



**ALERT!** Installation or removal of equipment containing static sensitive components requires careful handling. Before handling any equipment containing static sensitive components, read and follow the instructions under “Static Warning” on page vi.

## Static Warning



This equipment contains static sensitive components. The warnings listed below must be observed to prevent damage to these components. Disregarding any of these warnings may result in personal injury or damage to the equipment.

1. Strictly adhere to the procedures provided in this document.
2. Before touching any equipment containing static sensitive components, discharge all static electricity from yourself by wearing a wrist strap grounded through a one megohm resistor. Some wrist straps have a built-in one megohm resistor; no external resistor is necessary. Read and follow wrist strap manufacturer's instructions outlining use of a specific wrist strap.
3. Do not touch traces or components on equipment containing static sensitive components. Handle equipment containing static sensitive components only by the edges that do not have connector pads.
4. After removing equipment containing static sensitive components, place the equipment only on static dissipative surfaces such as conductive foam or ESD bag. Do not use ordinary Styrofoam or ordinary plastic.
5. Store and ship equipment containing static sensitive components only in static shielding containers.
6. If necessary to repair equipment containing static sensitive components, wear an appropriately grounded wrist strap, work on a conductive surface, use a grounded soldering iron, and use grounded test equipment.

# 1 Introduction

## 1.1 Overview

The rectifiers provide load power, battery float current, and battery recharge current during normal operating conditions. The rectifiers are a constant power design. The rectifiers are rated at their maximum output power. This means that, within the normal operating ambient temperature range and input voltage range, the maximum available output power is a constant 500W or 1000W (depending on rectifier model). Within these ranges, the rectifiers operate in one of three modes, depending upon load demands. Transition between modes is completely automatic. If ambient temperature rises above or input voltage falls below acceptable values, rectifiers continue to operate but at derated output power levels.

- Constant Voltage Mode: For any initial output voltage setting from 42 to 58 volts, output voltage remains constant regardless of load. This is the normal operating condition, in which loads are being supplied and batteries are float charged. Rectifiers operate in the Constant Voltage Mode unless load increases to the point where the product of load current and output voltage is approximately 500W or 1000W (depending on rectifier model).
- Constant Power Mode: As load increases above approximately 500W or 1000W (depending on rectifier model) (non-adjustable), output current continues to increase, but output voltage decreases as required to maintain constant output power. Rectifiers operate in the Constant Power Mode unless load continues to increase to the point where the current limit setting is reached.
- Constant Current Mode: If load increases to the current limit setting, output voltage decreases linearly to maintain output current at the current limit setting.

## 1.2 Specifications

### 1.2.1 DC Output Ratings

- Voltage: Nominal -48.0 VDC, Positive Ground.
  - a) Adjustment Range: The output voltage can be set within the range of -42V to -58V, adjustable via the controller.
- Output Power and Current:
  - a) R48-500 (1R48500): 500W (10.5A) @ -48 VDC. See **Figure 1.1**.
  - b) R48-1000 (1R481000): 1000W (20.9A) @ -48 VDC. See **Figure 1.2**.
- Power Derating Based on Input Voltage:
  - a) R48-500 (1R48500): The rectifier can provide maximum rated power (500W) as long as the input voltage is within the range of 90 to 300 VAC. The relationship between the output power and input voltage is illustrated in **Figure 1.3**.
  - b) R48-1000 (1R481000): The rectifier can provide maximum rated power (1000W) as long as the input voltage is within the range of 176 to 300 VAC. From 176 VAC to 90 VAC, the rectifier will continue to operate, but maximum power is reduced. The relationship between the output power and input voltage is illustrated in **Figure 1.4**.
- Power Derating Based on Temperature: The rectifier delivers full power when operating at an ambient temperature of +45°C (+113°F) or below. Refer to **Figure 1.5** or **Figure 1.6** to view the relationship between the output power and the ambient temperature.

Figure 1.1 Output Voltage vs. Output Current [R48-500 (1R48500)]

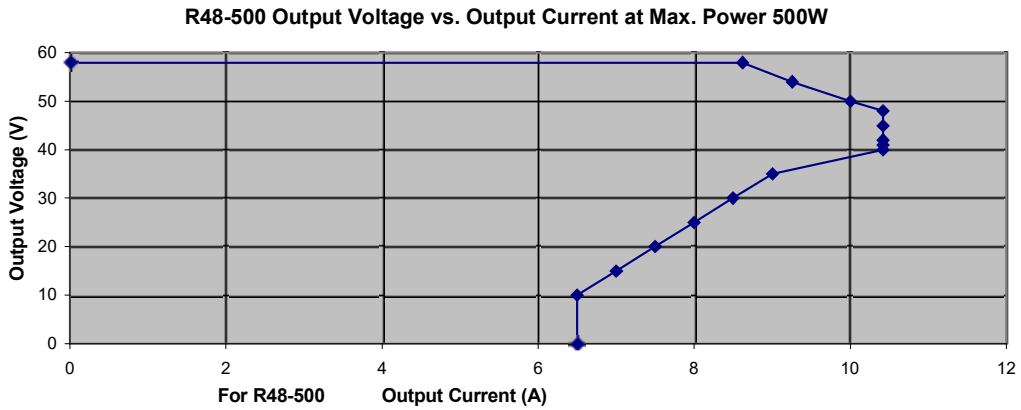

Figure 1.2 Output Voltage vs. Output Current [R48-1000 (1R481000)]

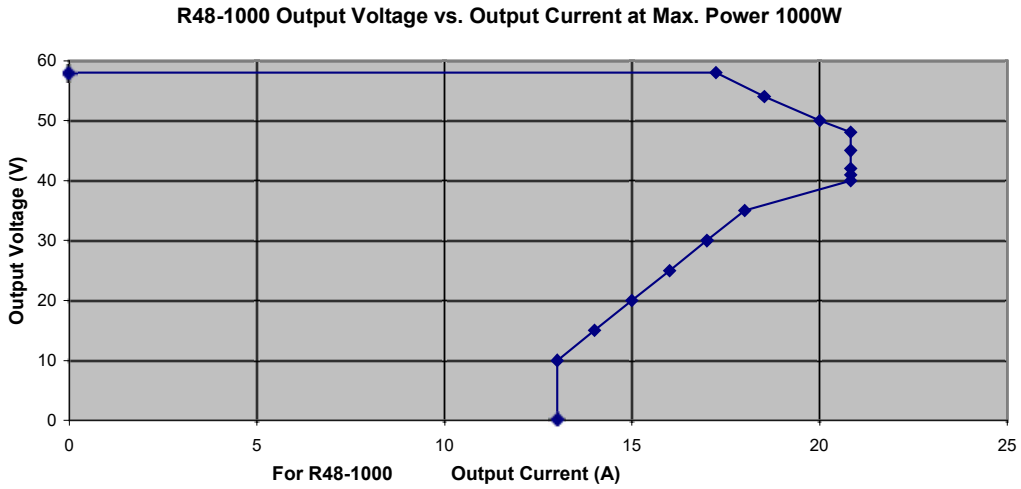

Figure 1.3 Power Derating Based on Voltage [R48-500 (1R48500)]

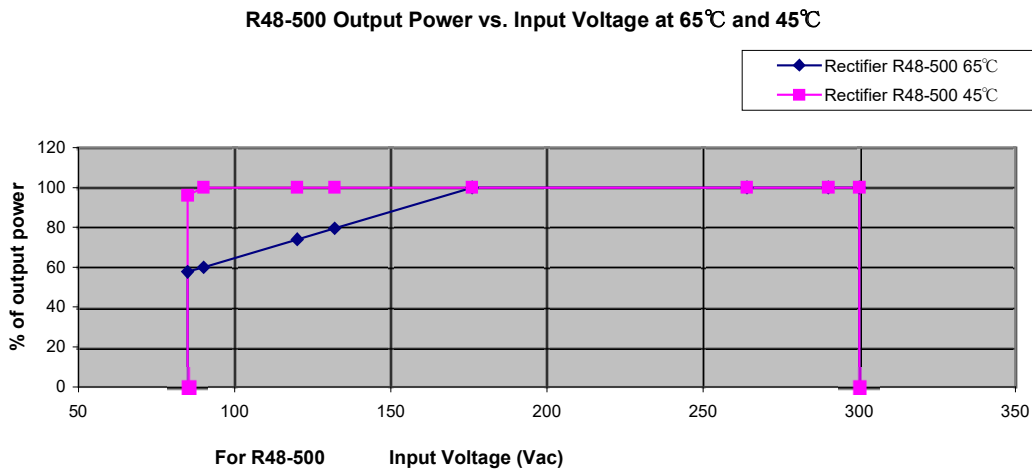



Figure 1.4 Power Derating Based on Voltage [R48-1000 (1R481000)]

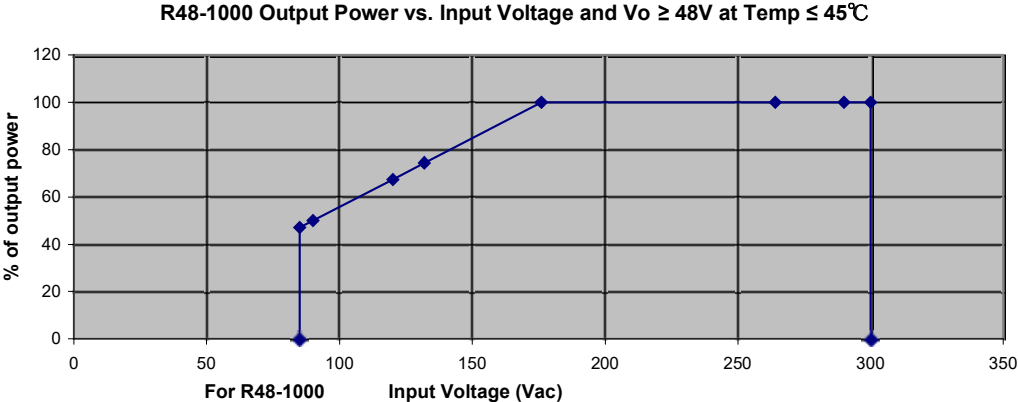

Figure 1.5 Power Derating Based on Temperature [R48-500 (1R48500)]

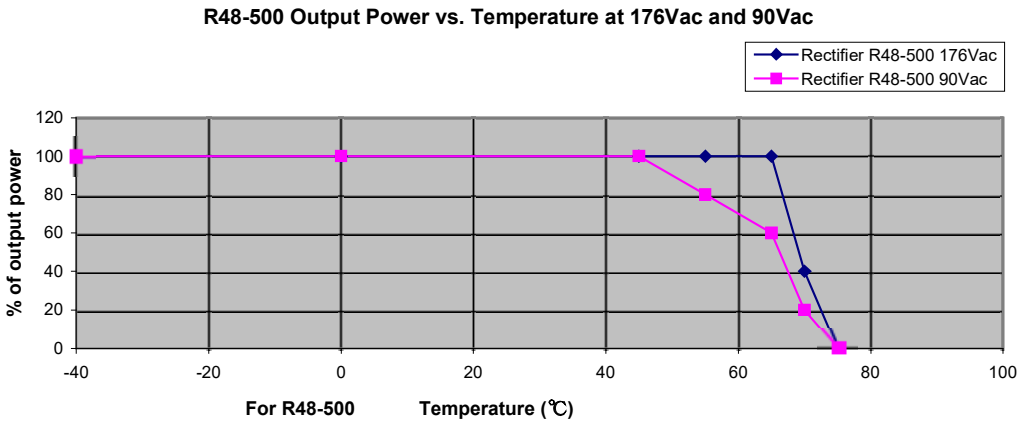
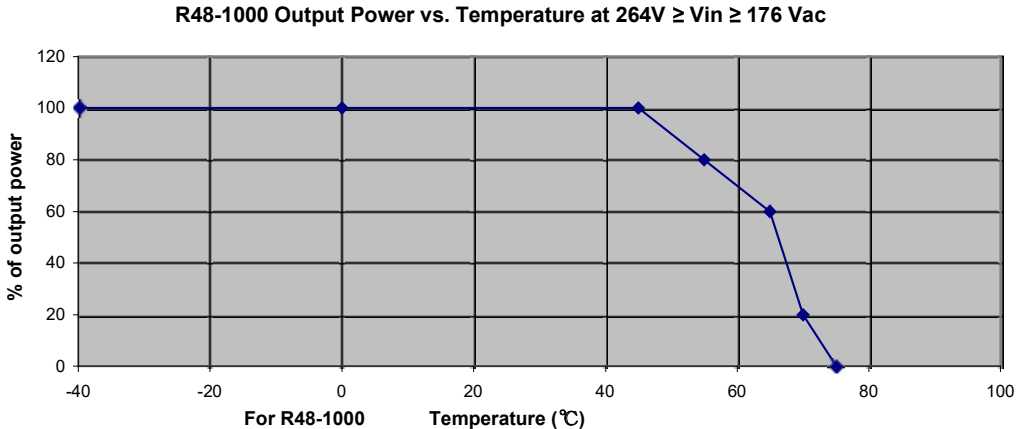

Figure 1.6 Power Derating Based on Temperature [R48-1000 (1R481000)]



- Regulation:
  - a) Static: Steady state regulation is  $\pm 0.5\%$  as controlled within the rectifier for any and all combinations of load from no load to full load, input voltage, and input frequency at a constant ambient temperature. The associated system controller may provide increased regulation.
  - b) Dynamic: For any step load change within the range of 10% to 90% of full load within 50 microseconds, per Telcordia GR-947-CORE, the maximum voltage transient will not exceed 5% of the initial steady state voltage within  $50 \pm 10$  microseconds. Recovery to within 1% of the initial steady state voltage does not exceed 4 milliseconds.
- Filtering:
  - a) Voice Band Noise: Complies with Telcordia GR-947-CORE.
    7. Output noise according to Telcordia GR-947-CORE is  $< 32$  dBnC at normal input and full load.
    8. Psophometric noise is  $\leq 1$  mV at 5% to 100% of rated load.
  - b) Wide Band Noise: Complies with Telcordia GR-947-CORE.
    1. Wideband noise emission is  $< 250$  mV peak to peak between 0 Hz – 30 MHz, and  $< 100$  mV rms in any 3 kHz band 10 – 20 MHz.

## 1.2.2 AC Input Ratings

- Voltage: Nominal 120/208/240 volts AC, single phase, 3-wire, 50/60 Hz, with an operating range of 100 to 250 volts. Acceptable input frequency range is 45 to 65 Hz.
  - a) Permitted Variation: 85 to 300 VAC.
- Harmonic Content (THD):  $\leq 5\%$  from 50% to 100% of rated load. Meets EN61000-3-2.
- Inrush Current: Peak does not exceed 1.5 times of the peak value of the maximum steady-state input current at full load, nominal input voltage, and for any duration of AC input interrupts. Under the above conditions, standard AC distribution circuit breakers will not trip.
- Typical Input Data (1R48500): 60 Hz input.
  - a) System output is initially adjusted to 54.48 volts DC as measured at the system sense point at 50% of full load and nominal input. “Percent of Full Load” refers to percent of 8.62 amperes.

Nominal Input Voltage	Percent of Full Load	Input Current (Amperes)	Input VA	Input Watts	Power Factor %	Efficiency %	Heat Dissipation BTU/Hr
208	0	0.23	48	11	23.1	--	38.23
	25	0.76	157	146	93.0	77.9	110.16
	50	1.31	271	261	96.1	88.6	101.75
	75	1.88	390	384	98.3	90.5	124.25
	100	2.51	522	517	99.1	91.5	150.68
	110	2.74	569	565	99.3	91.6	161.65
	120	2.80	580	576	99.3	91.8	162.15
240	0	0.27	65	11	17.2	--	37.88
	25	0.67	160	138	86.0	82.6	82.09
	50	1.13	273	260	95.1	88.9	98.34
	75	1.65	396	382	96.6	90.8	120.00
	100	2.18	525	516	98.2	91.7	145.79
	110	2.38	572	564	98.5	91.9	156.23
	120	2.43	584	575	98.4	92.0	156.85

- b) Maximum Input Current: at 100% of full load with output adjusted to 58 volts DC as measured at the shelf output terminals.

Nominal Input Voltage	Input Voltage	Input Current (Amperes)
208/240	176	2.98

- Typical Input Data (1R481000): 60 Hz input.
  - a) System output is initially adjusted to 54.48 volts DC as measured at the system sense point at 50% of full load and nominal input. “Percent of Full Load” refers to percent of 17.24 amperes.

Nominal Input Voltage	Percent of Full Load	Input Current (Amperes)	Input VA	Input Watts	Power Factor %	Efficiency %	Heat Dissipation BTU/Hr
208	0	0.23	49	11	23.0	--	38.23
	25	1.30	272	261	96.0	88.6	101.59
	50	2.50	522	517	99.1	91.5	149.88
	75	3.71	772	769	99.7	91.8	215.90
	100	4.94	1028	1027	99.9	91.4	301.84
	110	5.36	1115	1114	99.9	91.1	336.50
	120	5.41	1124	1123	99.9	90.8	351.17
240	0	0.27	65	11	17.1	--	38.23
	25	1.13	273	260	95.1	89.0	97.49
	50	2.18	525	516	98.2	91.8	144.71
	75	3.21	772	766	99.3	92.1	205.40
	100	4.27	1026	1022	99.6	91.9	284.14
	110	4.62	1111	1108	99.7	91.6	316.04
	120	4.66	1120	1117	99.7	91.2	334.34

- b) Maximum Input Current: at 100% of full load with output adjusted to 58 volts DC as measured at the shelf output terminals.

Nominal Input Voltage	Input Voltage	Input Current (Amperes)
208/240	176	628

### 1.2.3 Environmental Ratings

- Operating Ambient Temperature Range:
  - a) -40°C (-40°F) to +75°C (+167°F) with derating output.
  - b) -40°C (-40°F) to +45°C (+113°F) with full power performance.
  - c) Temperature Coefficient: 0.01% per degrees Celsius.
- Storage Ambient Temperature Range: -40°C (-40°F) to +75°C (+167°F).
- Relative Humidity: This rectifier is capable of operating in an ambient relative humidity range of 0% to 95%, non-condensing.
- Altitude: 2000 m (6560 ft) at full power (power limited for heights above 2000 m).
- Surge Protection: Compliance with EN61000-4-5 (2kV Line to Line, 2kV Line to Earth). Capable of withstanding surges per ANSI/IEEE C 62.41 1980 Category B3 across the input terminals.



**NOTE!** *This level of protection is a widely used standard for telecommunications power equipment. As with all such equipment, it is the end user's responsibility to provide an adequately sized Surge Suppression Device at the commercial power service entrance of the building that reduces all incoming surges to levels below the classes/categories stated for the equipment.*

- Ventilation Requirements: The rectifiers are fan cooled and utilize front to back forced ventilation. A rectifier must be mounted so ventilating openings are not blocked and temperature of the air entering the rectifier does not exceed the Operating Ambient Temperature Range stated above.
- Single Rectifier Audible Noise:
  - a) At 25°C ≤ 60dB(A) with fan in high speed; Measurement made at 0.6m distance in front of rectifier and at same horizontal line of the middle of rectifier.
  - b) At 25°C ≤ 50dB(A) with fan in low speed; Measurement made at 0.6m distance in front of rectifier and at same horizontal line of the middle of rectifier.
- EMI/RFI Suppression: Rectifier operating in a Module Mounting Shelf conform to the requirements of FCC rules Part 15, Subpart B, Class B for Radiated and Conducted emissions limits.

### 1.2.4 Compliance Information

- EMC: ETSI EN 300 386 class B, FCC CFR 47 Part 15 class B, Telcordia GR-1089-CORE class B.
- Safety: IEC 60950, EN 60950, UL 60950.

### 1.2.5 Standard Features

- Type of Power Conversion Circuit: High frequency.
- Constant Voltage Mode: For any initial output voltage setting from 42 to 58 volts, output voltage remains constant regardless of load. This is the normal operating condition, in which loads are being supplied and batteries are float charged. Rectifiers operate in the Constant Voltage Mode unless load increases to the point where the product of load current and output voltage is approximately 500W or 1000W (depending on rectifier model).
- Constant Power Mode: As load increases above approximately 500W or 1000W (depending on rectifier model) (non-adjustable), output current continues to increase, but output voltage decreases as required to maintain constant output

power. Rectifiers operate in the Constant Power Mode unless load continues to increase to the point where the current limit setting is reached.

- Constant Current Mode: If load increases to the current limit setting, output voltage decreases linearly to maintain output current at the current limit setting.
- Input Protection:
  - a) Input Over/Under Voltage Protection: The rectifier will shut down at low or high voltage input; based on the following voltage levels:
    1. Low voltage disable point 80 V,  $\pm 5$  V; hysteresis is 10 - 20 VAC for restart.
    2. High voltage disable point 305 V,  $\pm 5$  V; hysteresis is 10 - 15 VAC for restart.
  - b) R48-500 (1R48500): Output power is not derated with input voltage.  
R48-1000 (1R481000): Output power derates linearly from 1000W to 500W between 176VAC and 90VAC. When input voltage is greater than 176VAC, output power remains at 1000W.
- Output Protection:
  - a) Overload / Reverse Current: The rectifier has a 28A fuse wire in the negative output DC bus. This fuse is not customer replaceable. The rectifier can be plugged into or pulled out of a shelf while operating, without damage or opening the fuse.
  - b) Current Limiting: The rectifier has a current limit function. The current limit point can be set between the range of 0.862A to 10.344A (R48-500 [1R48500]) or 1.724A to 20.688A (R48- 1000 [1R481000]), adjustable via the controller. The current limit accuracy is less than [0, 2A] when the output voltage ranges from 42 to 58V.
  - c) Advanced Current Limit Function: The rectifier has an advanced Current Limit Function. When a short circuit occurs at the rectifier output terminals, the rectifier will keep its output current at a constant value (value that is configurable via the controller). This function effectively protects the rectifier and the equipment connected to the rectifier. When the short circuit fault is cleared, the rectifier will automatically restore back to normal operation.
  - d) High Voltage Shutdown:
    1. Adjustable Control: If rectifier output voltage exceeds an adjustable preset value and the rectifier is delivering more than 10% of its rated current, the rectifier shuts down. (Adjustable from 56 VDC to 59 VDC via the controller. The restart hysteresis is 0.5 V  $\pm$ 0.2 V.)  
  
 The rectifier then restarts and a HVSD restart timer starts (time value configurable via the controller, factory default is 5 minutes). If output voltage again exceeds the high voltage shutdown value before the HVSD restart timer expires, the rectifier shuts down and locks out. Manual restart is then required (by turning power to the rectifier off or by removing the rectifier, waiting until the LEDs on the rectifier extinguish, then turning power to the rectifier on or re-inserting the rectifier). If the rectifier does not experience a high voltage condition before the HVSD restart timer expires, the restart circuit is reset.  
  
 If two or more rectifiers are paralleled, only the rectifier causing the high voltage condition shuts down.
    2. Backup: If rectifier output voltage exceeds 59.5 V  $\pm$ 0.5 V (non-adjustable) and the rectifier is delivering more than 10% of its rated current, the rectifier shuts down. The rectifier then restarts and a HVSD restart timer starts (time value configurable via the controller, factory default is 5 minutes). If output voltage again exceeds the high voltage shutdown value before the HVSD restart timer expires, the rectifier shuts down and locks out. Manual restart is then required (by turning power to the rectifier off or by removing the rectifier, waiting until the LEDs on the rectifier extinguish, then turning power to the rectifier on or re-inserting the rectifier).

- Over-Temperature Protection: The rectifier provides over temperature protection by derating output power and recovers automatically.
- Active Load Sharing: The rectifier uses advanced digital active load sharing technology that maintains balancing to within 3% of rated current.
- Hot Swappable: The rectifier is designed to be plug-and-play. The rectifier can be inserted or removed from a live DC power system with no damage. When the rectifier is plugged into the system, the system output voltage will not be affected.
- Fan Control: When the input voltage is within a normal range, the built-in processor adjusts the fan's speed according to the rectifier ambient and internal temperature. This feature can be disabled allowing the fan to run at full speed regardless of temperature.
- Fan Fault Protection: An alarm will be generated upon a fan fault. In such cases, the fault indicator (red) on the rectifier front panel will flash and the rectifier will also inhibit its output. Auto recovery is enabled upon the clearing of the corresponding fault.
- Communication Failure: The rectifier's protection indicator (yellow) will flash should it experience a communication failure. The failure information will be reported to the controller and the controller will process the failure accordingly. During a communication failure, in order to protect the battery, the rectifier output voltage will automatically be adjusted as follows.
  - The rectifier default factory output voltage is 53.5V.
  - Once power is applied to the rectifier and the rectifier is recognized by the controller, the output voltage is updated to the setting programmed into the controller.
  - If communications with an SCU+ controller is lost, rectifier output voltage goes to a default value programmed into the controller (this is a separate programmable parameter from the output voltage setting).
  - If communications with an ACU+ or NCU controller is lost, rectifier output voltage goes to the last communicated float output voltage setting in the controller (the last communicated float output voltage setting is stored in the rectifier).
  - The rectifier will revert to normal operation once normal communication to the controller is restored.
- Imbalance of Rectifier Output Current:
  - a) When the average current of all rectifier modules is greater than 20% of full rated current, and the difference between local rectifier current and average current is greater than 16% of full rated current, the yellow protection indicator will illuminate.
  - b) When the average current of all rectifier modules is greater than 10% of full rated current, and local rectifier current is less than 2% of full rated current, then the red fault indicator will illuminate.
- Monitoring Function: The rectifier has a built-in advanced DSP that monitors and controls the operation of the rectifier. The DSP also communicates with the controller in real time through the CAN bus. **Table 1.1** lists the different commands and information exchanged between the rectifier and the controller.
- External Control Circuits: Provided via the associated controller. Refer to the separate Power System documentation for a complete description of available external control circuits.
- External Alarm Circuits: Provided via the associated controller. Refer to the separate Power System documentation for a description of available external alarms.

**Table 1.1 Exchange of Information between Rectifier and Controller**

Commands / signals that can be received by the Rectifier Module from the Controller.	Information gathered by the Controller from the Rectifier Module.
<ul style="list-style-type: none"> <li>• Turn On/Off</li> <li>• Voltage Walk-in On/Off</li> <li>• HVSD Reset</li> <li>• Current Limit Adjustment</li> <li>• Voltage Adjustment</li> </ul>	<ul style="list-style-type: none"> <li>• Input Voltage</li> <li>• Output Voltage</li> <li>• Output Current</li> <li>• Current Limit Setting</li> <li>• Temperature</li> <li>• Over Voltage Setting</li> <li>• On/Off Status</li> <li>• Fault Alarms, such as:                             <ul style="list-style-type: none"> <li>HVSD</li> <li>Fan Fail</li> </ul> </li> <li>• Protection Alarms, such as:                             <ul style="list-style-type: none"> <li>Input Voltage Protection</li> <li>Inner DC Bus Voltage Protection</li> <li>High Temperature Protection</li> </ul> </li> <li>• Thermal Derating</li> <li>• AC Derating</li> <li>• AC Fail</li> <li>• Imbalanced Output Current</li> <li>• Address</li> <li>• Code</li> <li>• Date</li> <li>• Software Version</li> <li>• Hardware Version</li> </ul>

## 1.2.6 Mechanical Specifications

- Dimensions:
  - a) Millimeters: 40.8 (Height) X 86.5 (Width) X 241 (Depth).
  - b) Inches: 1.6 (Height) X 3.4 (Width) X 9.5 (Depth).
- Weight: 1.25 kg (2.76 lbs).
- Indicators:
  - a) Power (Green)
  - b) Protection (Yellow)
  - c) Alarm (Red)



## 2 Operation

### 2.1 AC Input Protection Device Requirements/Recommendations

Refer to the system documentation supplied with the system the rectifier is installed in.

### 2.2 Local Indicators



Location and Identification: Refer to **Figure 2.1**.

Description: There are three (3) indicators located on the rectifier's front panel. The functions of these indicators are as shown in **Table 2.1**.

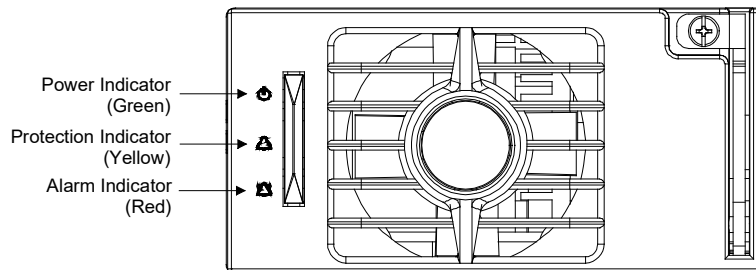
**Figure 2.1** Local Indicator Locations



**Table 2.1** Local Indicators

Indicator	Normal State	Alarm State	Alarm Cause
 Power (Green)	On	Off	No input voltage. Internal input fuse open.
		Flashing	The rectifier is being identified by the controller.
 Protection (Yellow)	Off	On	AC input under/over voltage. PFC output under/over voltage. Moderate load sharing imbalance. Rectifier not inserted into the slot completely. Rectifier over-temperature protection. Rectifier in ECO Standby Mode when ECO Mode is active in controller.
		Flashing	Loss of communication with controller (the rectifier can provide power).
 Alarm (Red)	Off	On	Severe load sharing imbalance. Rectifier output disabled for any reason, including overvoltage shutdown and internal output fuse open. Rectifier addresses contradictory.
		Flashing	Fan not operating (rectifier shuts down).

## 2.3 Rectifier High Voltage Shutdown and Lockout Restart

### Procedure

1. Turn the power to the rectifier off or remove the rectifier, wait 30 seconds or more (until the LEDs on the rectifier extinguish), then turn the power to the rectifier on or re-insert the rectifier.

## 2.4 Installing Rectifiers

The rectifier is hot swappable. It can be installed with the system operating.



**WARNING!** To prevent damage to the latching mechanism, ensure the handle is in the open position when installing or removing a module. NEVER hold the handle in the closed position when installing a module into a shelf.

### Procedure

1. Place the rectifier into an unoccupied mounting slot without sliding it in completely.
2. Loosen the captive fastener securing the top of the latch mechanism to the front of the rectifier. Pull the top of the latch mechanism away from the rectifier (this will retract the latch mechanism located on the underside of the rectifier). Refer to **Figure 2.2** for latch mechanism illustration.
3. Push the rectifier completely into the shelf.
4. Push the top of the latch mechanism into the front panel of the rectifier, and secure by tightening the captive fastener. This locks the rectifier securely to the shelf.
5. Repeat the above steps for each rectifier being installed in the system.
6. After the rectifiers are physically installed in the mounting shelf(s), they are ready for operation immediately after power is supplied to them.
7. Certain functions (i.e. rectifier current limit, rectifier addressing) may require adjustment when adding or replacing a rectifier. Refer to the Power System documentation for instructions.

**Figure 2.2** Installing a Rectifier

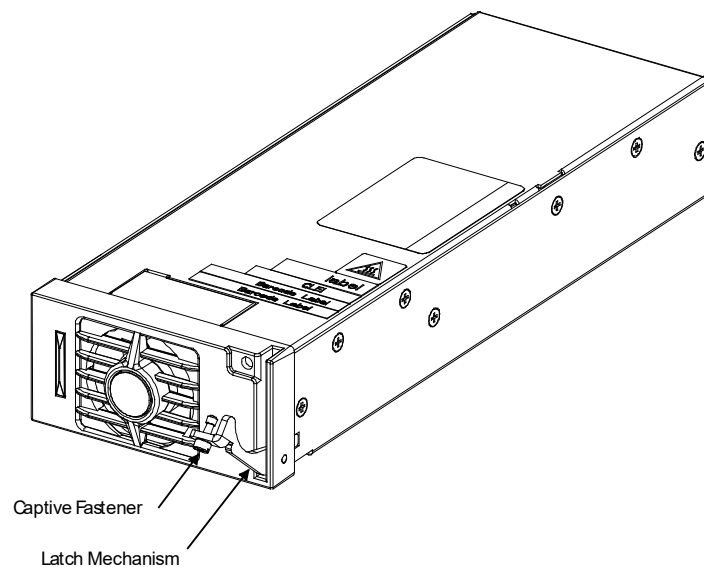

## 3 Troubleshooting and Repair

### 3.1 Troubleshooting

#### 3.1.1 Rectifier Current Sharing Imbalance

When multiple rectifiers are operating in parallel and the current sharing imbalance among them is greater than 20%, check if the rectifier is properly seated in the Power/Distribution Shelf.



If the current sharing imbalance still persists following the verification suggested above, replace the rectifier which has had its current sharing function disabled.

#### 3.1.2 Rectifier Fault Symptoms and Troubleshooting

The fault indicators that can be displayed by the rectifier are as follows. Refer to **Table 3.1** for a list of possible causes and corrective actions.

- Power indicator (Green) OFF
- Protection indicator (Yellow) ON
- Protection indicator (Yellow) flashing
- Alarm indicator (Red) ON
- Alarm indicator (Red) flashing

**Table 3.1 Rectifier Troubleshooting**

Symptom		Possible Cause(s)	Suggested Action(s)
	Power Indicator (Green) Off	No input voltage.	Make sure there is input voltage.
		Internal input fuse open.	Replace the rectifier.
	Protection Indicator (Yellow) On	AC input under/over voltage.	Correct the AC input voltage to within the acceptable range.
		PFC under/over voltage.	Replace the rectifier.
		Moderate load sharing imbalance.	Check if the rectifier is properly seated in the module mounting assembly. If this does not correct the fault, replace the rectifier.
		Rectifier not inserted into the slot completely.	Remove and properly insert the rectifier.
		Rectifier over-temperature protection.	Fan rotor blocked: remove any object that may be blocking the fan. Ventilation blocked (inlet or outlet): remove any object that may be blocking the inlet or outlet. Ambient temperature too high or rectifier inlet too close to a heat source: lower the ambient temperature or relocate the heat source.
	Rectifier in ECO Standby Mode when ECO Mode is active in controller.	--	
Protection Indicator (Yellow) Flashing	Loss of communication with controller (the rectifier can provide power).	Check the communication cables. Remove and properly insert the rectifier and controller.	
	Alarm Indicator (Red) On	Severe load sharing imbalance. Rectifier output disabled for any reason, including overvoltage shutdown and internal output fuse open. Rectifier addresses contradictory.	Turn AC power to the rectifier off or remove the rectifier, wait 30 seconds or more (until the LEDs on the rectifier extinguish), then turn the AC power to the rectifier on or re-insert the rectifier. If rectifier fails to start, shuts down again, or load sharing imbalance persists; replace the rectifier.
	Alarm Indicator (Red) Flashing	Fan not operating (rectifier shuts down).	Replace the fan.

## 3.2 Replacement Procedures

### 3.2.1 Rectifier Replacement



**DANGER!** Take care when removing a rectifier that was in operation, as rectifier surfaces could be very hot.



**WARNING!** To prevent damage to the latching mechanism, ensure the handle is in the open position when installing or removing a rectifier Module. NEVER hold the handle in the closed position when installing a rectifier into a shelf.

The rectifier is hot swappable. It can be removed and installed with the system operating.

#### **Procedure**

1. Performing this procedure may activate external alarms. Do one of the following. If possible, disable these alarms. If these alarms cannot be easily disabled, notify the appropriate personnel to disregard any alarms associated with this system while this procedure is performed.
2. On the rectifier to be removed, loosen the captive fastener securing the top of the latch mechanism to the front of the rectifier. Pull the top of the latch mechanism away from the rectifier (this will retract the latch mechanism located on the underside of the rectifier). This unlocks the rectifier from the shelf. Refer to **Figure 2.2** for latch mechanism illustration.
3. Slide the rectifier out by pulling forwards.
4. Place the replacement rectifier into the mounting position without sliding it in completely.

5. On the replacement rectifier, loosen the captive fastener securing the top of the latch mechanism to the front of the rectifier. Pull the top of the latch mechanism away from the rectifier (this will retract the latch mechanism located on the underside of the rectifier).
6. Push the rectifier completely into the shelf.
7. Push the top of the latch mechanism into the front panel of the rectifier, and secure by tightening the captive fastener. This locks the rectifier securely to the shelf.
8. Certain functions (i.e. rectifier current limit, rectifier addressing) may require adjustment when adding or replacing a rectifier. Refer to the Power System documentation for instructions.
9. After the rectifiers are physically installed in the mounting shelf(s), they are ready for operation immediately after power is supplied to them. Verify that the rectifiers are operating normally.
10. Enable the external alarms, or notify appropriate personnel that this procedure is finished.
11. Ensure that there are no local or remote alarms active on the system.

### 3.2.2 Rectifier Fan Replacement

Each rectifier uses a fan (P/N 32010093) for cooling. If fan replacement should become necessary, perform the following procedure.

Refer to **Figure 3.1** as this procedure is performed.



**WARNING!** In a system with NO redundant rectifier, battery must have sufficient reserve to power the load(s) while the rectifier is removed for fan replacement.



**NOTE!** When performing any step in this procedure that requires removal of existing hardware, retain all hardware for use in subsequent steps.

#### **Procedure**

1. Performing this procedure may activate external alarms. Do one of the following. If possible, disable these alarms. If these alarms cannot be easily disabled, notify the appropriate personnel to disregard any alarms associated with this system while this procedure is performed.
2. Remove the rectifier from the shelf. Refer to a previous procedure for step-by-step instructions.
3. Place the rectifier on a static-safe work surface. Connect an approved grounding strap to your wrist for the remainder of this procedure.
4. On this rectifier; remove the screws securing the rectifier front cover and remove the cover.
5. For proper orientation of the new fan, observe the location of the fan wires and the air flow arrows on the old fan.
6. Remove the old fan, and unplug the fan from the rectifier.
7. Place the new fan in the space vacated by the old fan (ensure the fan wires and air flow arrows match the orientation of the old fan), and plug it into the rectifier.
8. Replace the rectifier front cover and secure it with the screws previously removed.
9. Replace the rectifier into the shelf. Refer to the previous procedure for step-by-step instructions.
10. When the fans start, check to ensure that each is providing front-to-back airflow. If air direction is wrong, immediately remove the rectifier from the shelf. Repeat previous steps to check fan orientation, and correct as necessary. Reinstall the rectifier and again check for proper airflow.

11. Enable the external alarms, or notify appropriate personnel that this procedure is finished.
12. Ensure that there are no local or remote alarms active on the system.

**Figure 3.1 Rectifier Fan Replacement**

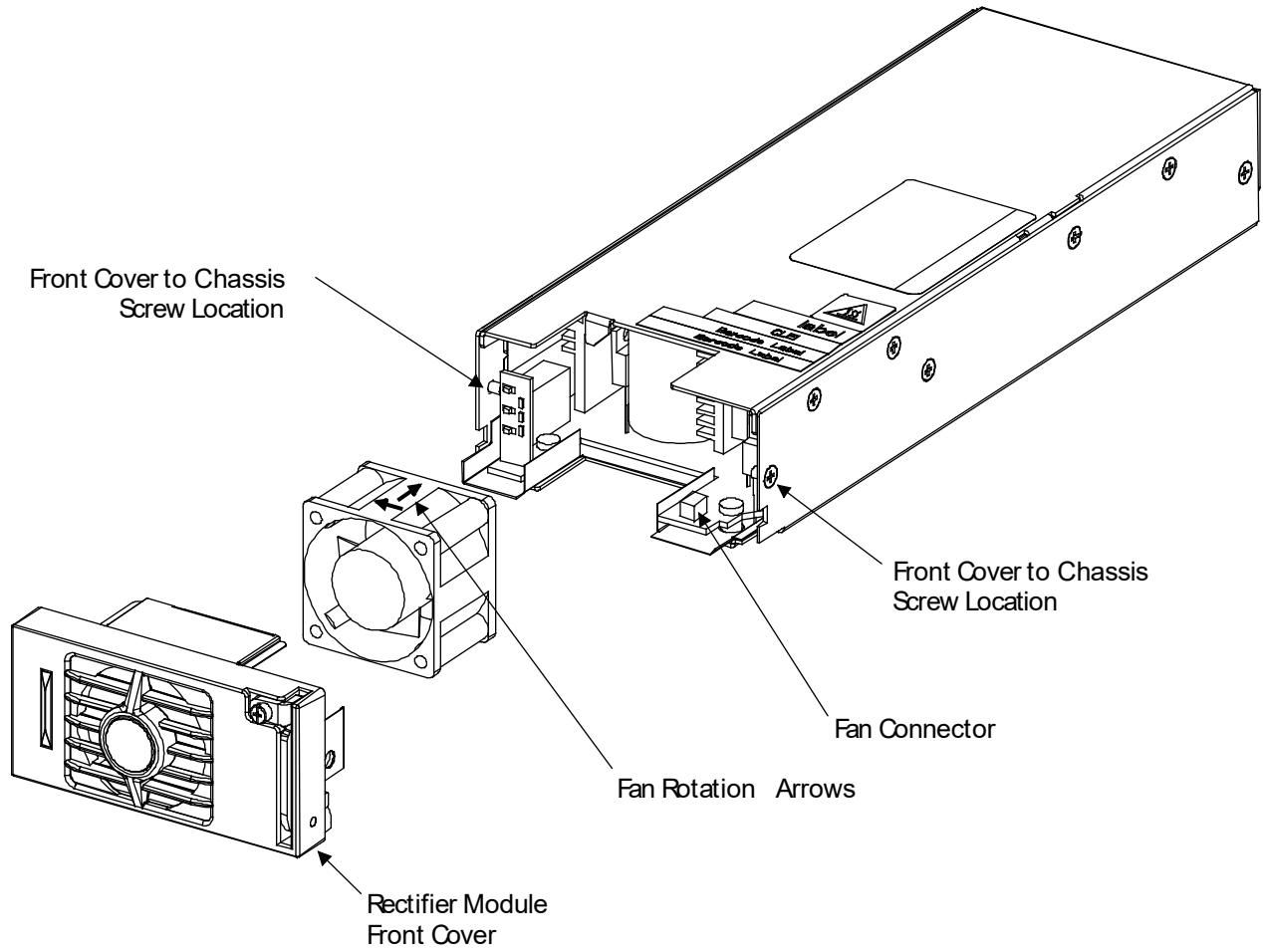

## Connect with Vertiv on Social Media



<https://www.facebook.com/vertiv/>



<https://www.instagram.com/vertiv/>



<https://www.linkedin.com/company/vertiv/>



<https://www.twitter.com/vertiv/>



---

Vertiv.com | Vertiv Headquarters, 505 N Cleveland Ave, Westerville, OH 43082, USA

© 2023 Vertiv Group Corp. All rights reserved. Vertiv™ and the Vertiv logo are trademarks or registered trademarks of Vertiv Group Corp. All other names and logos referred to are trade names, trademarks or registered trademarks of their respective owners. While every precaution has been taken to ensure accuracy and completeness here, Vertiv Group Corp. assumes no responsibility, and disclaims all liability, for damages resulting from use of this information or for any errors or omissions.